

ТИПОВЫЕ КОНСТРУКЦИИ, ИЗДЕЛИЯ И УЗЛЫ ЗДАНИЙ И СООРУЖЕНИЙ

СЕРИЯ 1.020.1-4

КОНСТРУКЦИИ РАМНОГО КАРКАСА МЕЖВИДОВОГО ПРИМЕНЕНИЯ
ДЛЯ МНОГОЭТАЖНЫХ ОБЩЕСТВЕННЫХ ЗДАНИЙ, ПРОИЗВОДСТВЕННЫХ
И ВСПОМОГАТЕЛЬНЫХ ЗДАНИЙ ПРОМЫШЛЕННЫХ ПРЕДПРИЯТИЙ

выпуск 0-9

УКАЗАНИЯ ПО ПОДБОРУ ЭЛЕМЕНТОВ КАРКАСА.

(Вариант армирования изделий сталью классов Ат-IVС и Врп-I).

часть 2

СТР.12-239

Книга 1

СТР.(112-175)

НАЧАЛО

24 166-02

ЦЕНА 9-88

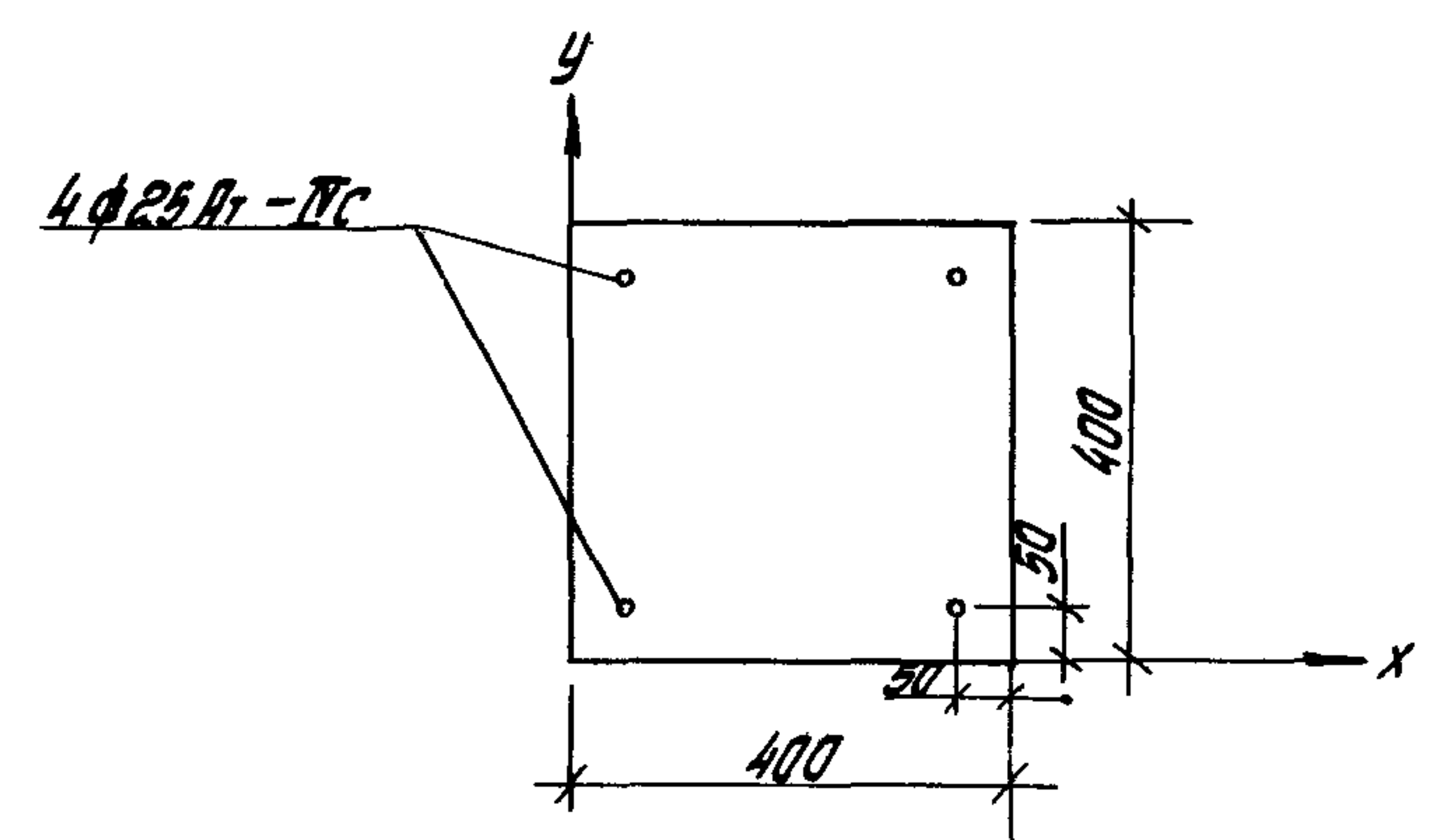
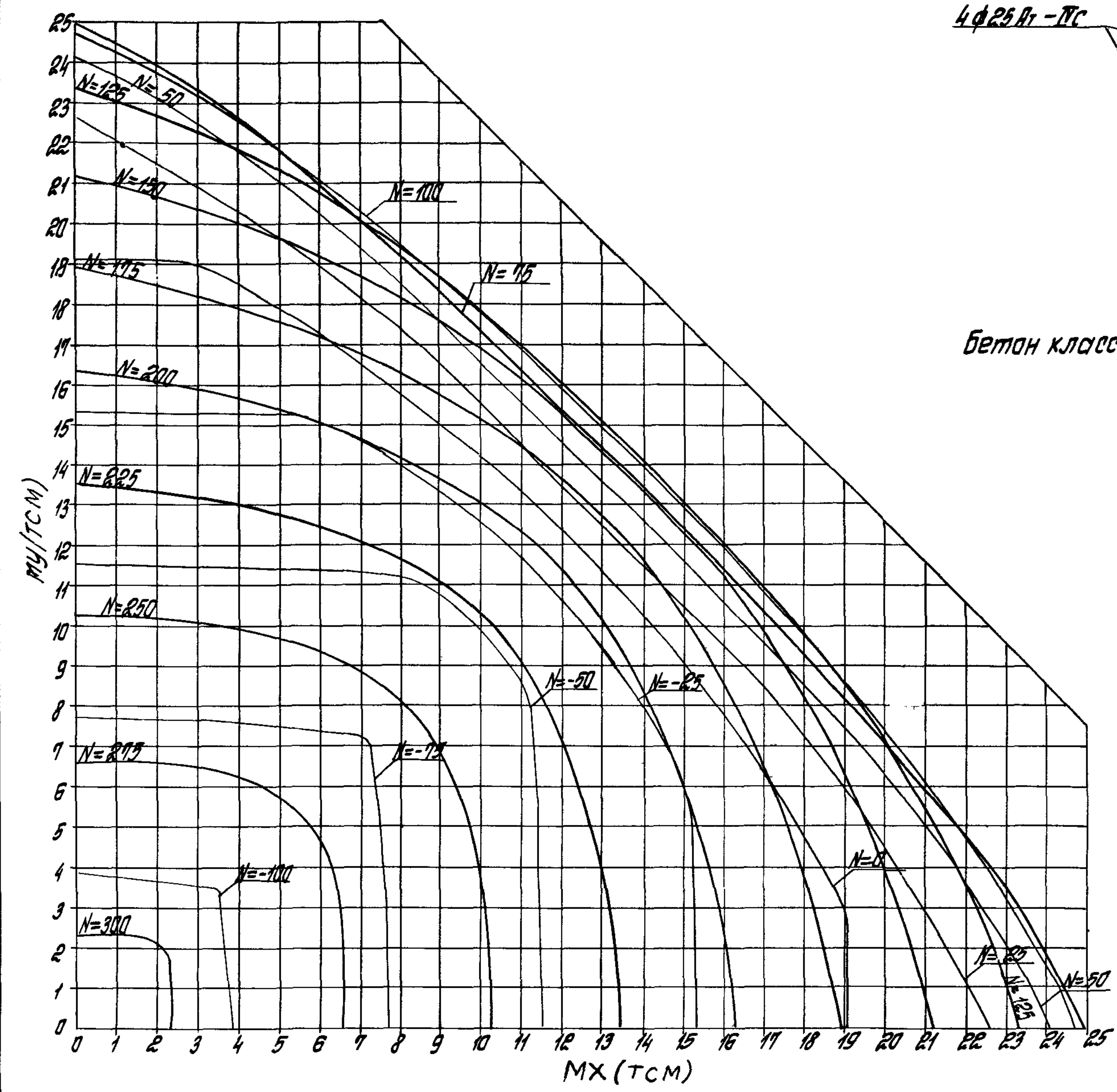

Бетон класса В22,5 ($R_{B2} = 14,3$ МПа при учете $\gamma_{B2} = 1,10$)
 Сталь класса А1-IVC
 Код сечения -113а

1.020.1-4 0-9 002

Лист
97

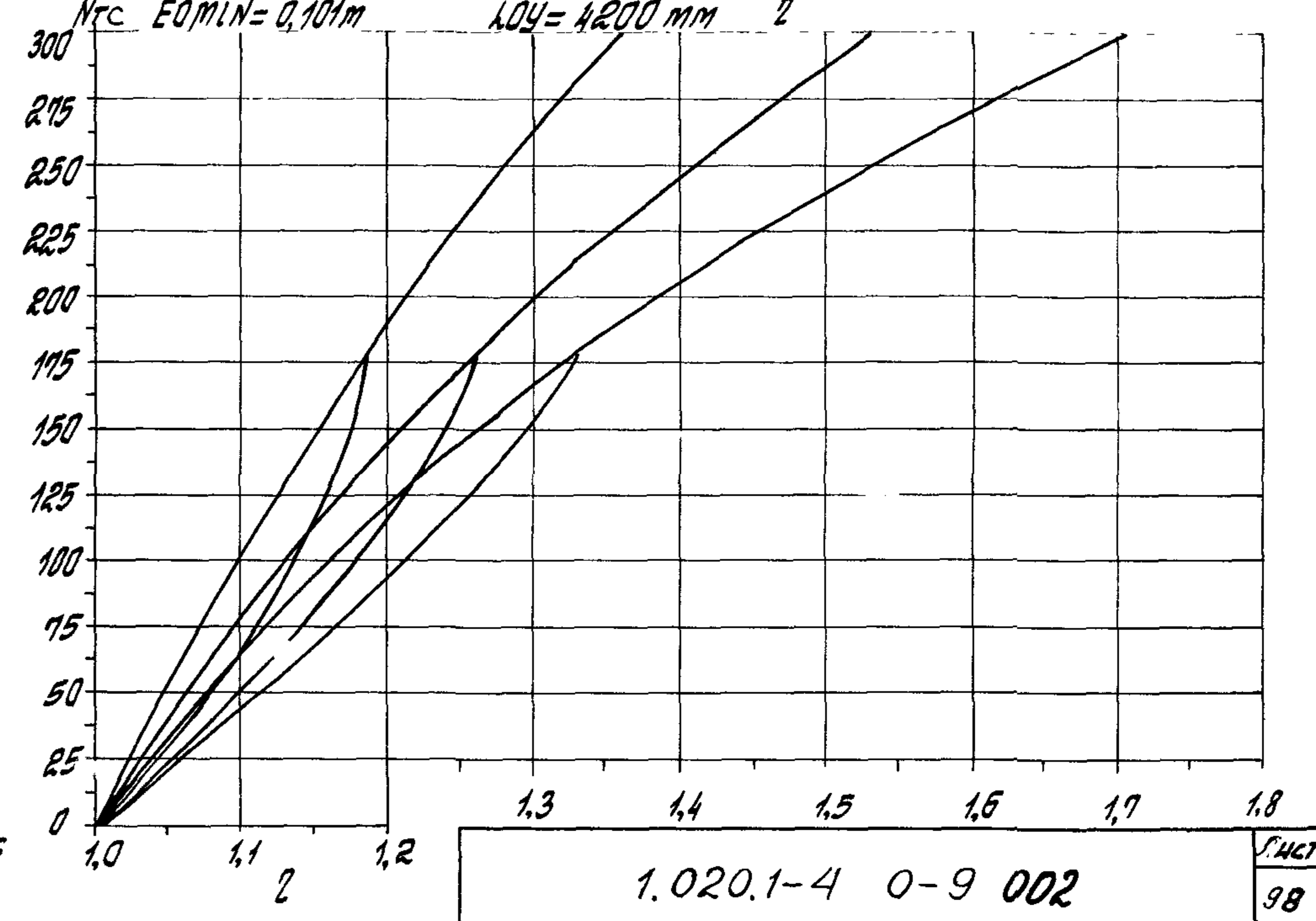
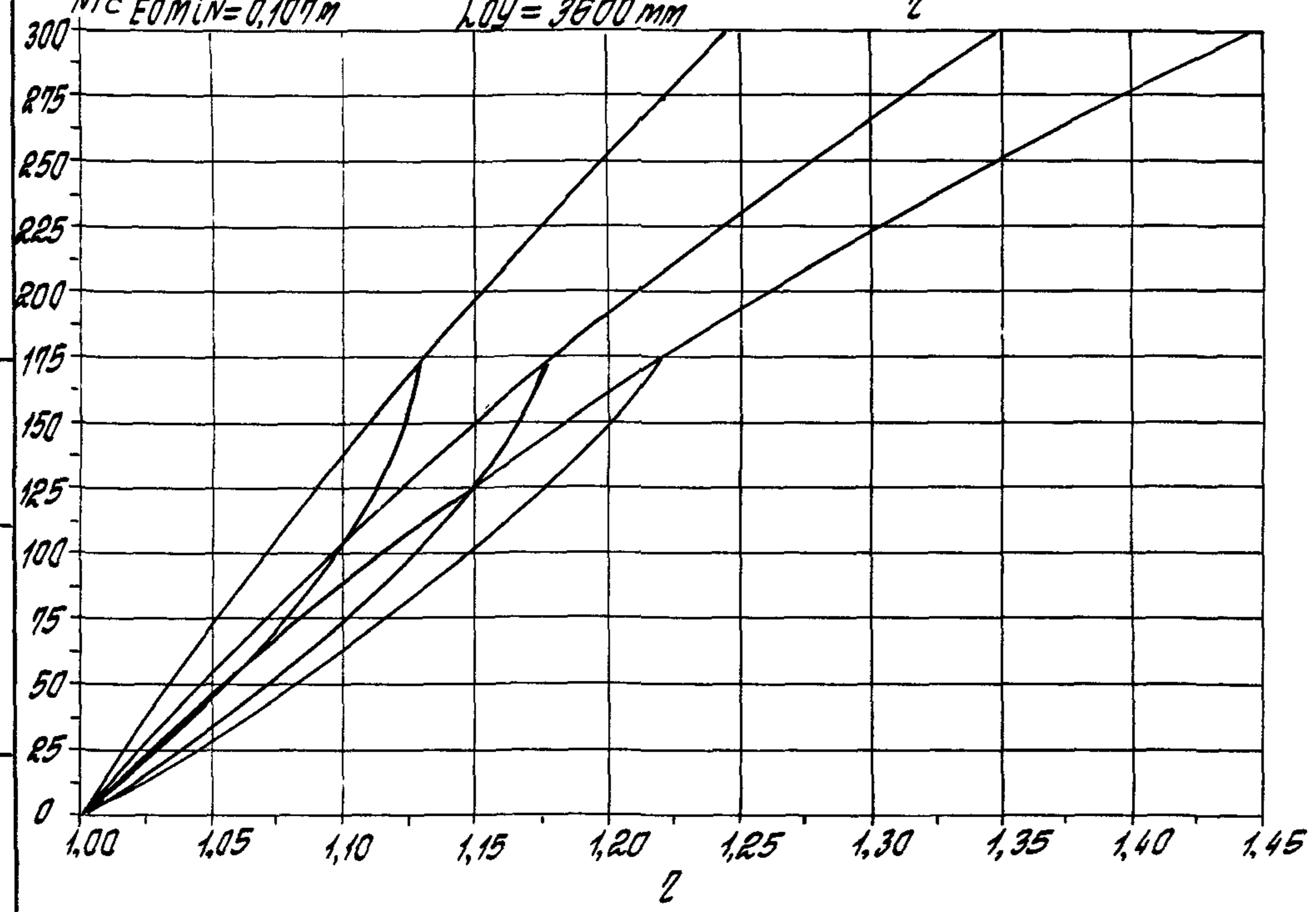
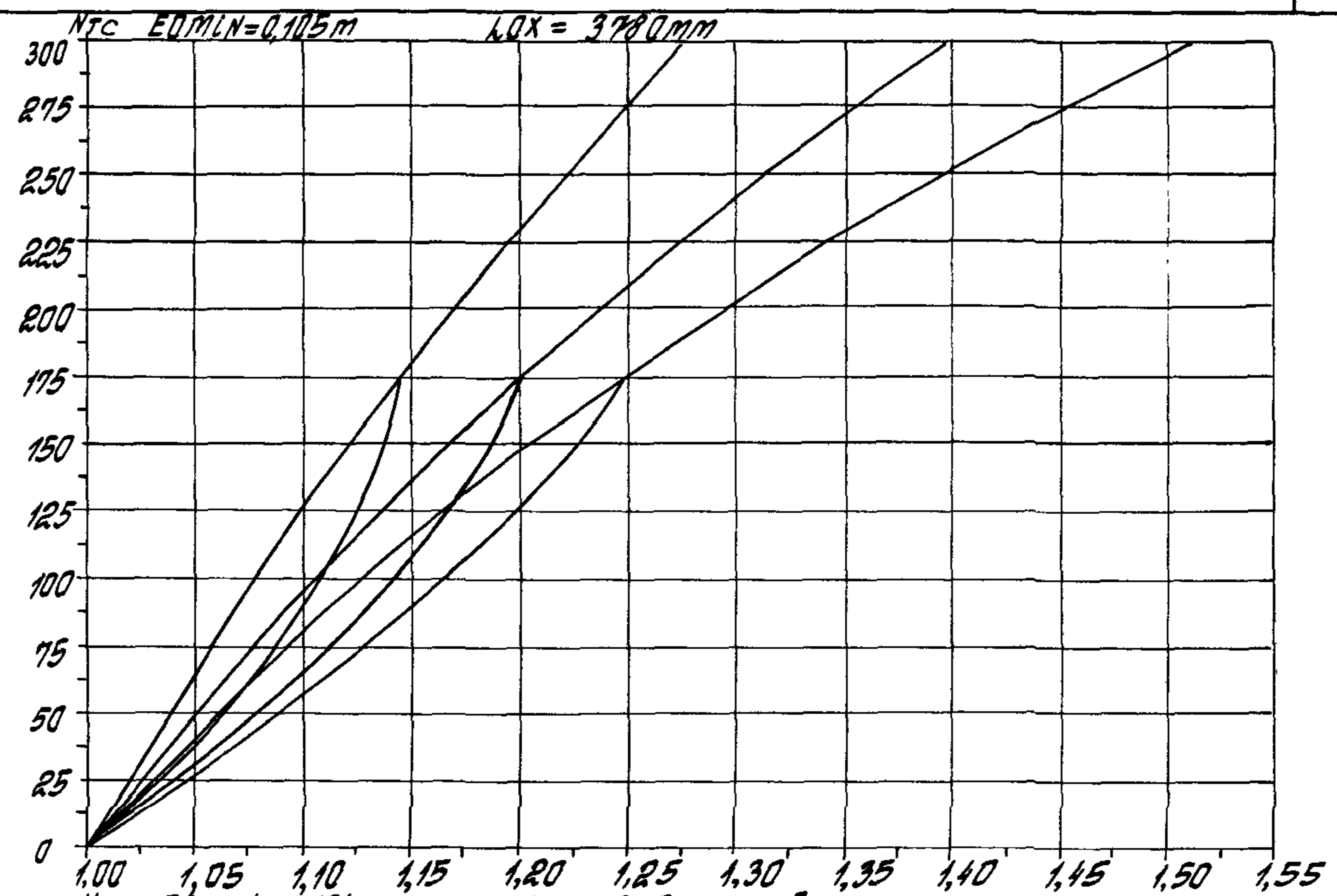
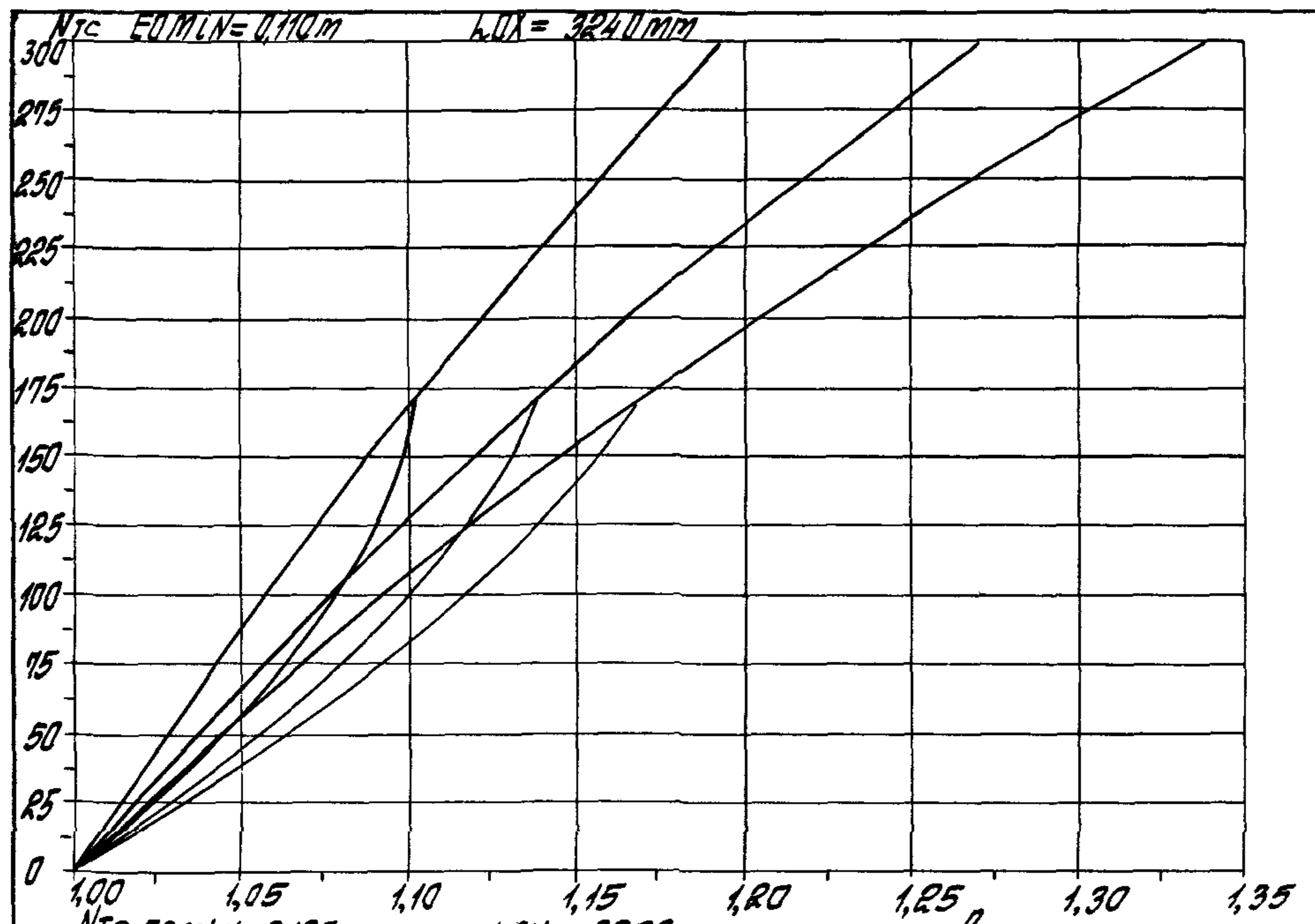

1.020.1-4 0-9 002

Л.И.С.Т. 98

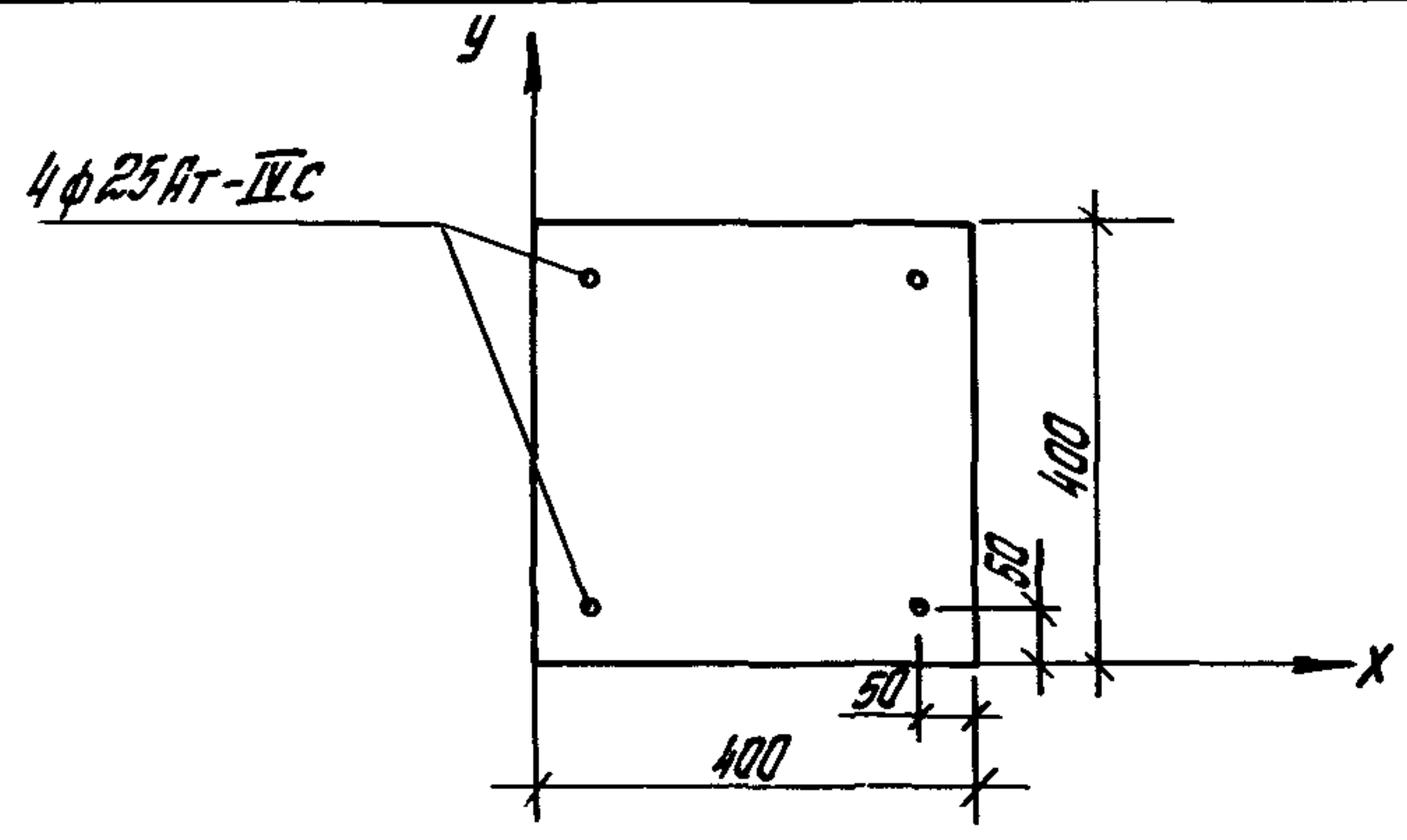
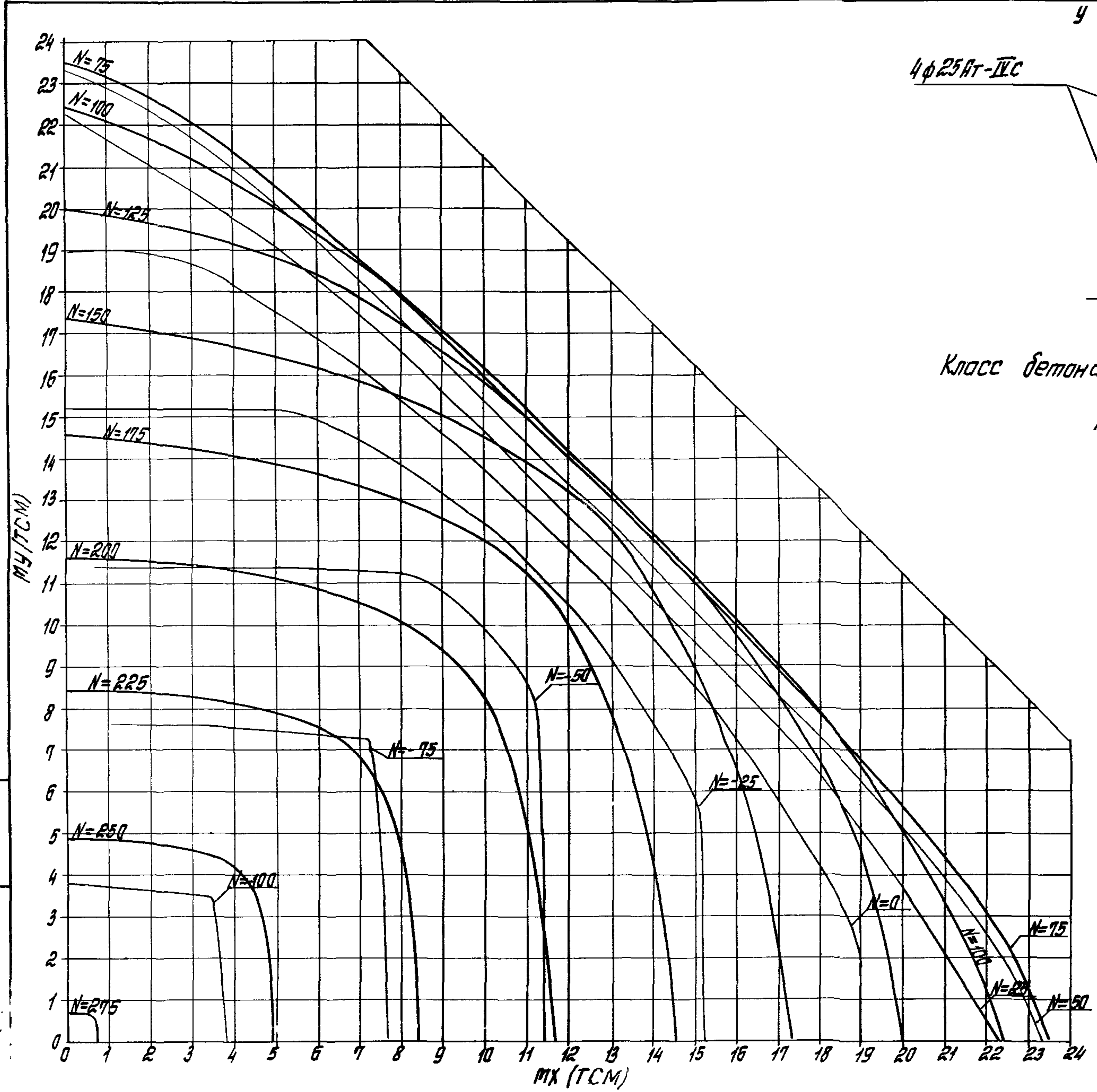

Класс бетона $B=22.5$ ($R_b = 11,7 \text{ МПа}$ при учете $\gamma_{b2} = 0,90$)
 Сталь АТ-IVС
 Код сечения -113Б

1.020. 1-4 0-9 002

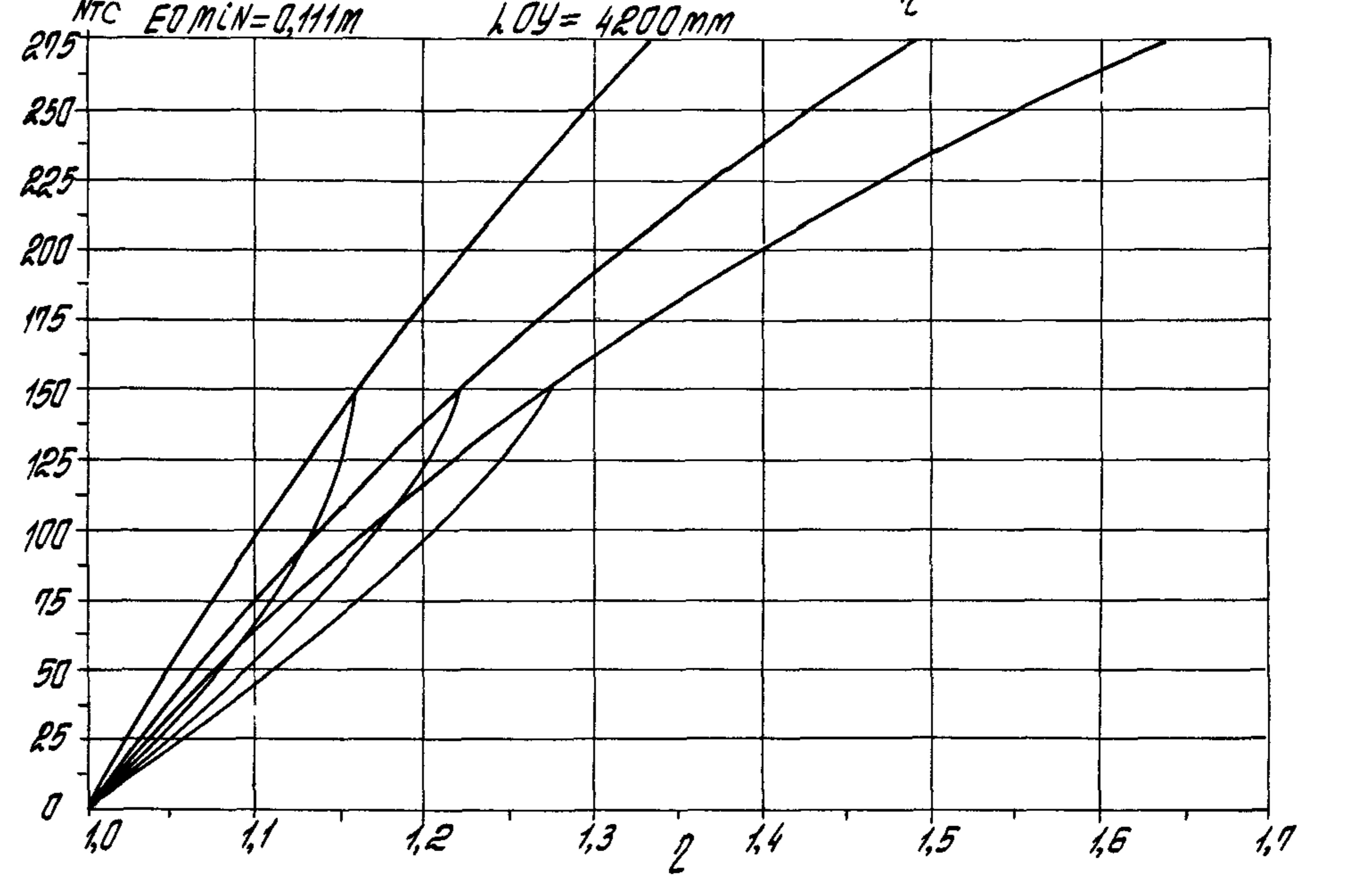
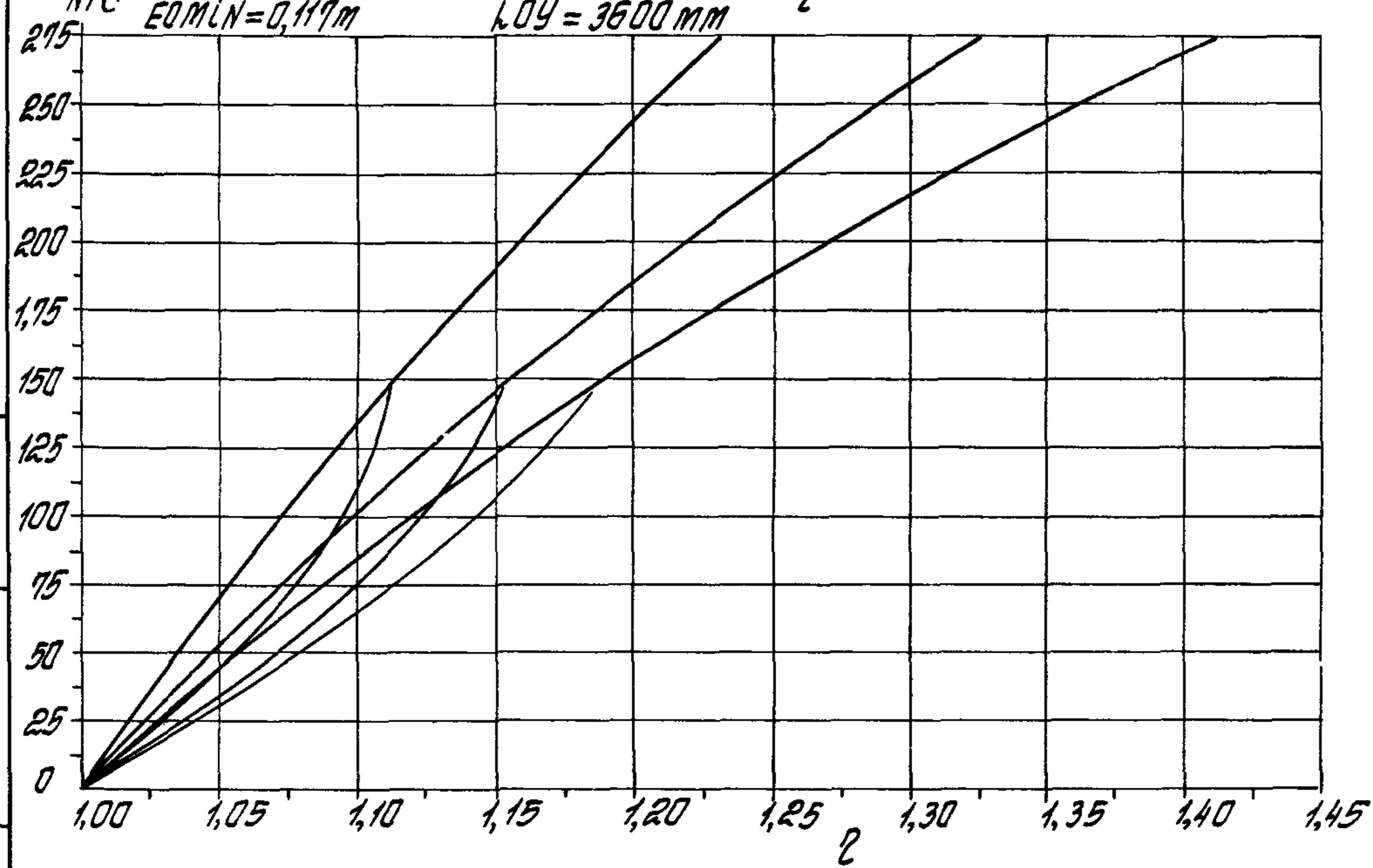
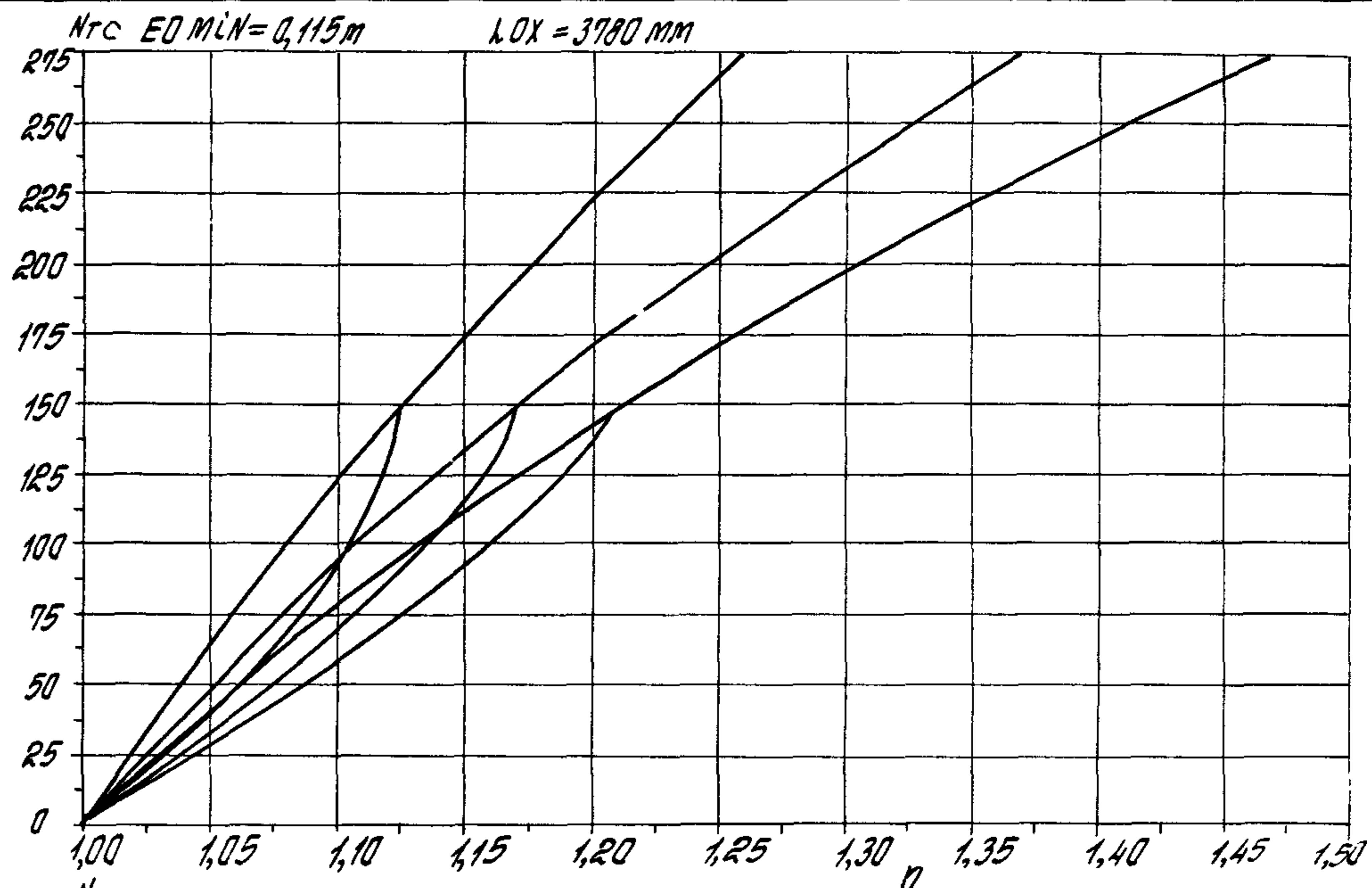
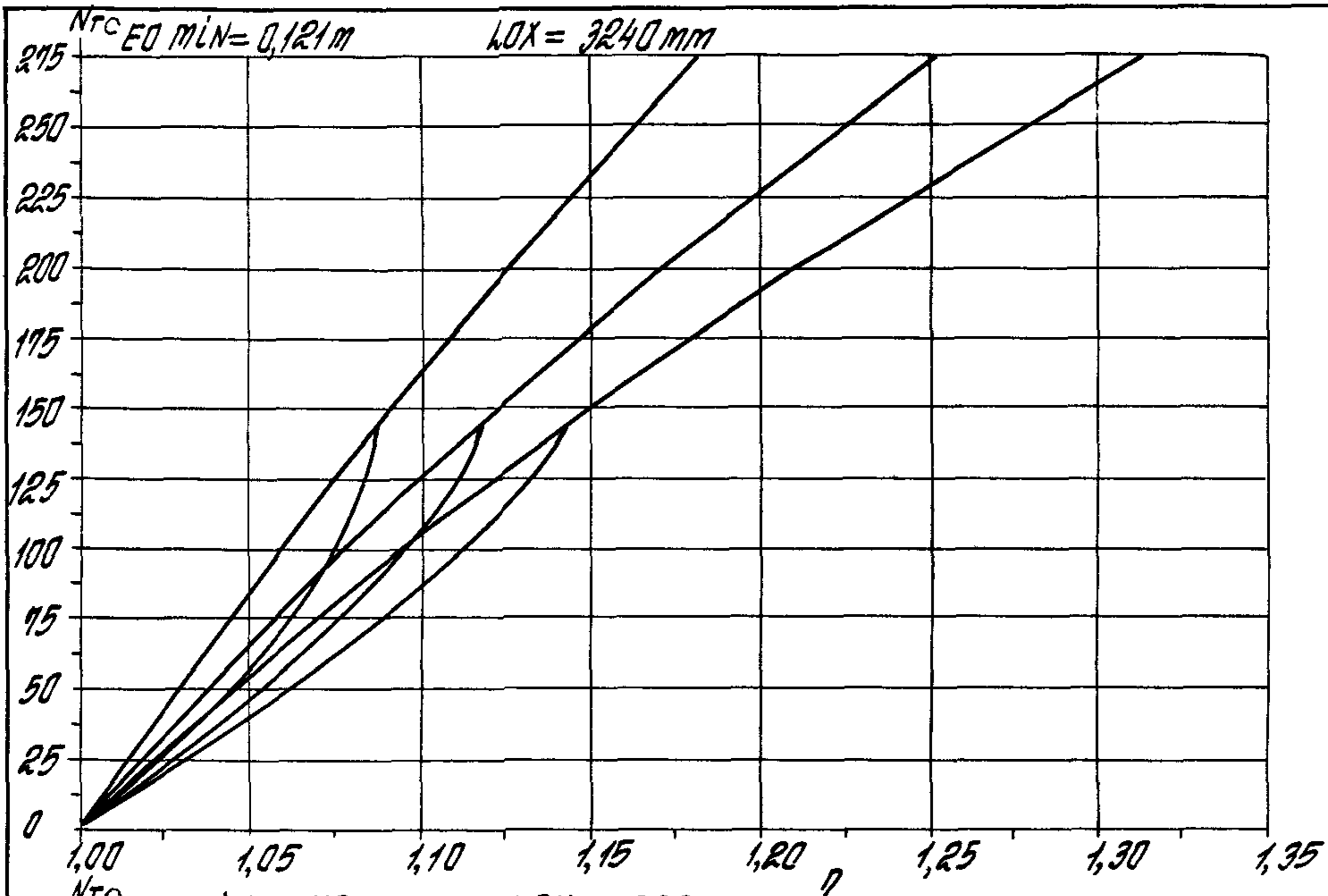

Лист № 1000. Видового листа. Взам. штаб. №

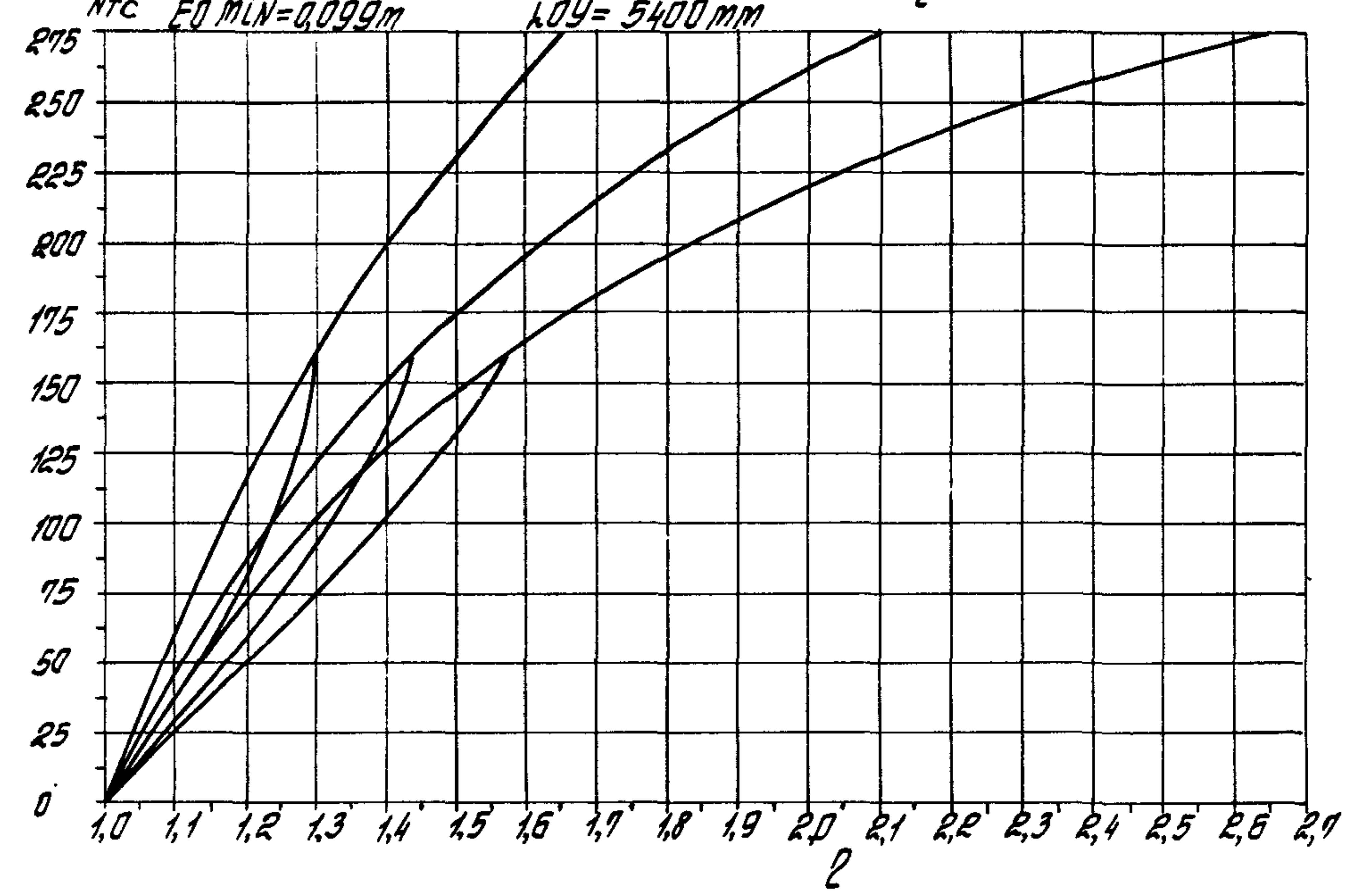
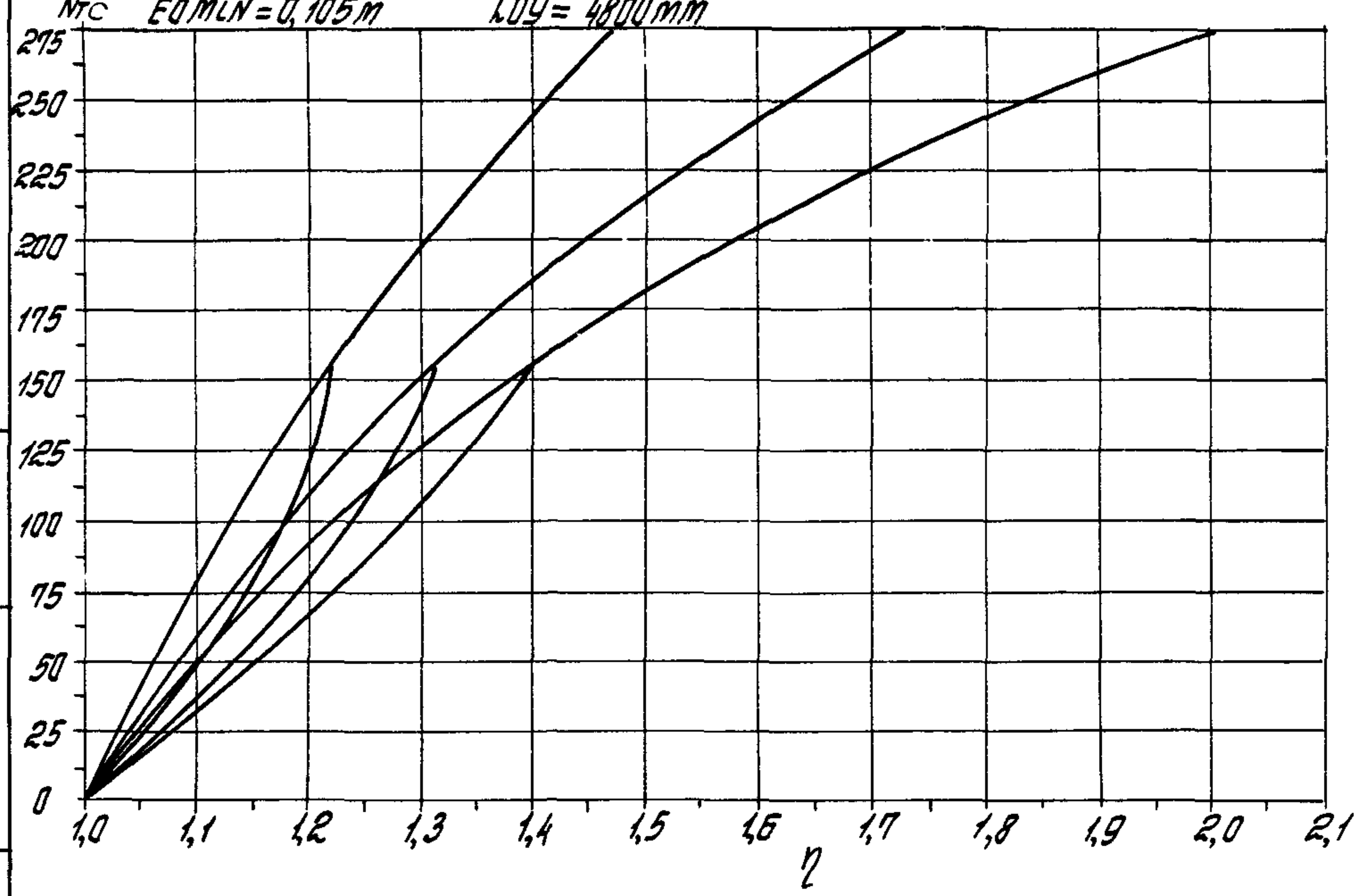
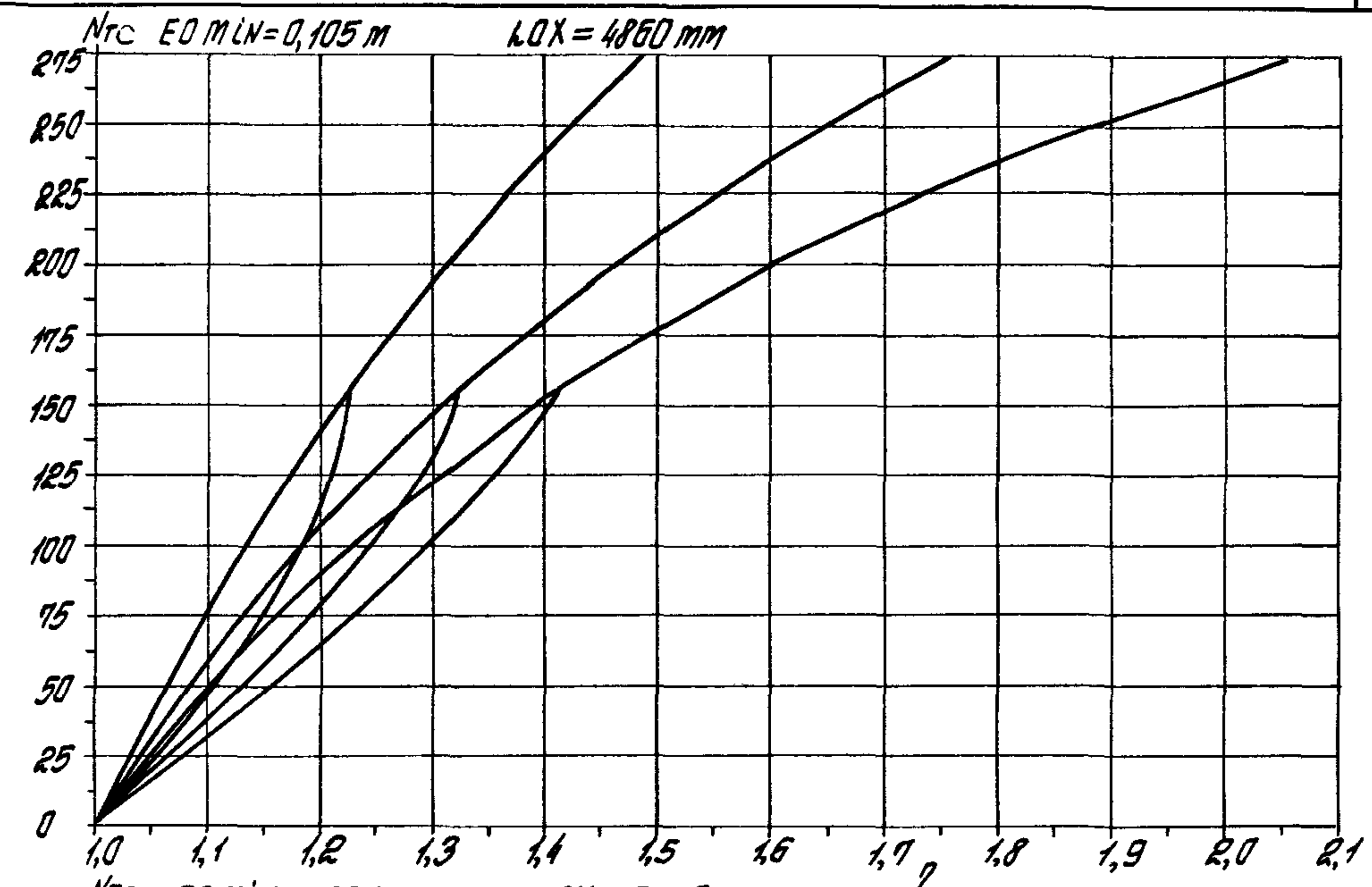
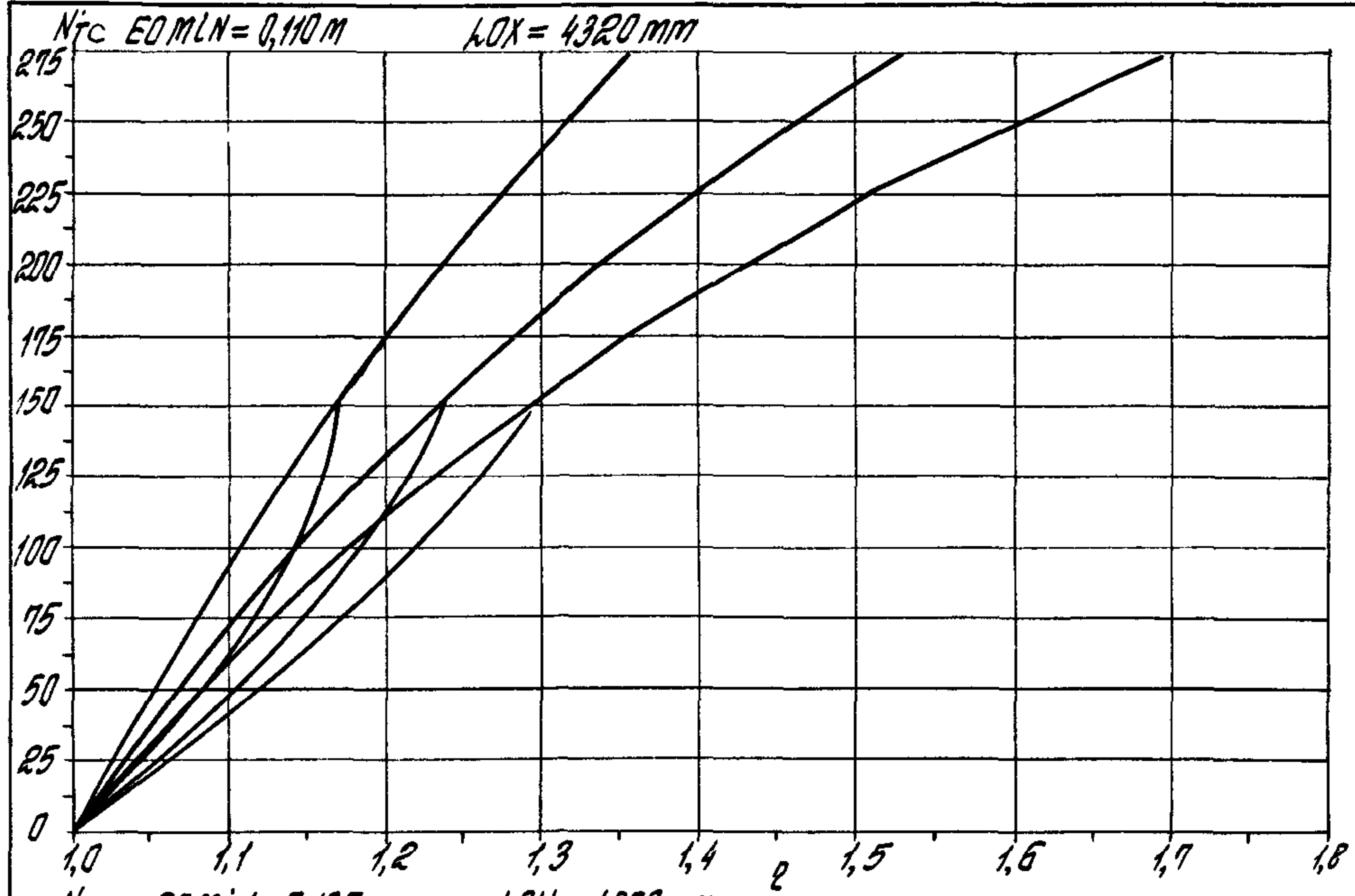

1.020.1-4

1.020.1-4 0-9 002 103

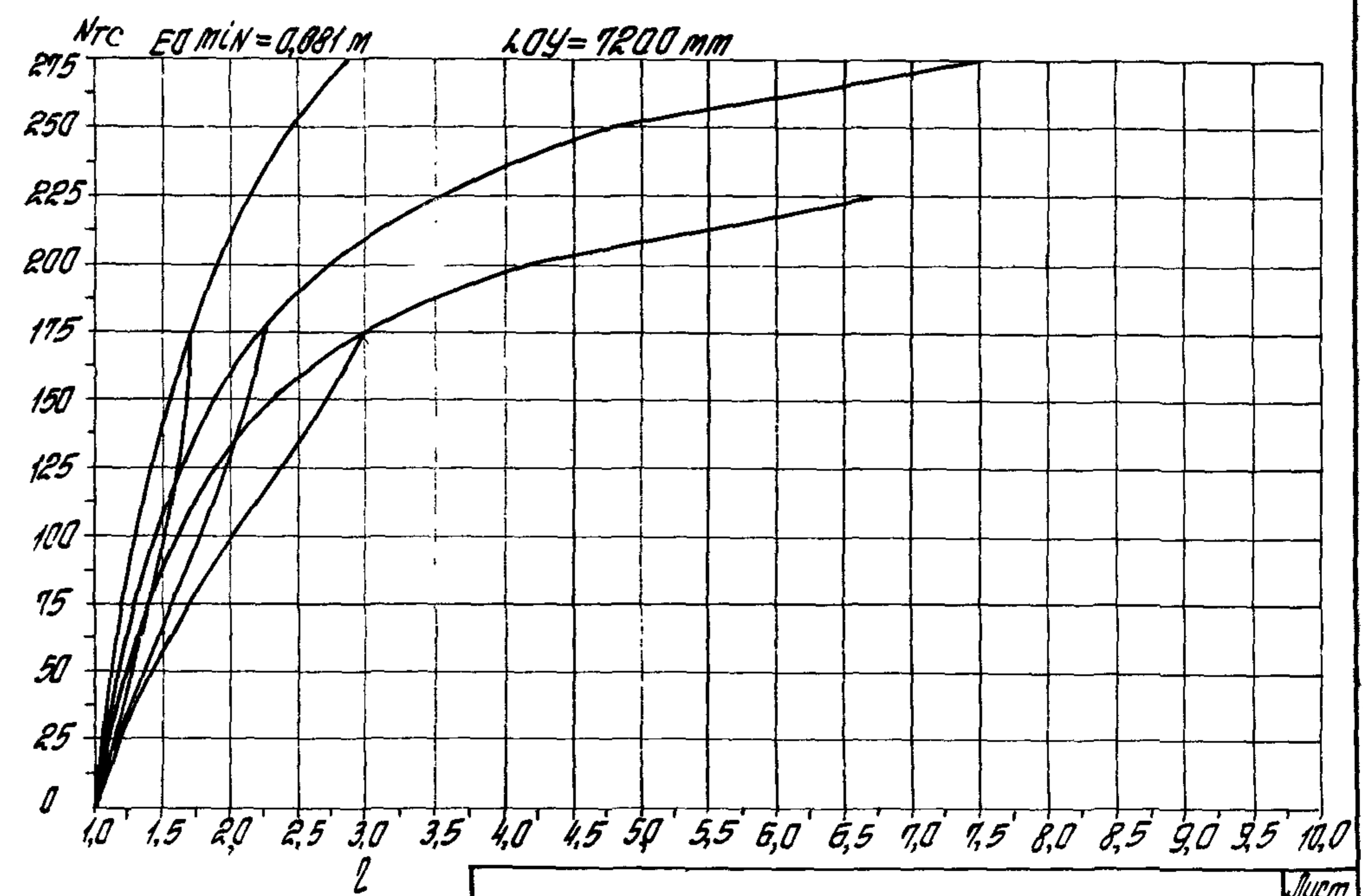
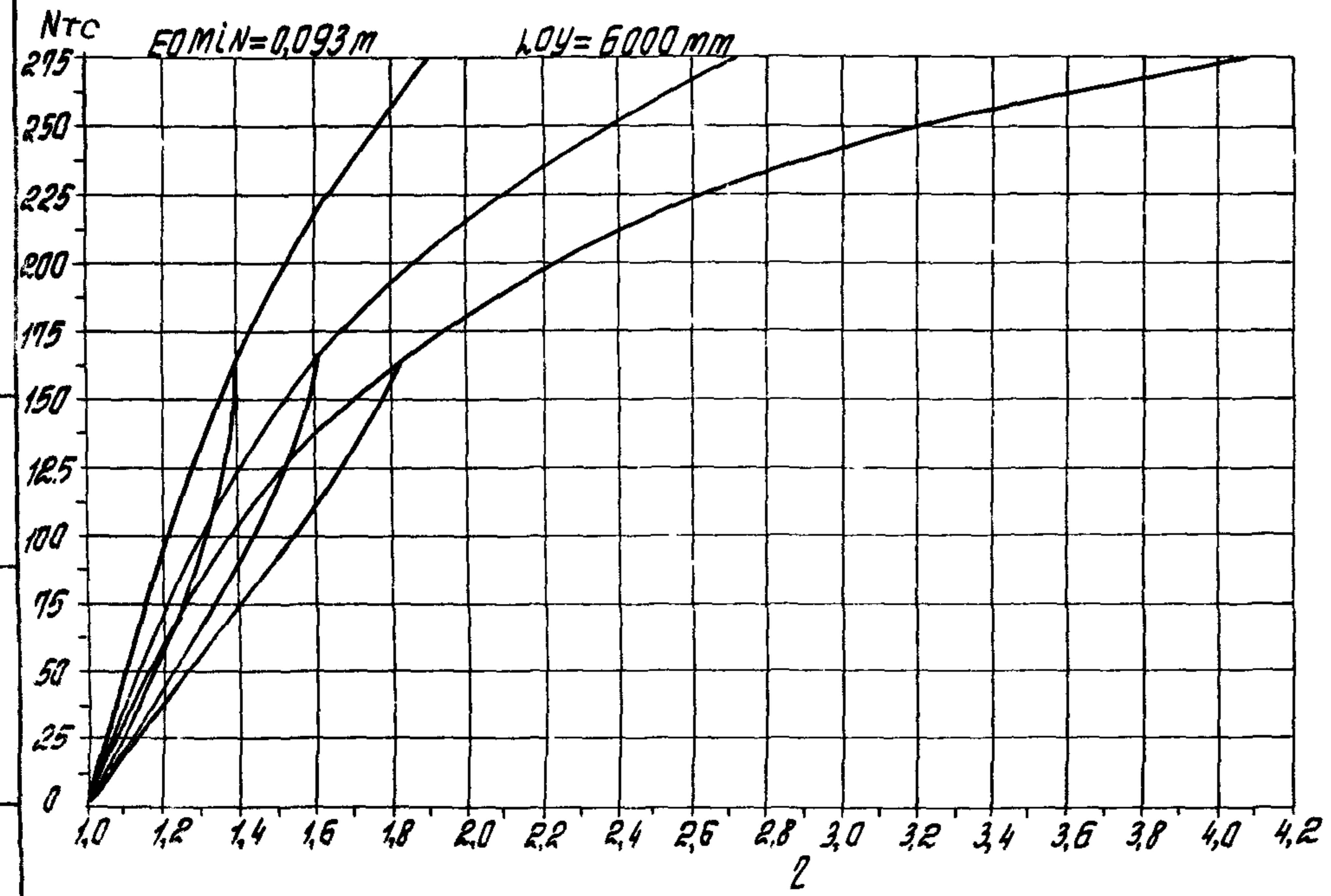
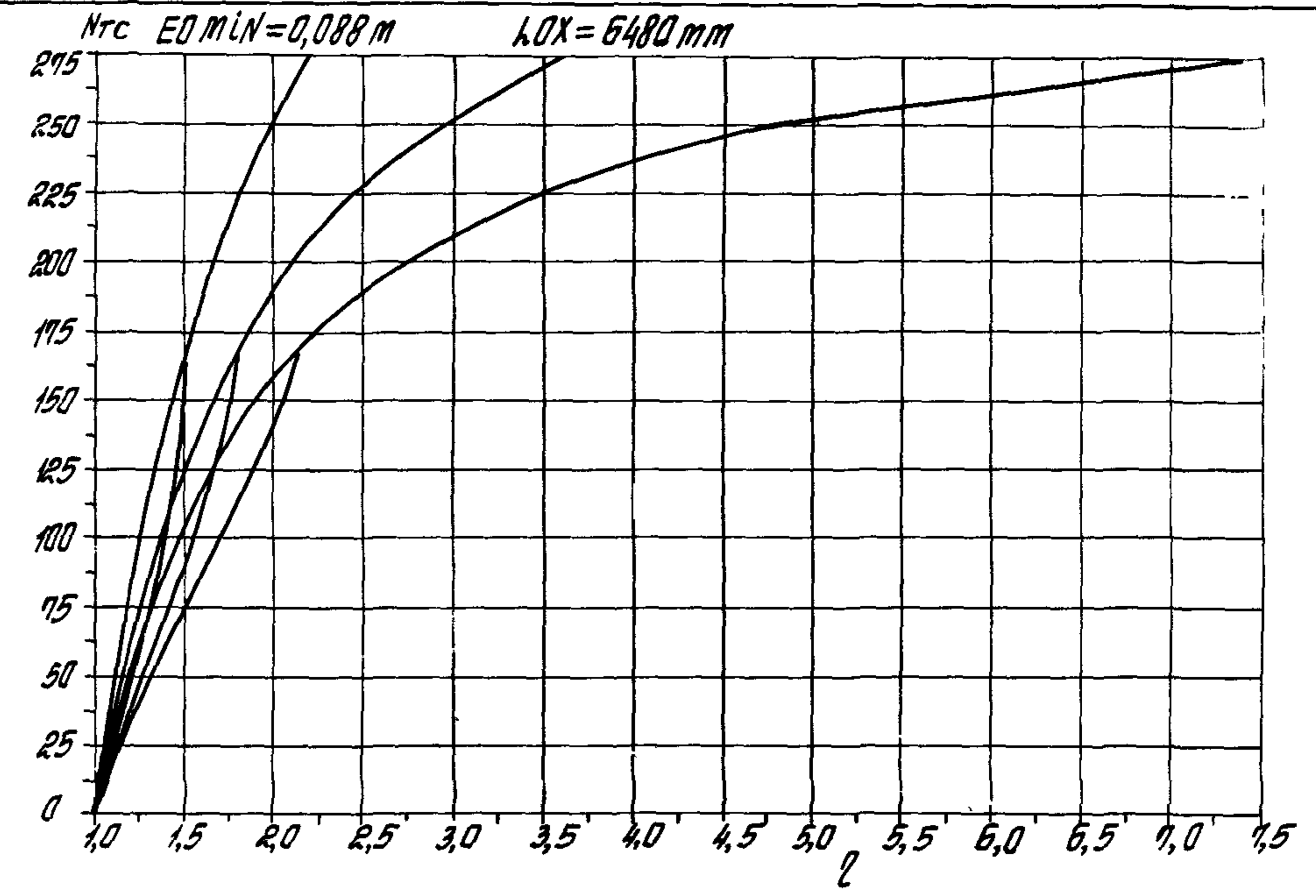
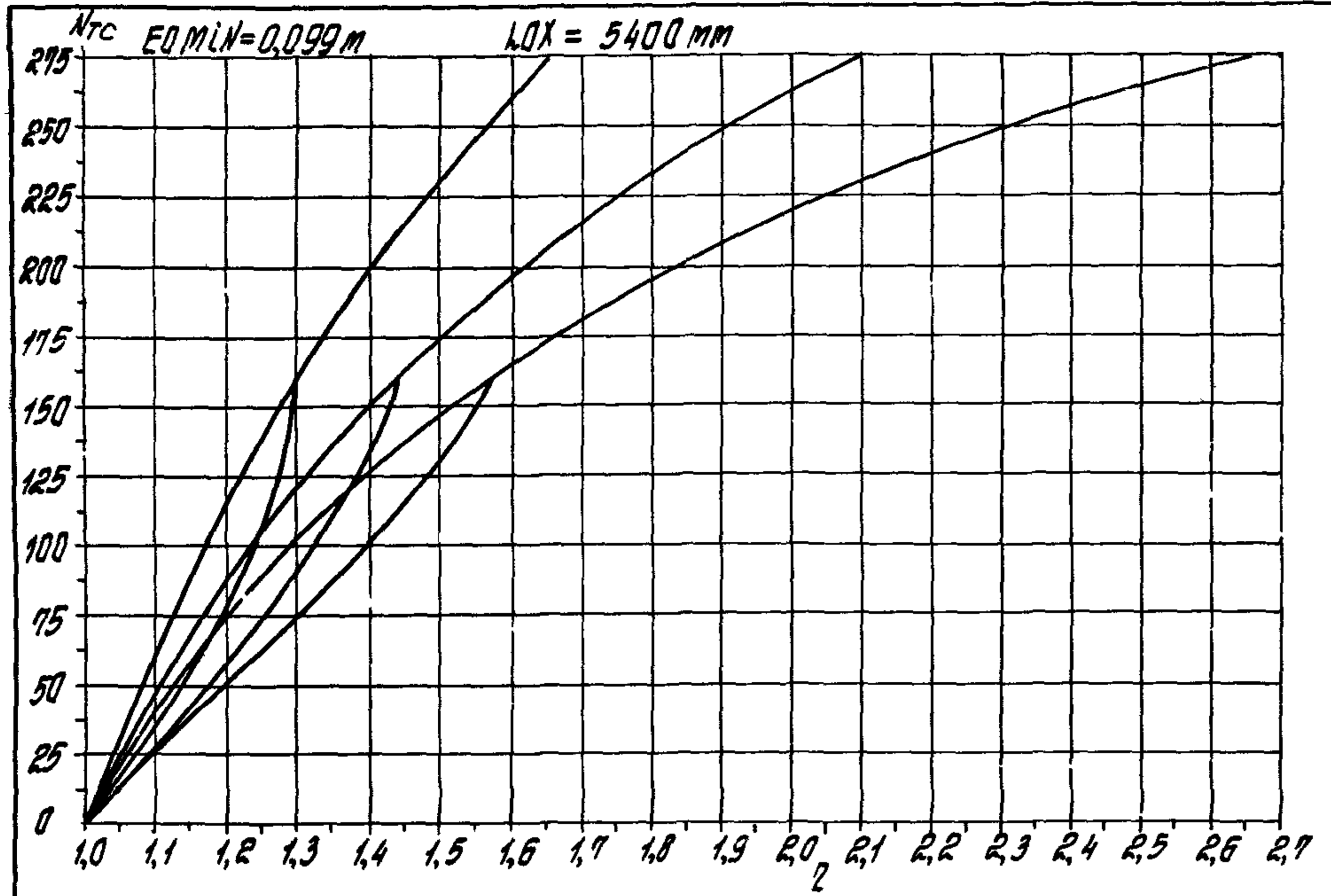

УЧБ. № 1040
 Институт Ученых
 СССР. Учен.

1.020. 1-4 0-9 002 104

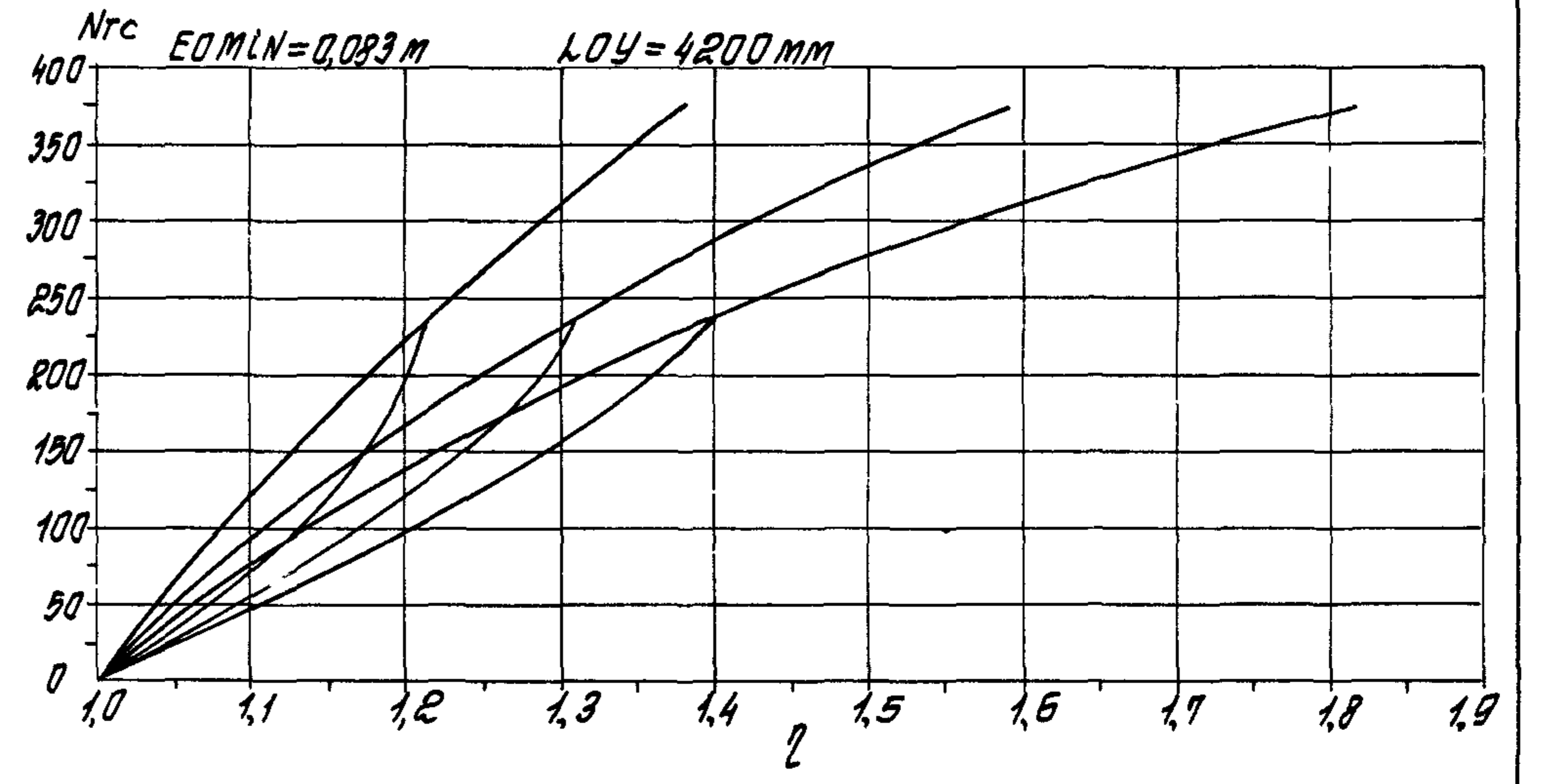
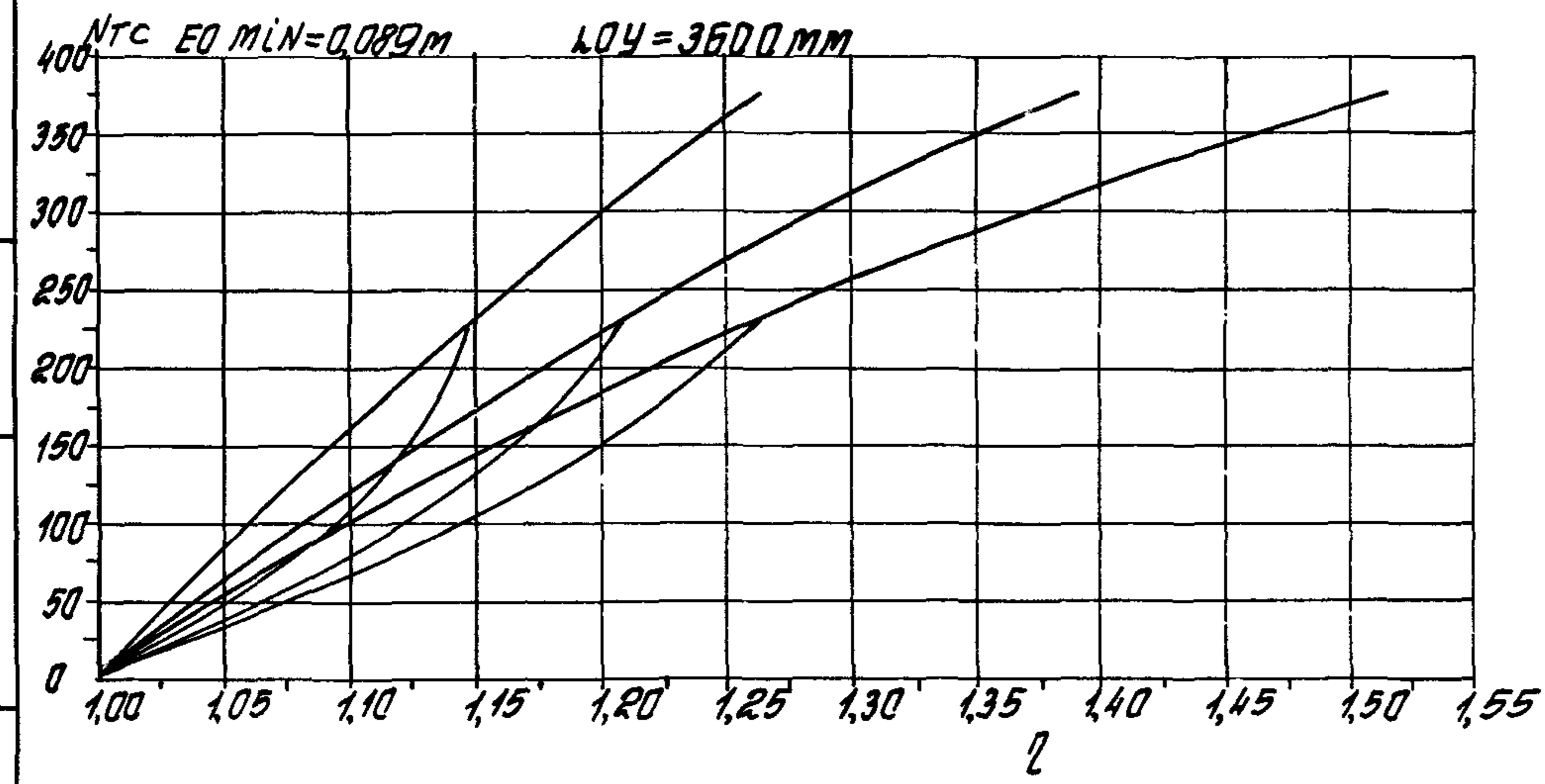
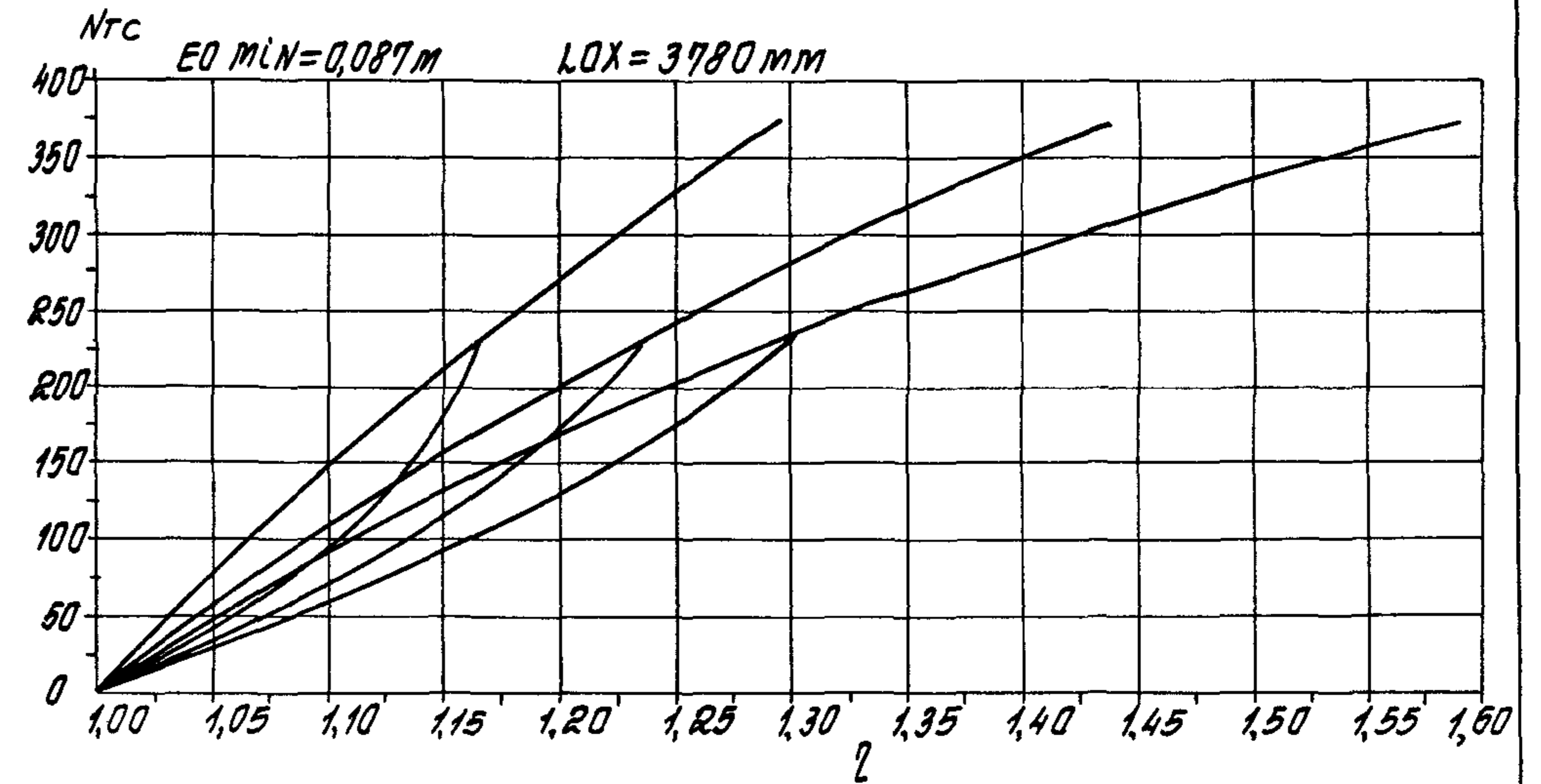
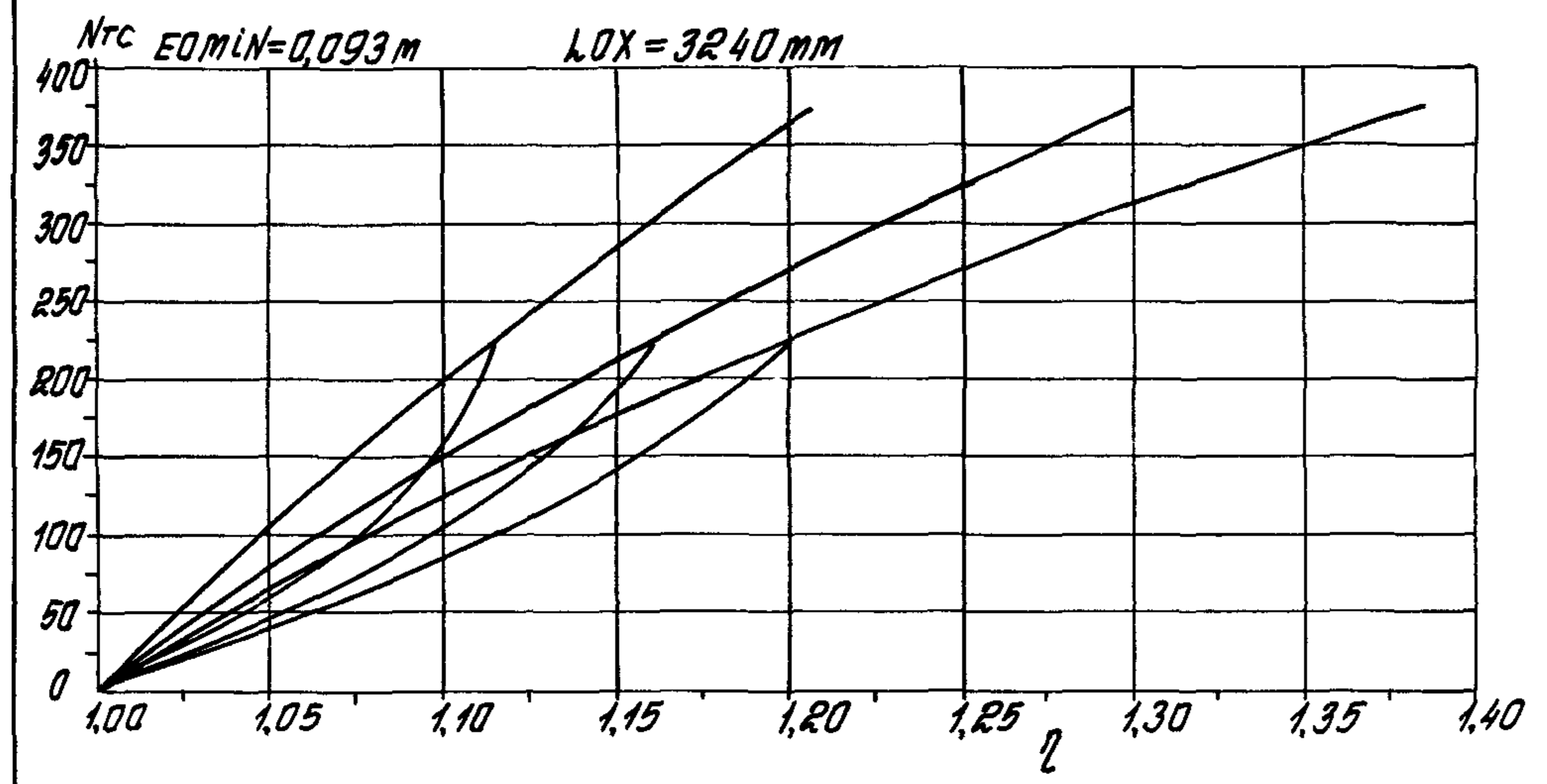

УНТ № 1000. Подпись и дата. Взам. инв. №

1.020. 1-4 0-9 002 Лист 106

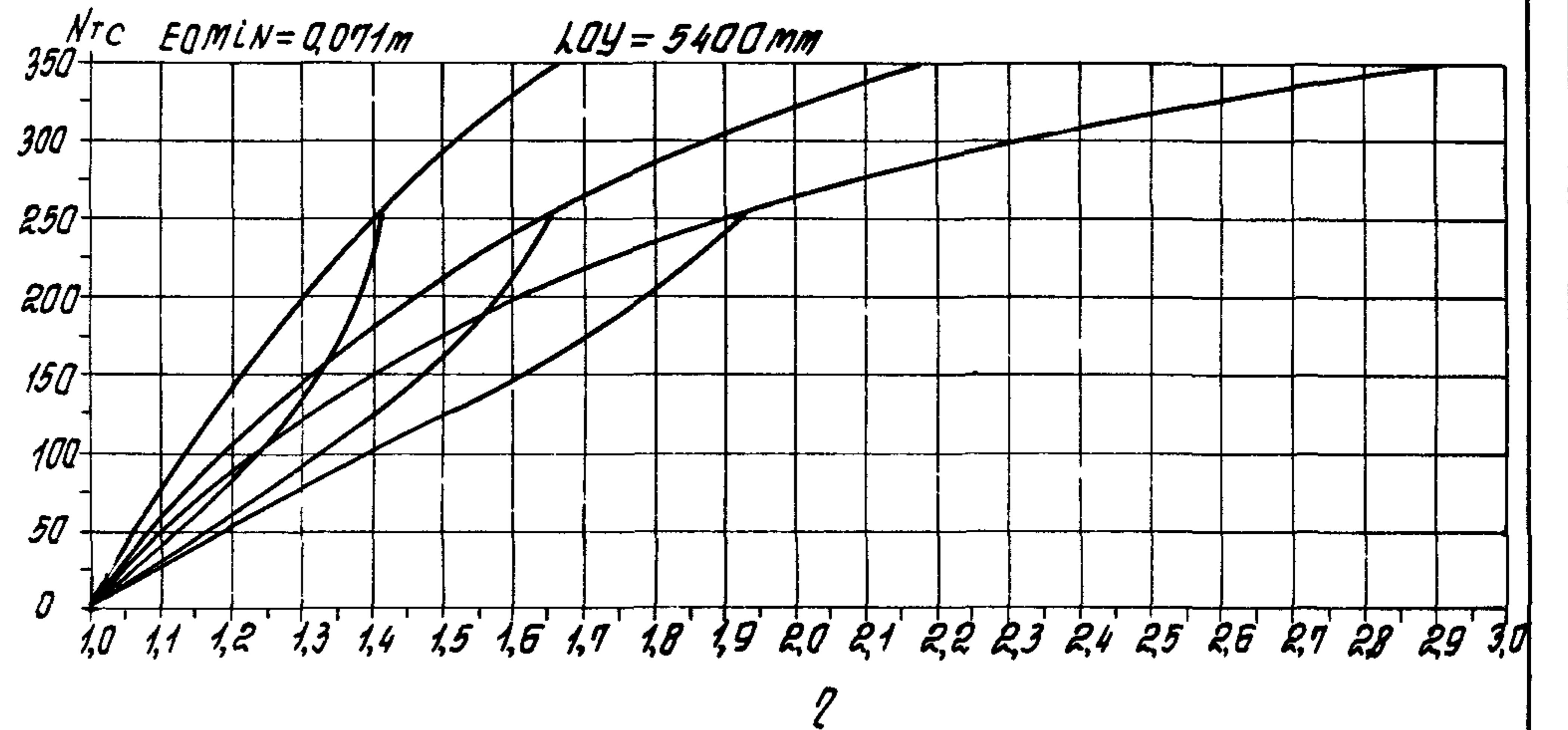
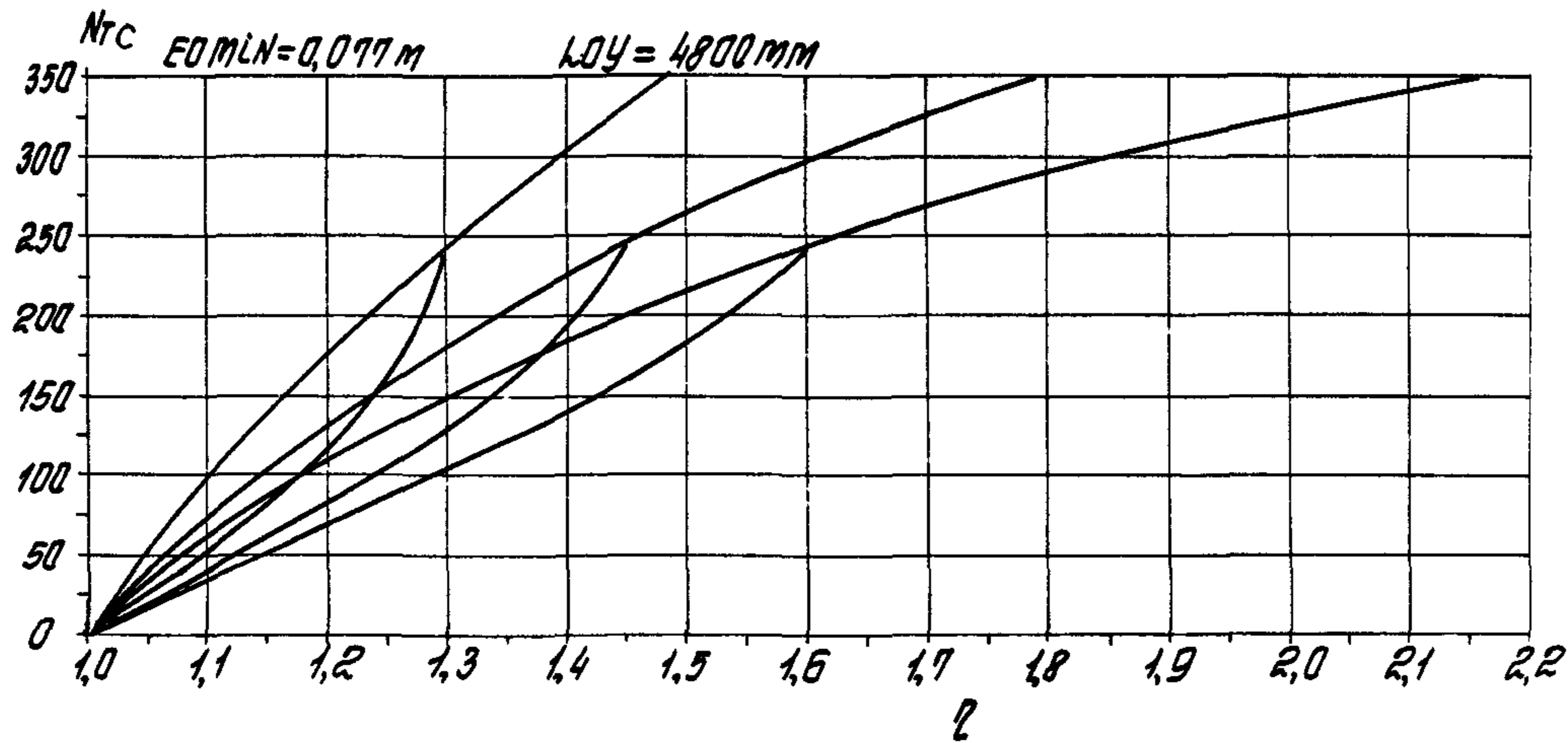
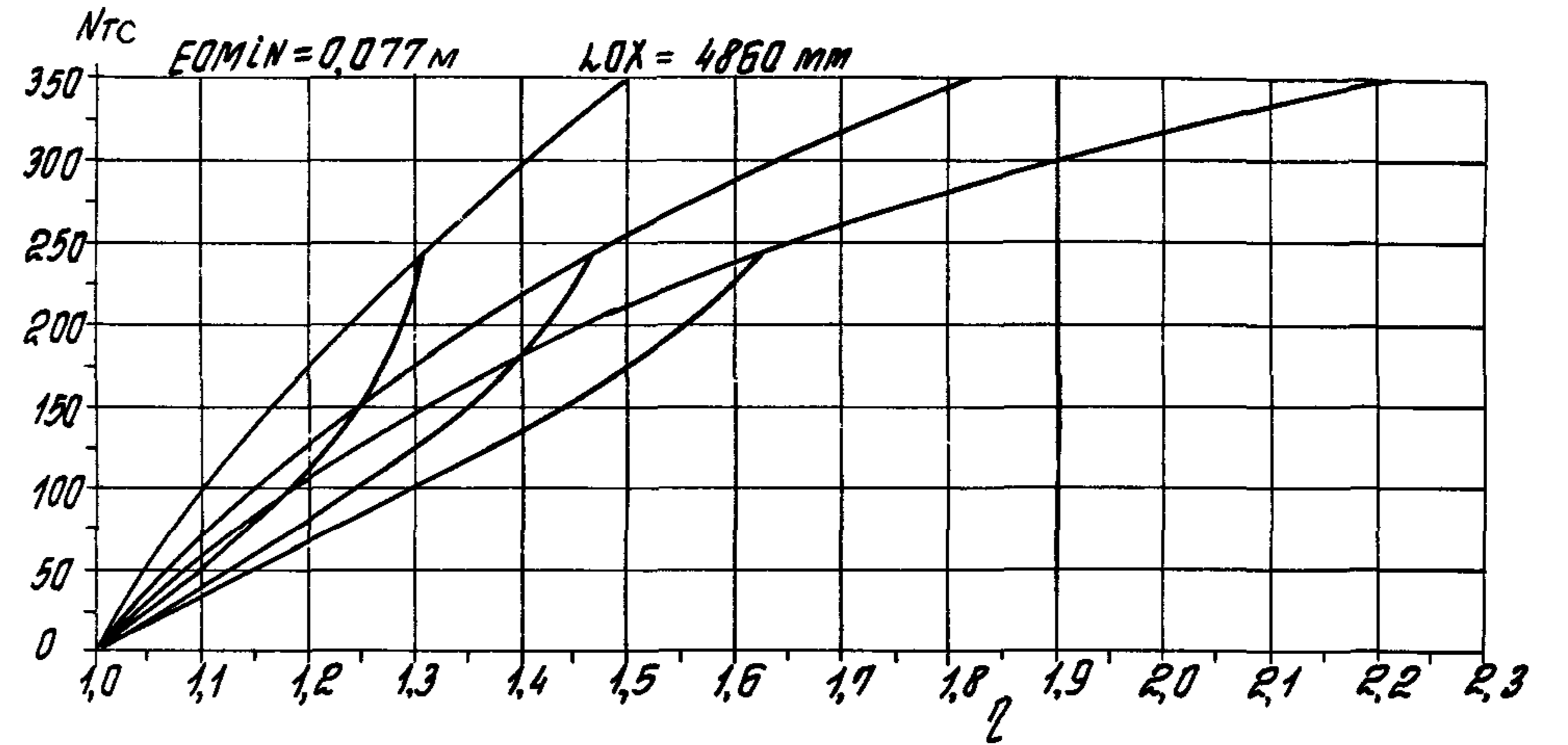
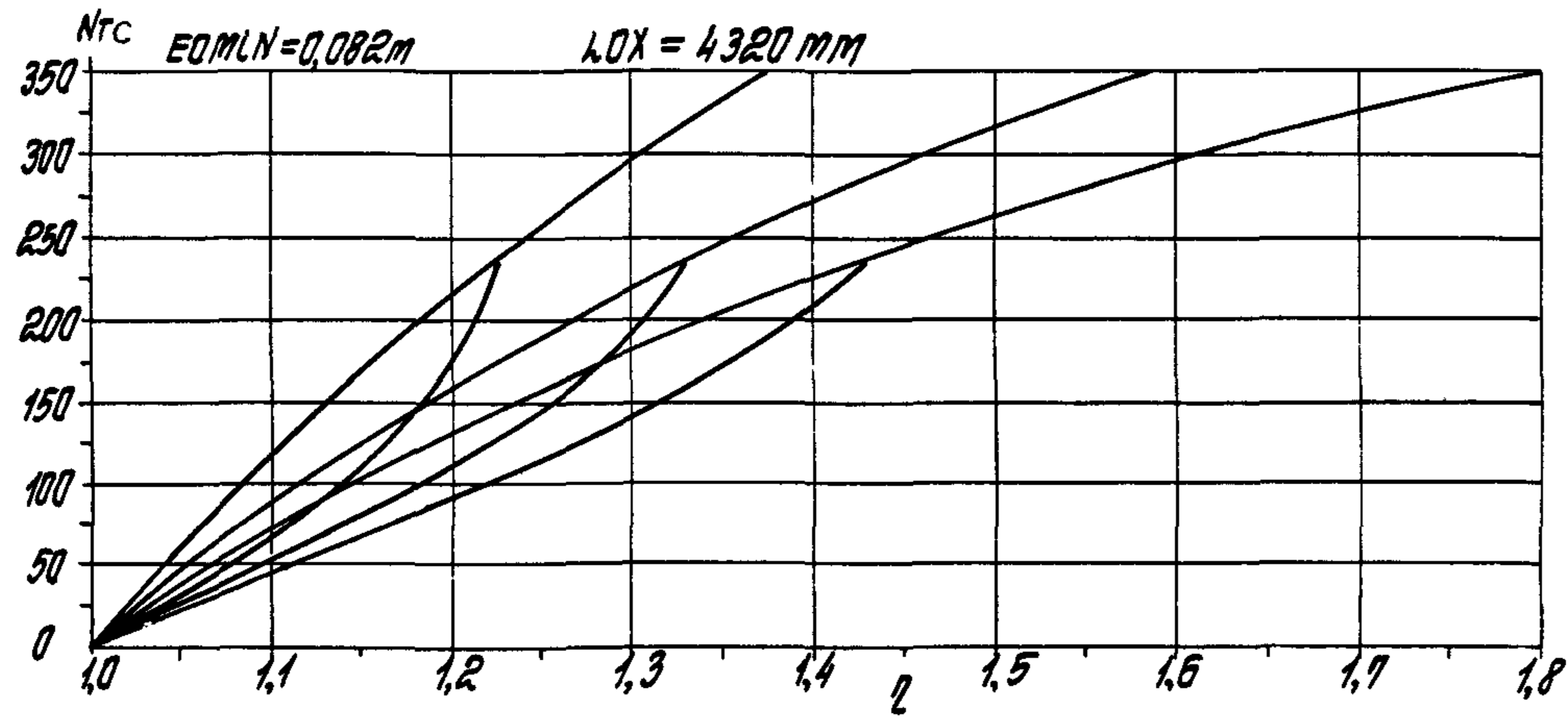

УНЧ № 1070 / Подпись и дата / Итого / Шкала

1.020. 1-4	0-9 002	Итого 107
------------	---------	--------------

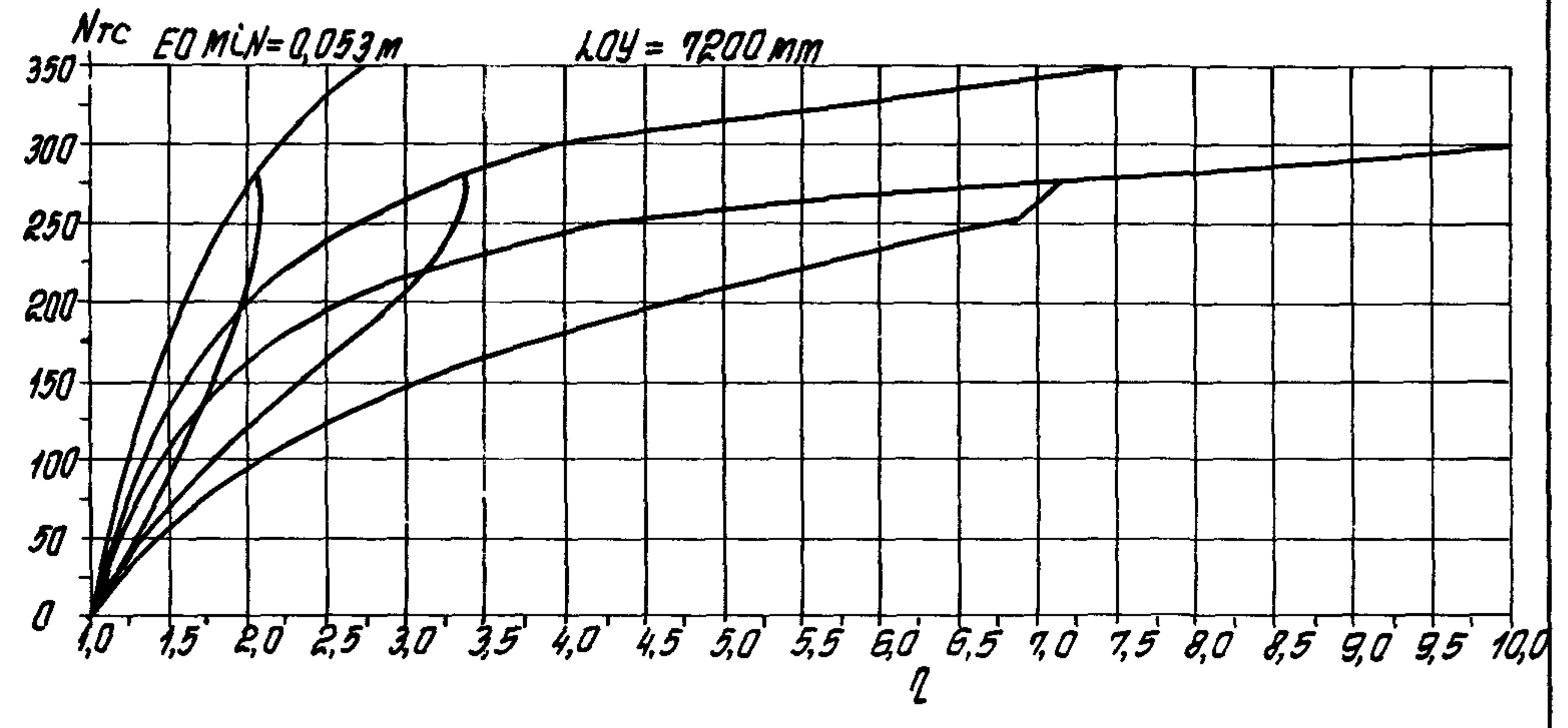
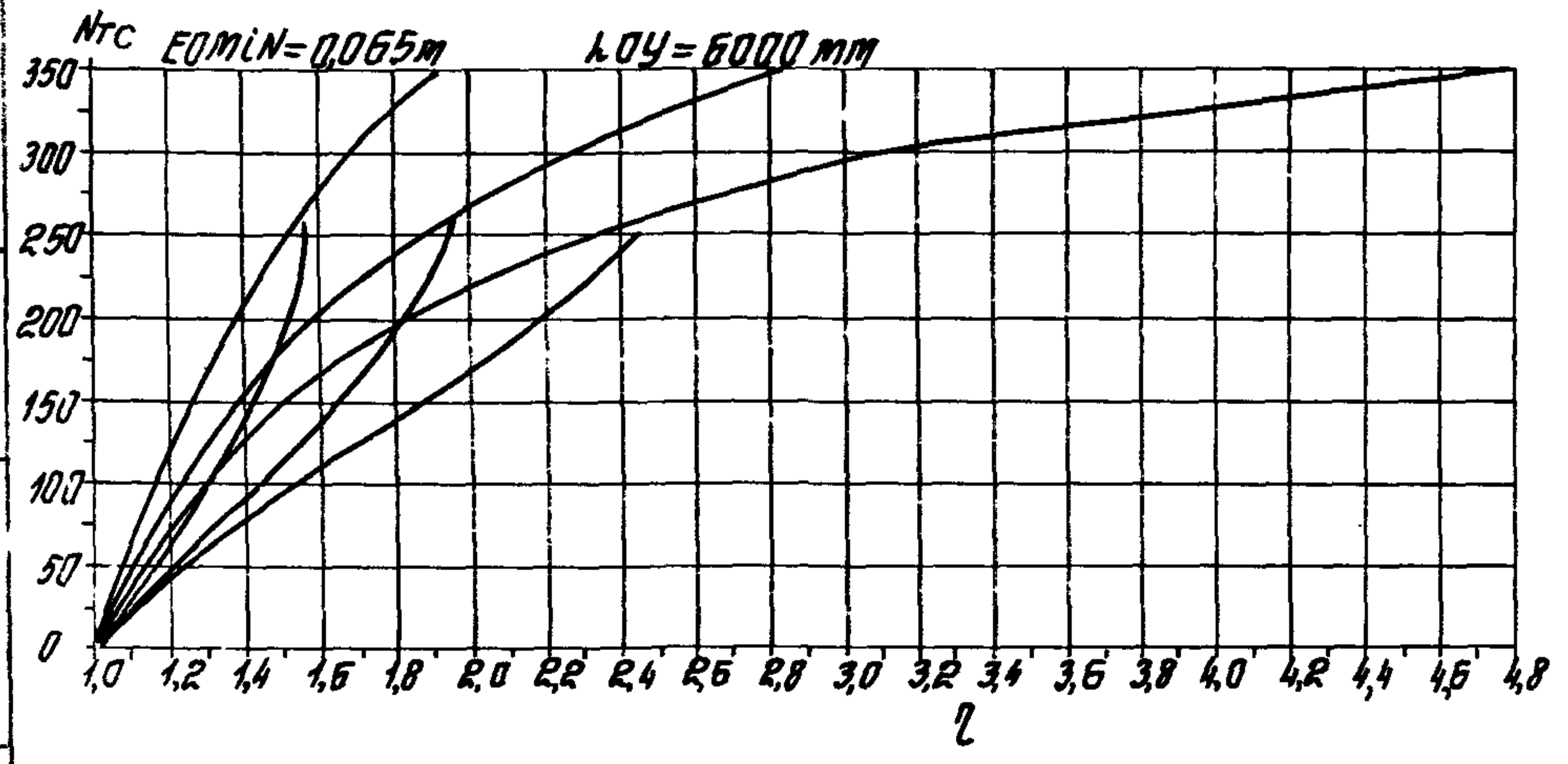
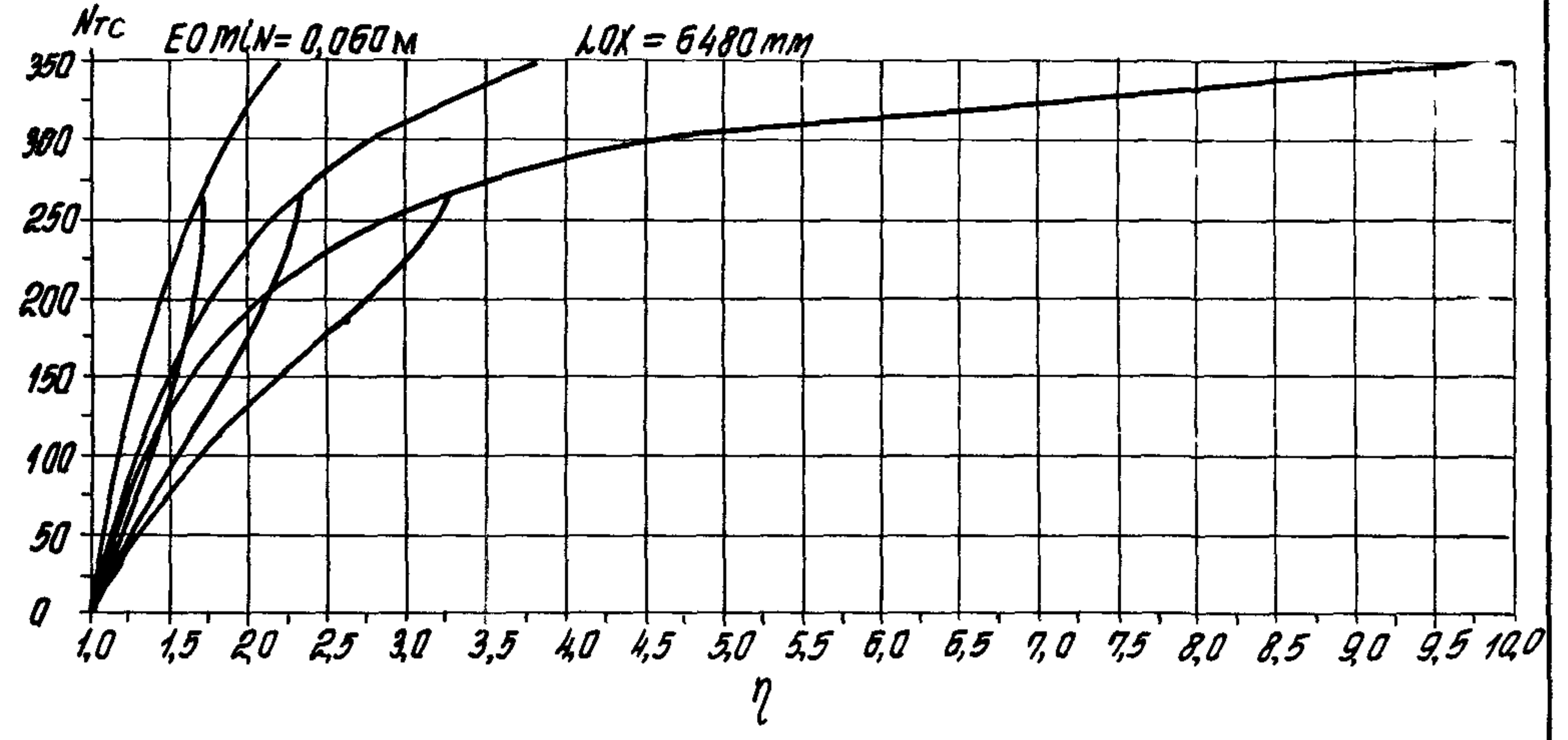
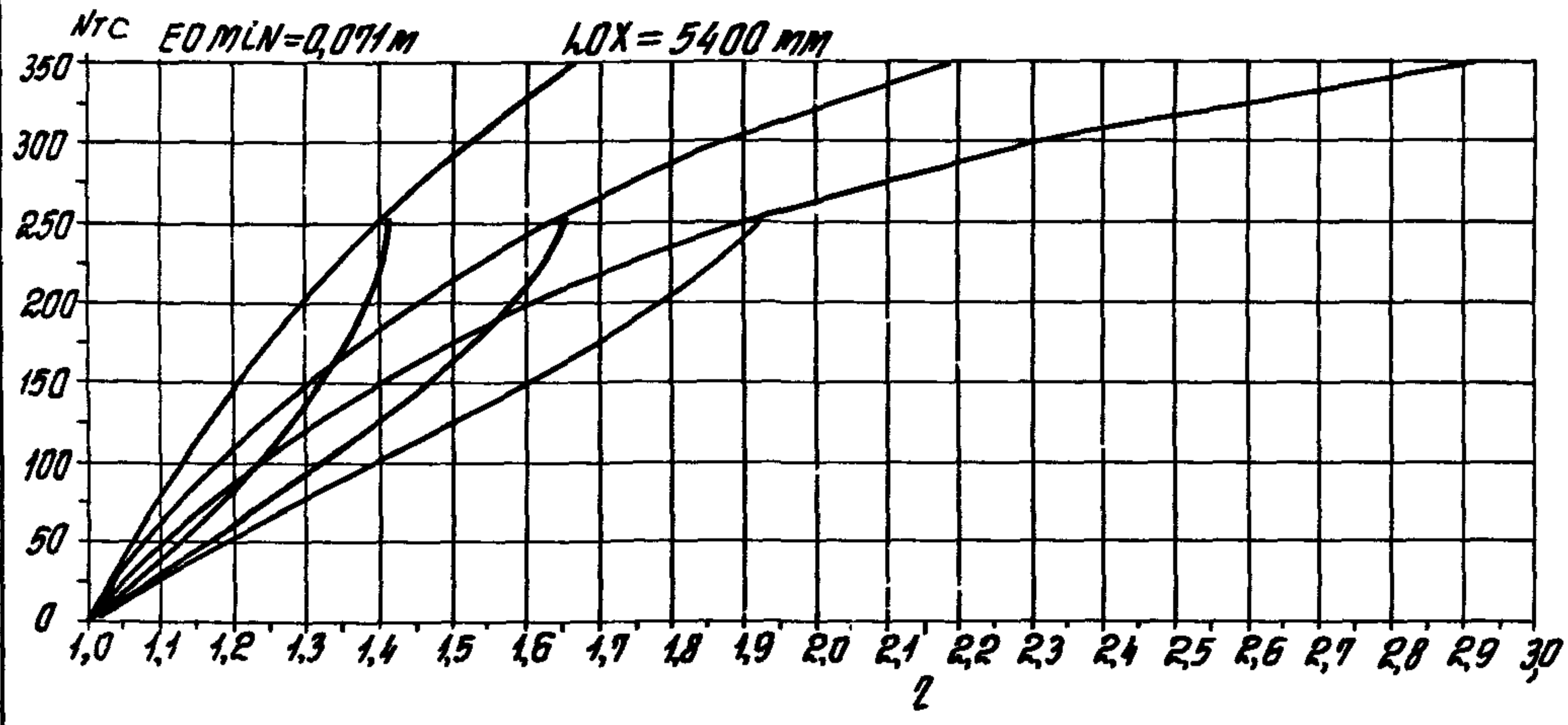

УЧБ № 11000 УУВУВУВ У УУВУВУВ УУВУВУВ

1.020.1-4	0-9 102	лсчм
		108

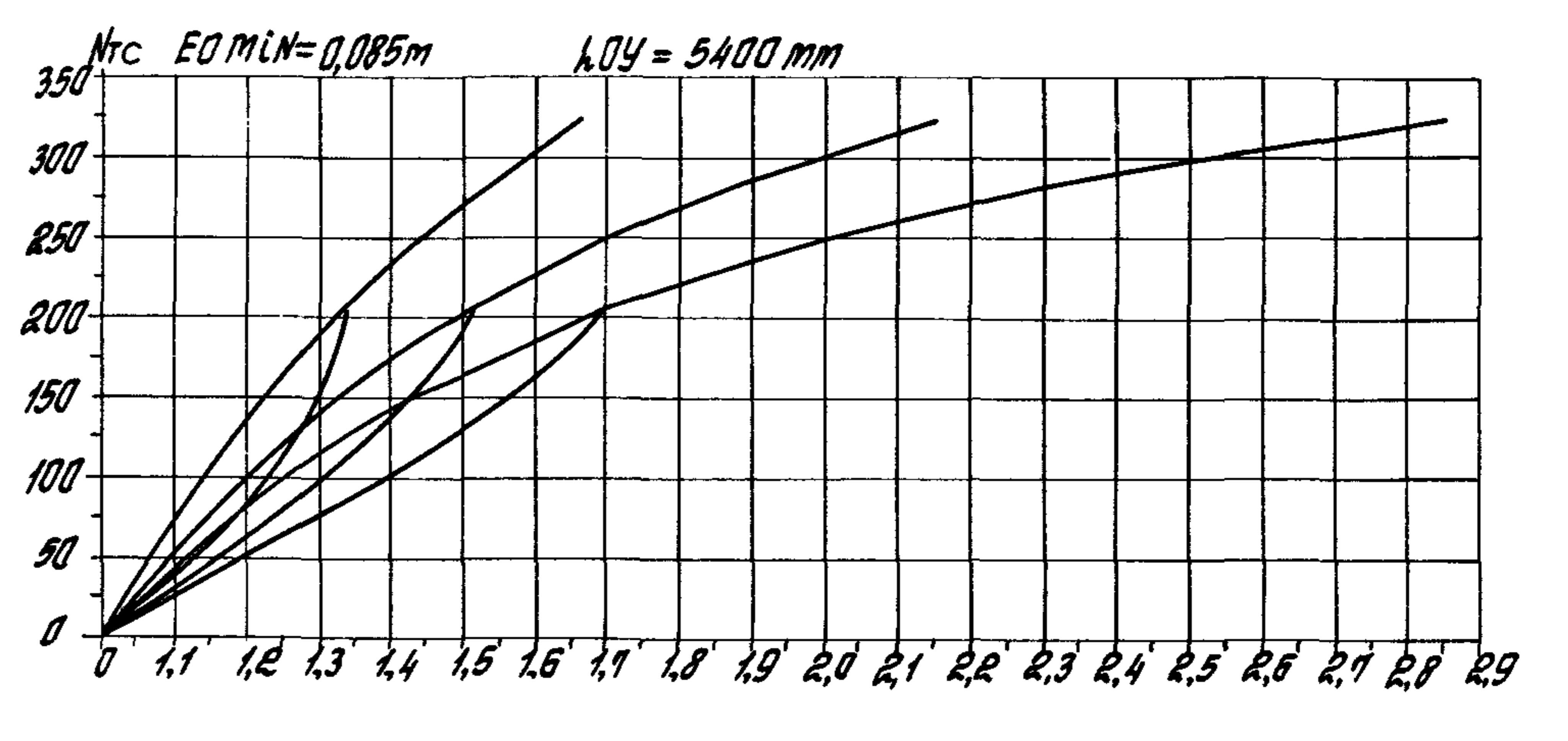
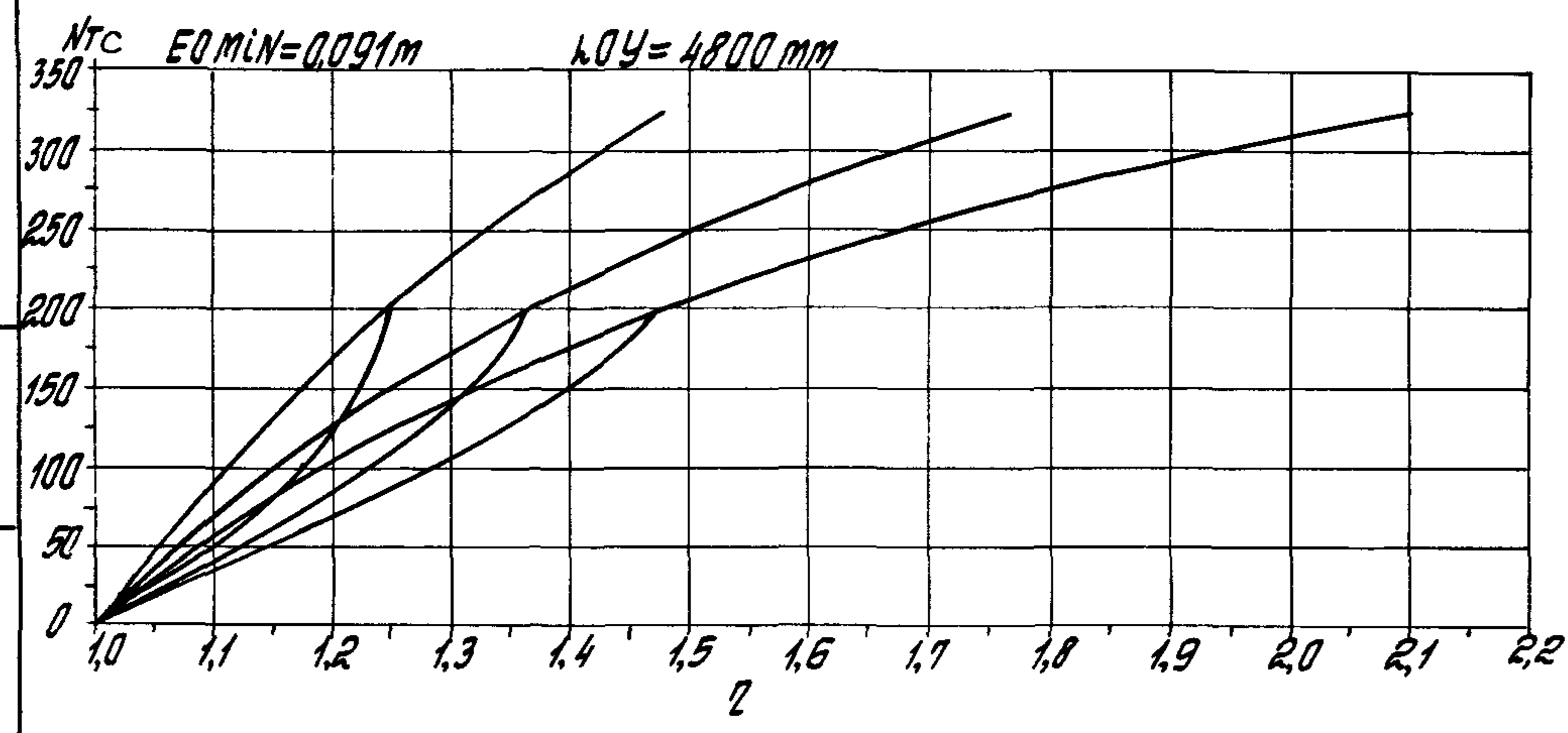
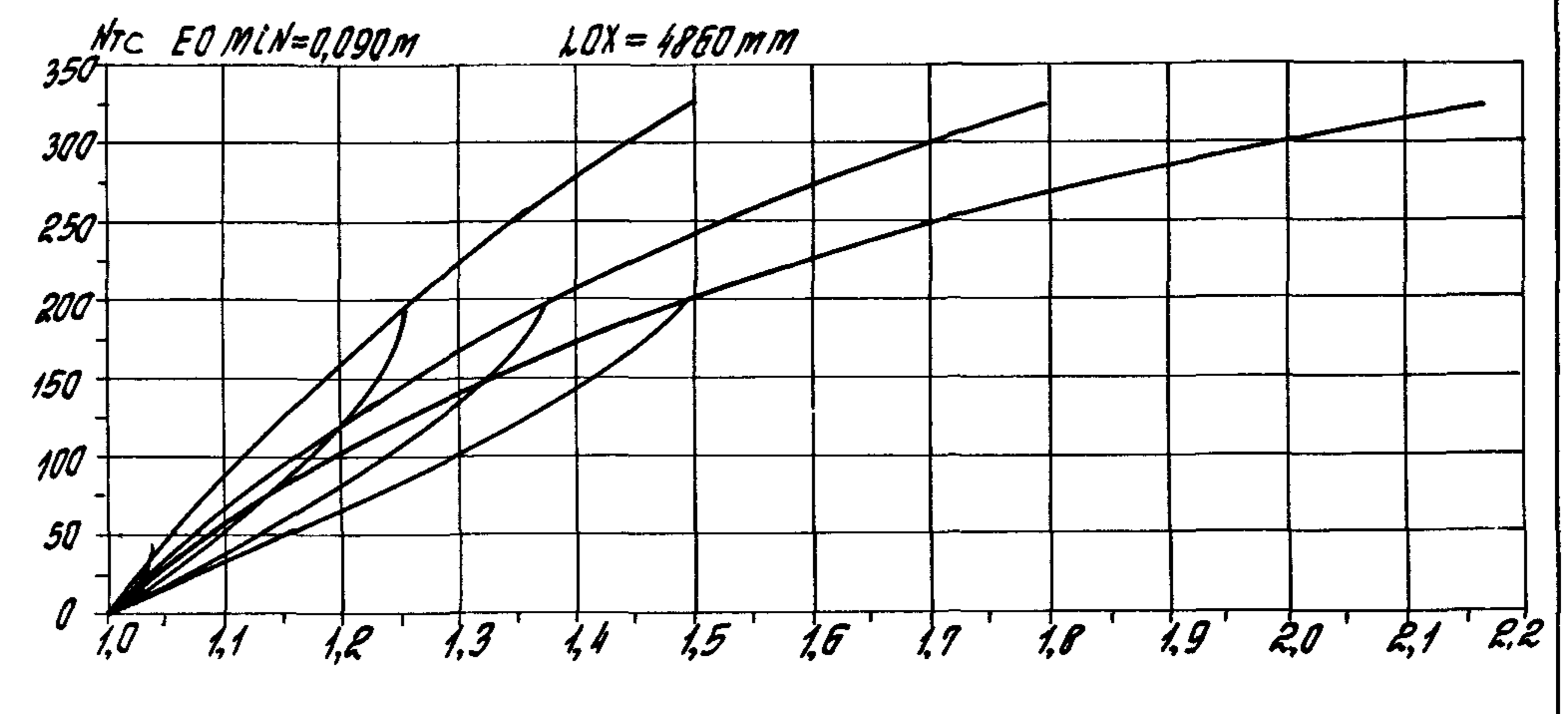
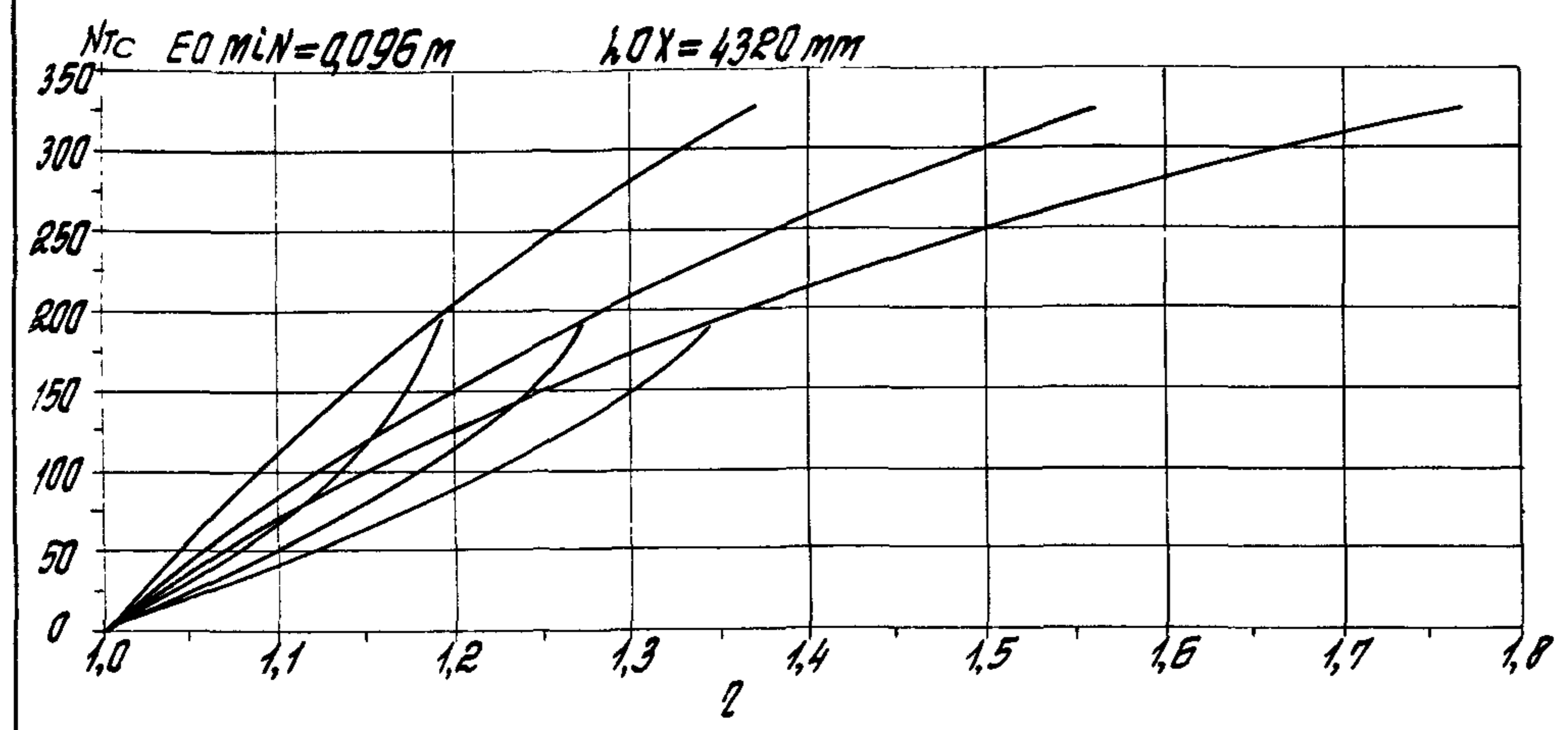

1/100 № 10000

1.020.1-4 0-9 002

Лист
117

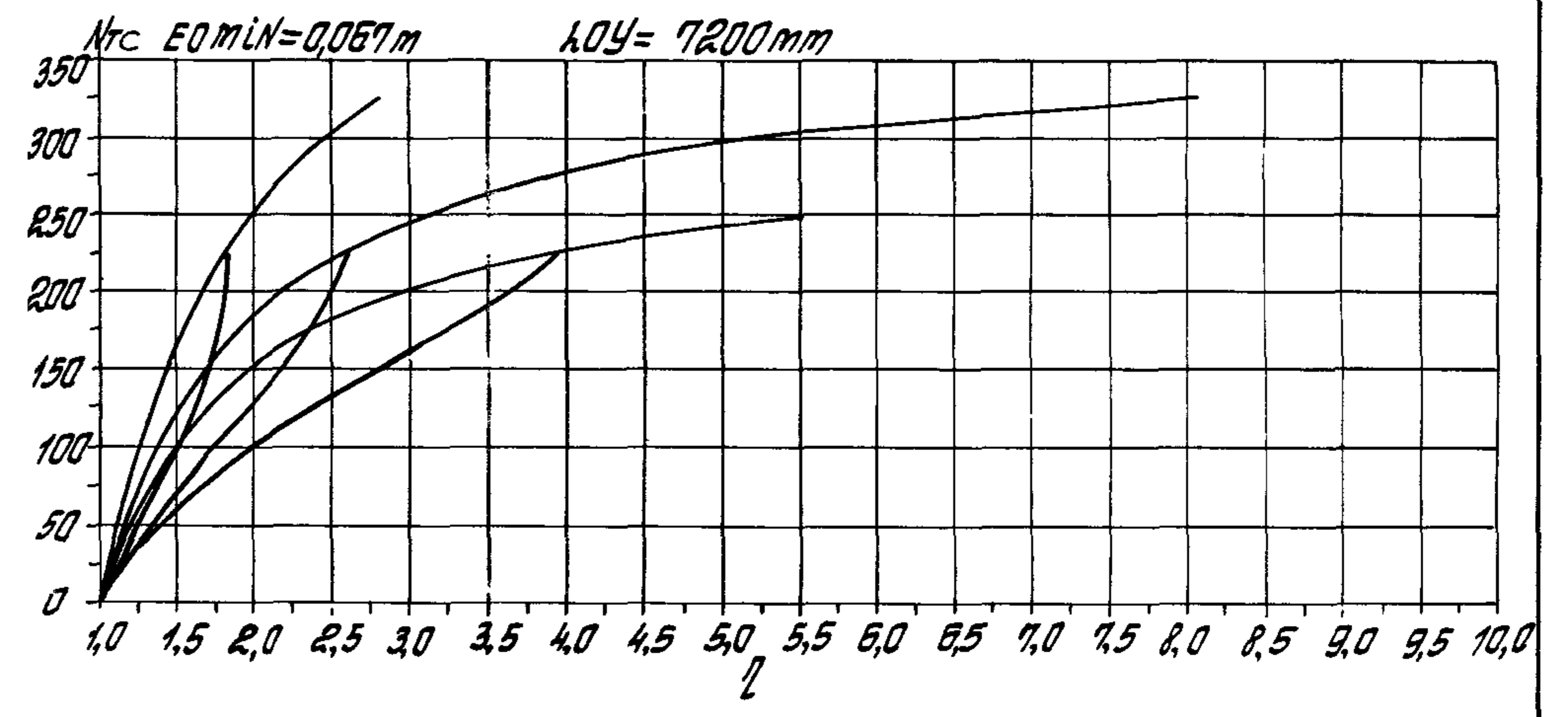
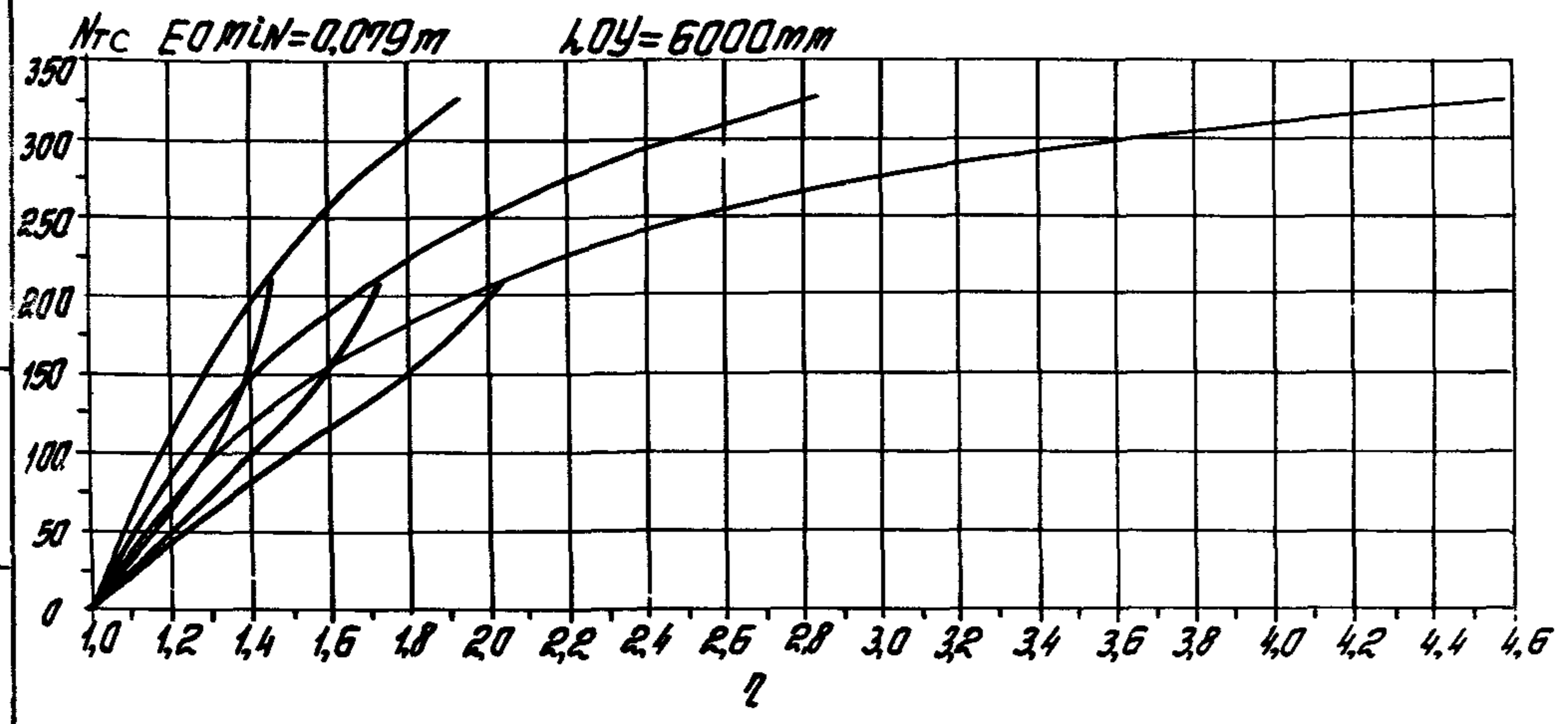
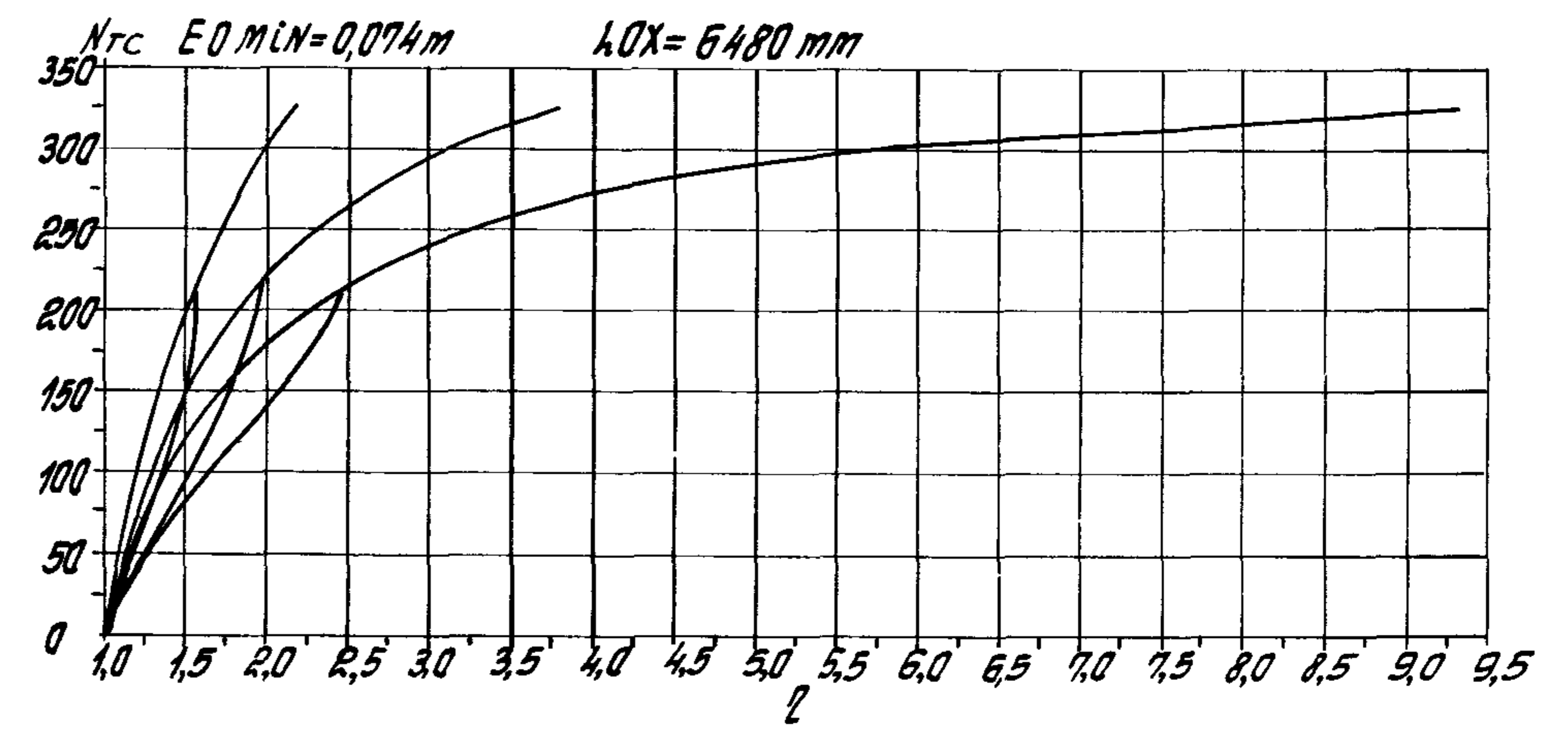
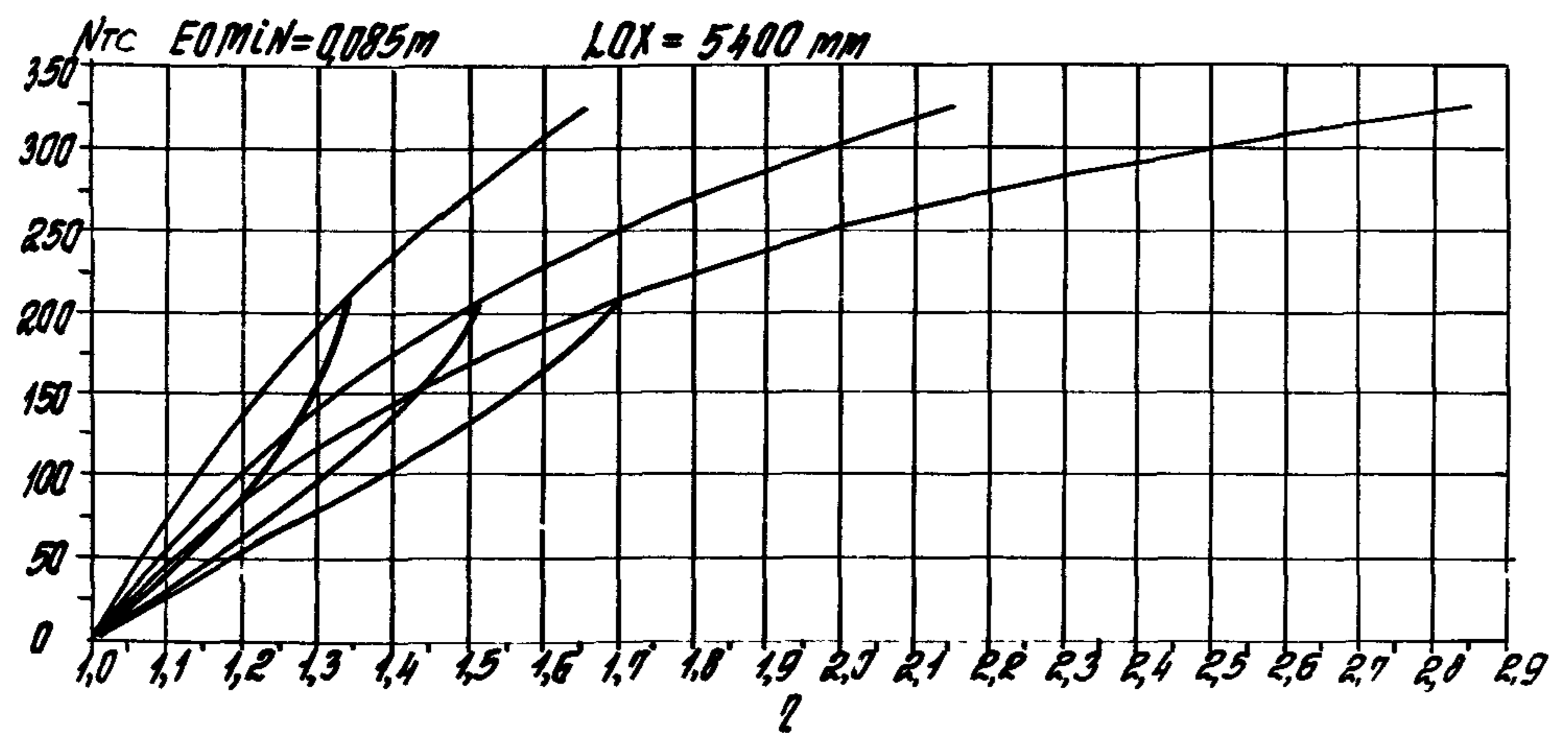

СІМ'Я ПІДПИСАНОГО ПІД ПІСЬМ'ЯМ

1.020.1-4 0-9 202	Лист 112
-------------------	-------------

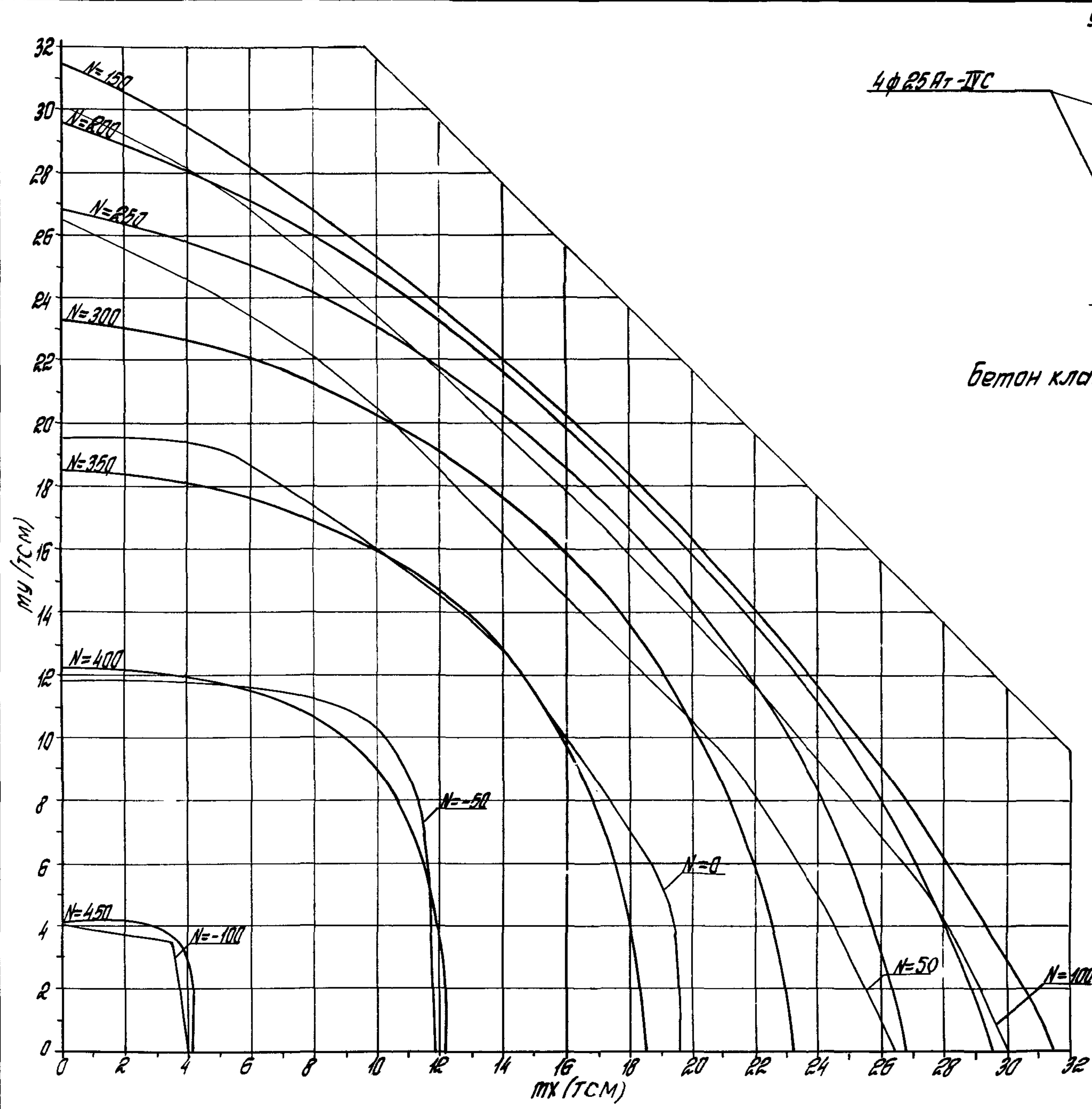

4φ 25 A_T-IVC

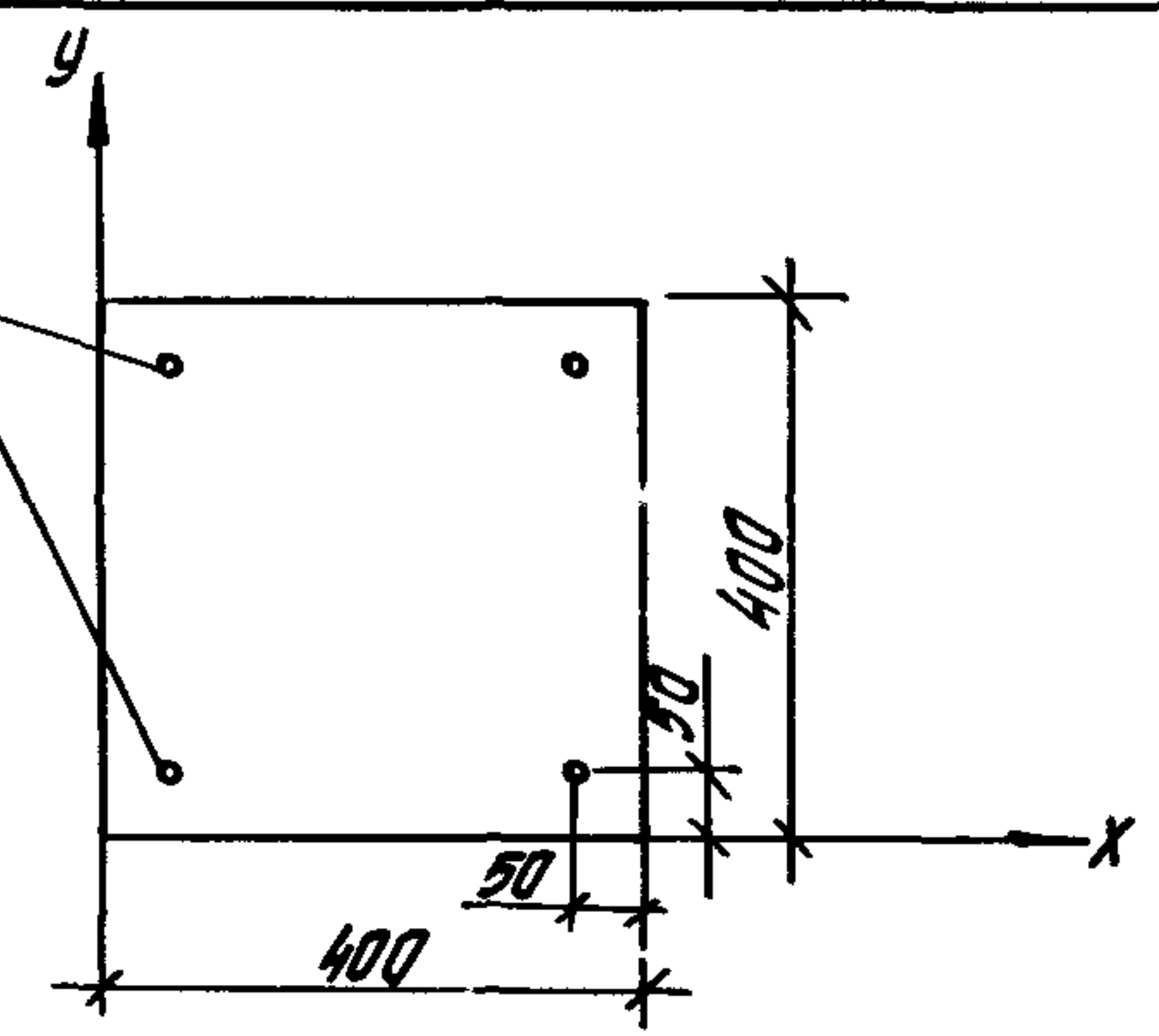

бетон класса В40,0 ($R_B = 24,2 \text{ МПа}$ при учете $\gamma_{B2} = 1,10$)
 сталь класса А_T-IVC
 код сечения - 115а

1.020.1-4 0-9 002
 113

1.020.1-4 0-9 002

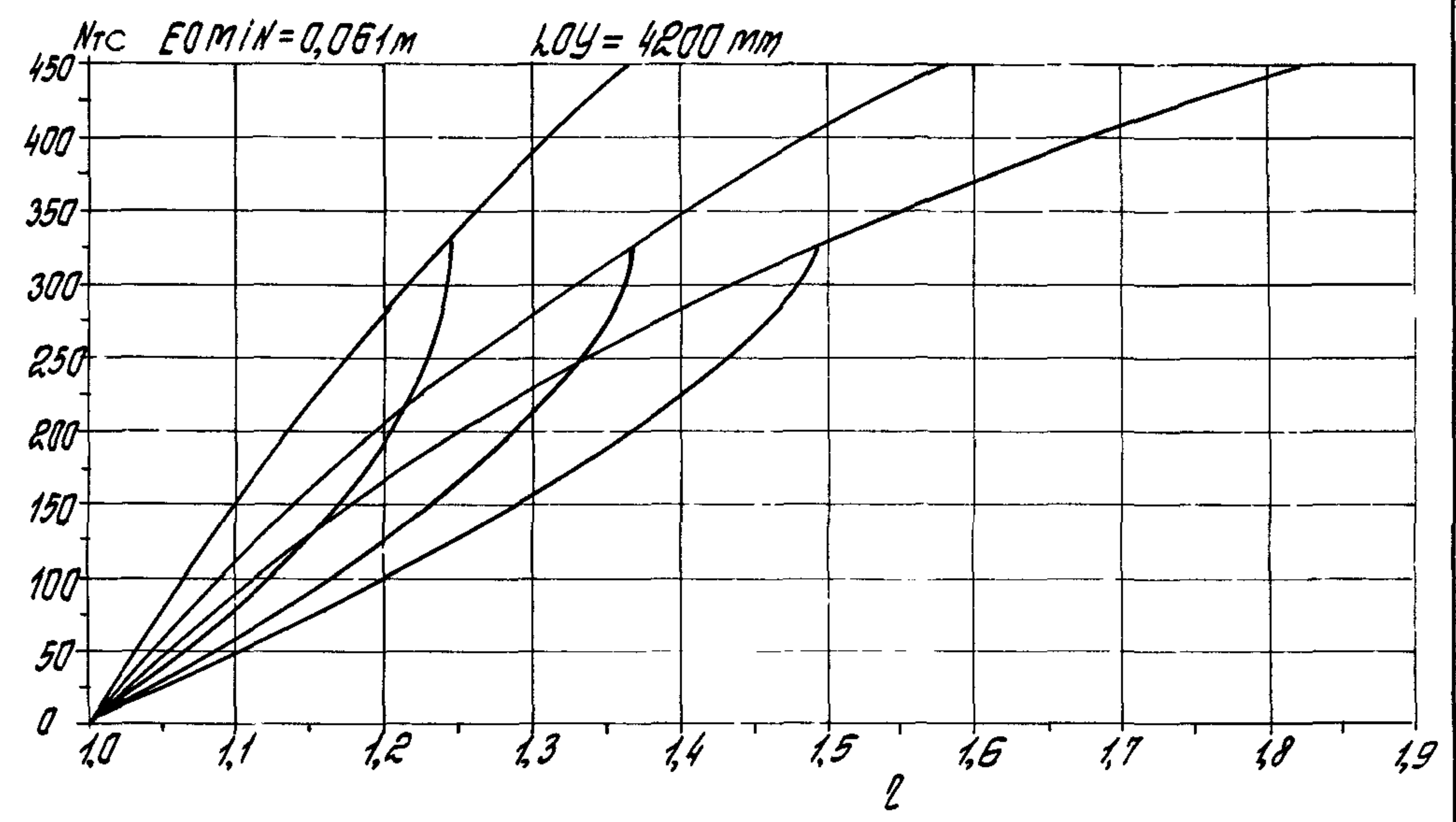
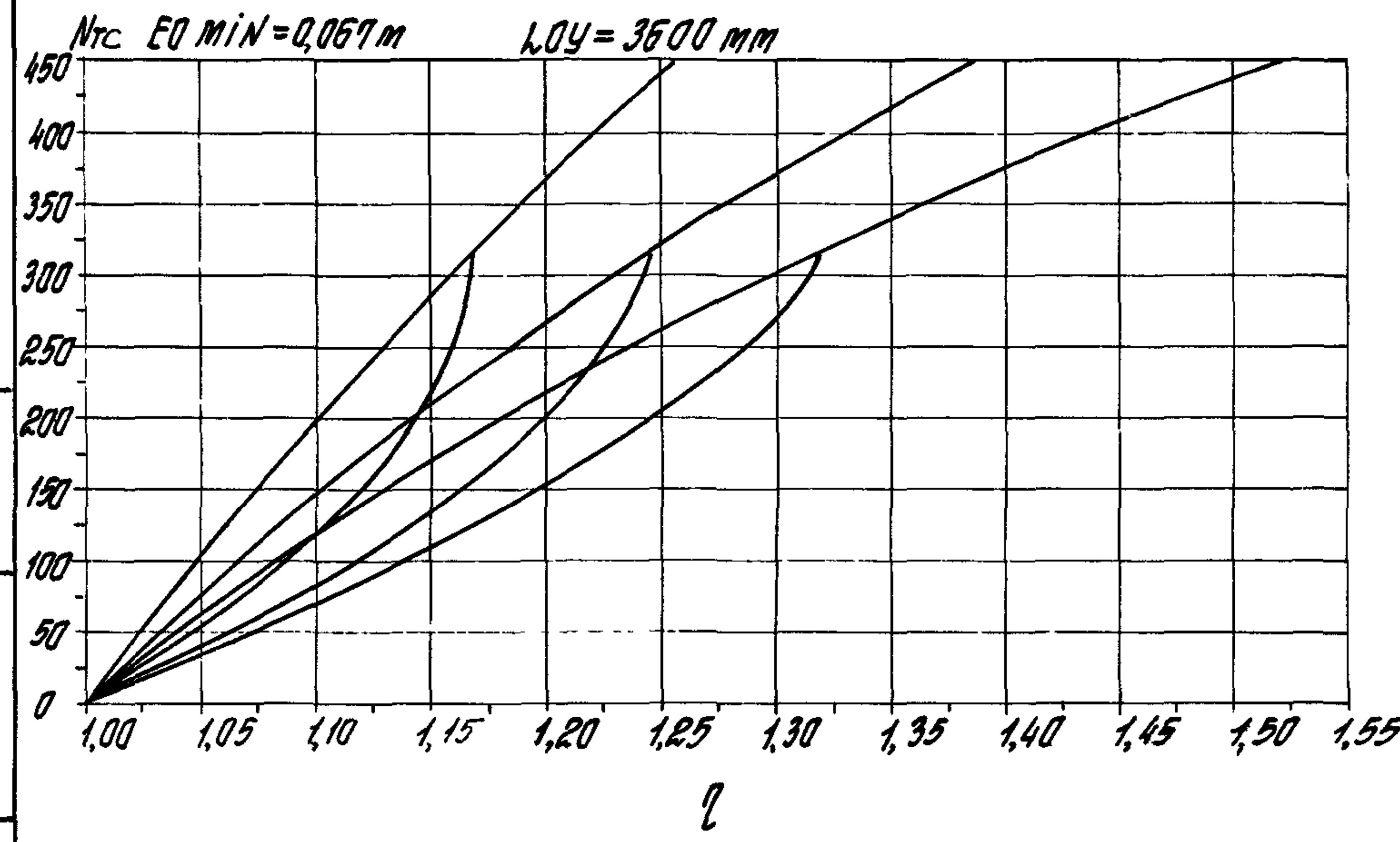
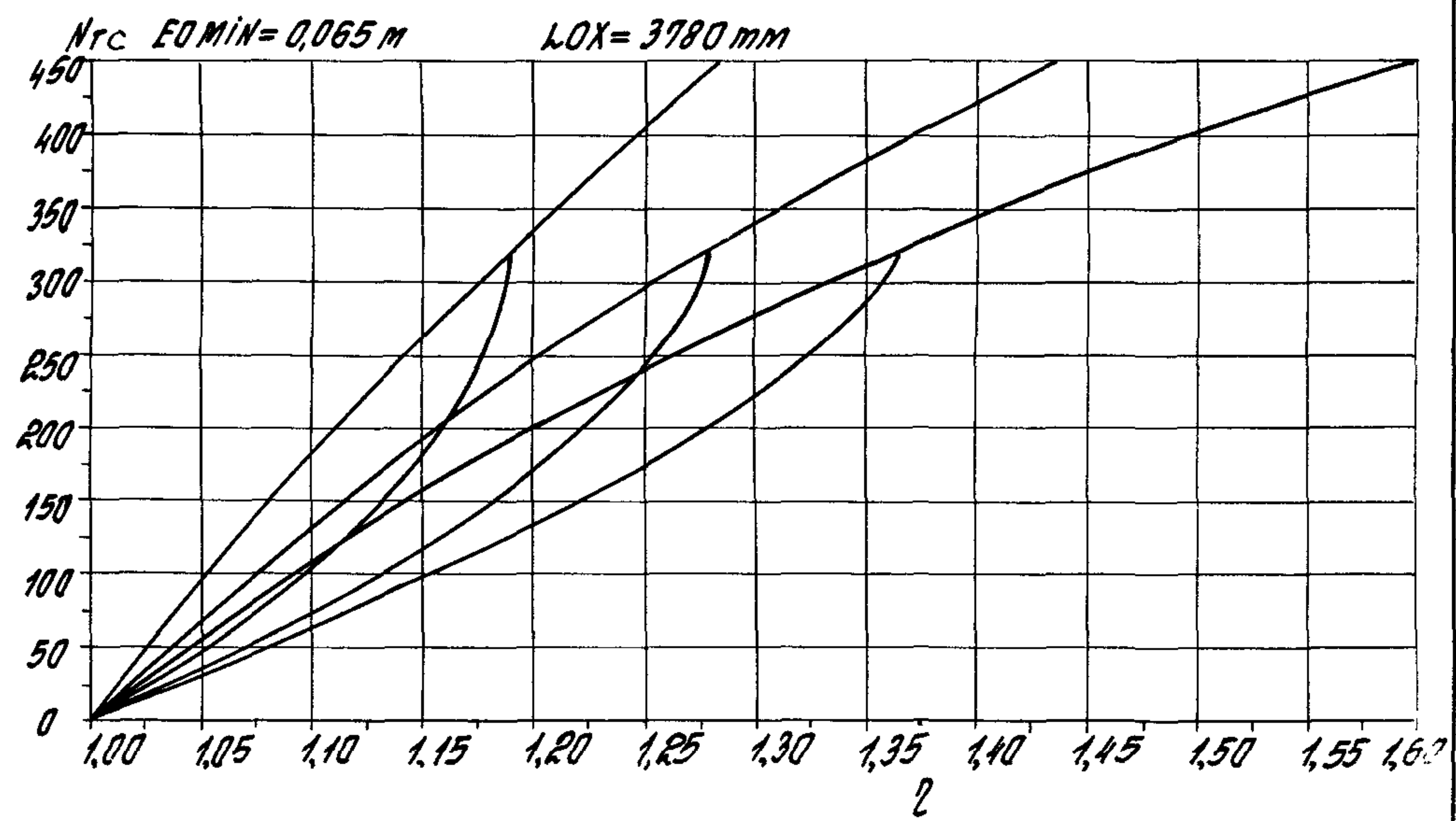
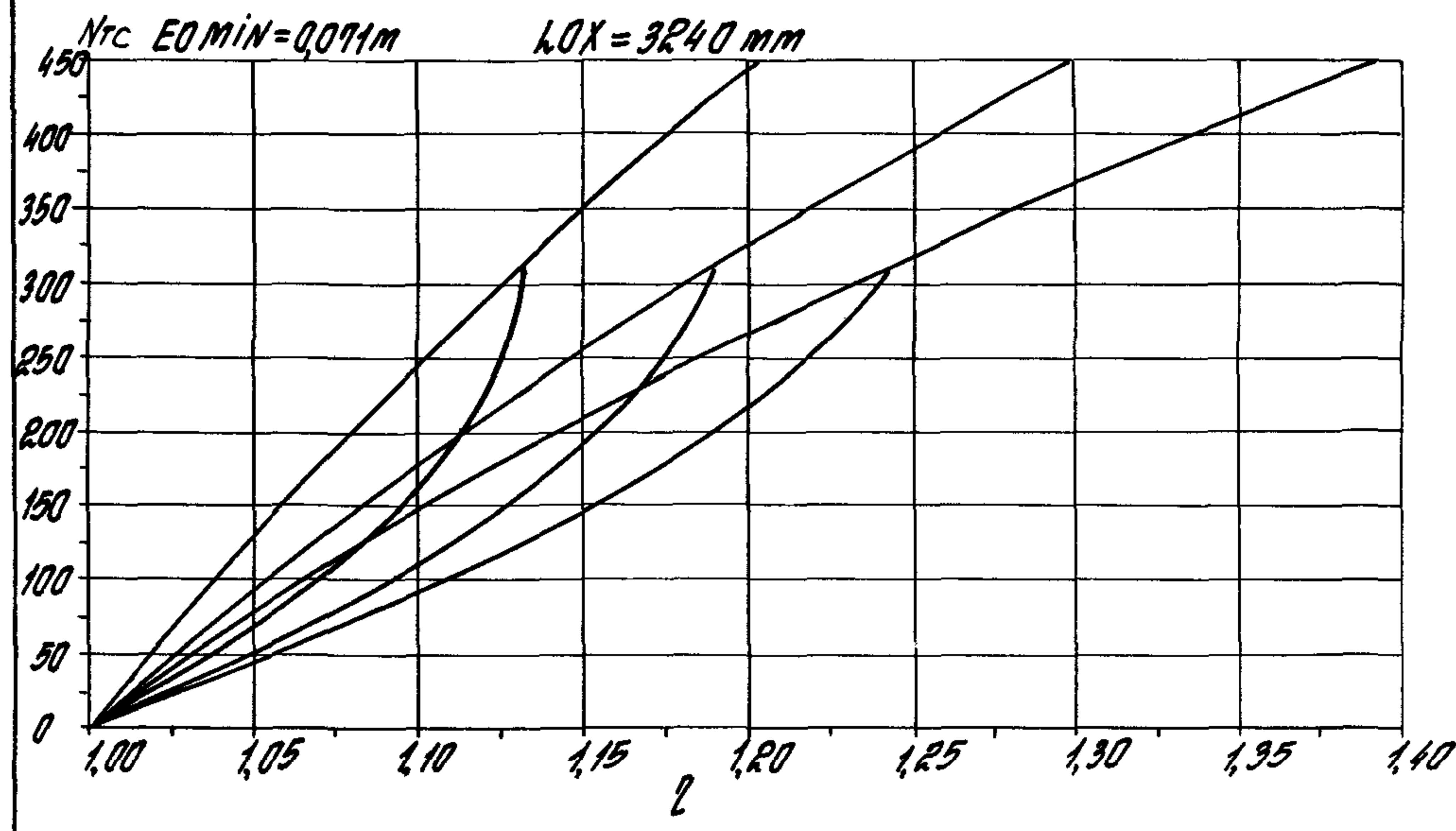

Инд. № п/п. Индекс и дата изготовления №

1.020.1-4 0-9 002 лист 114

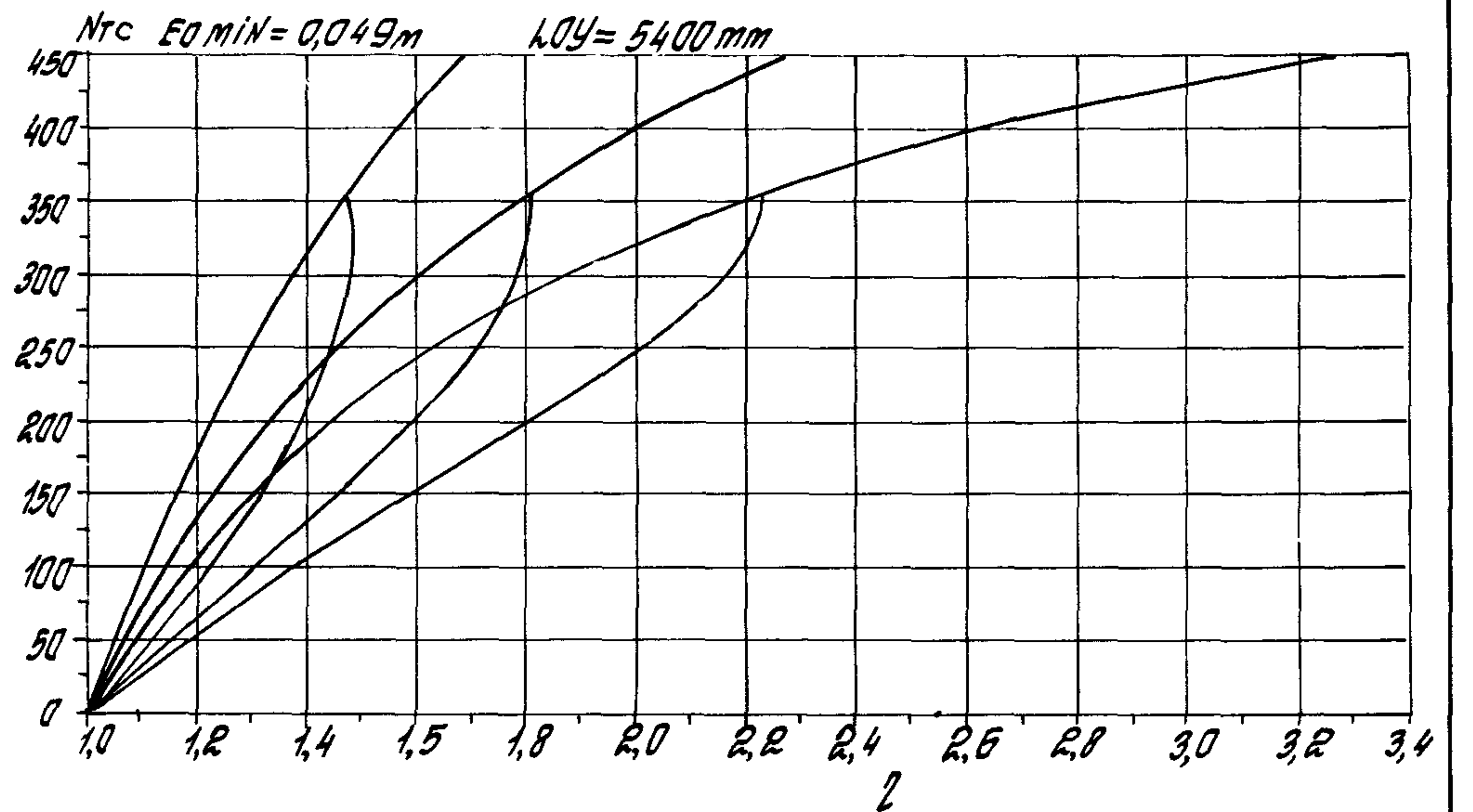
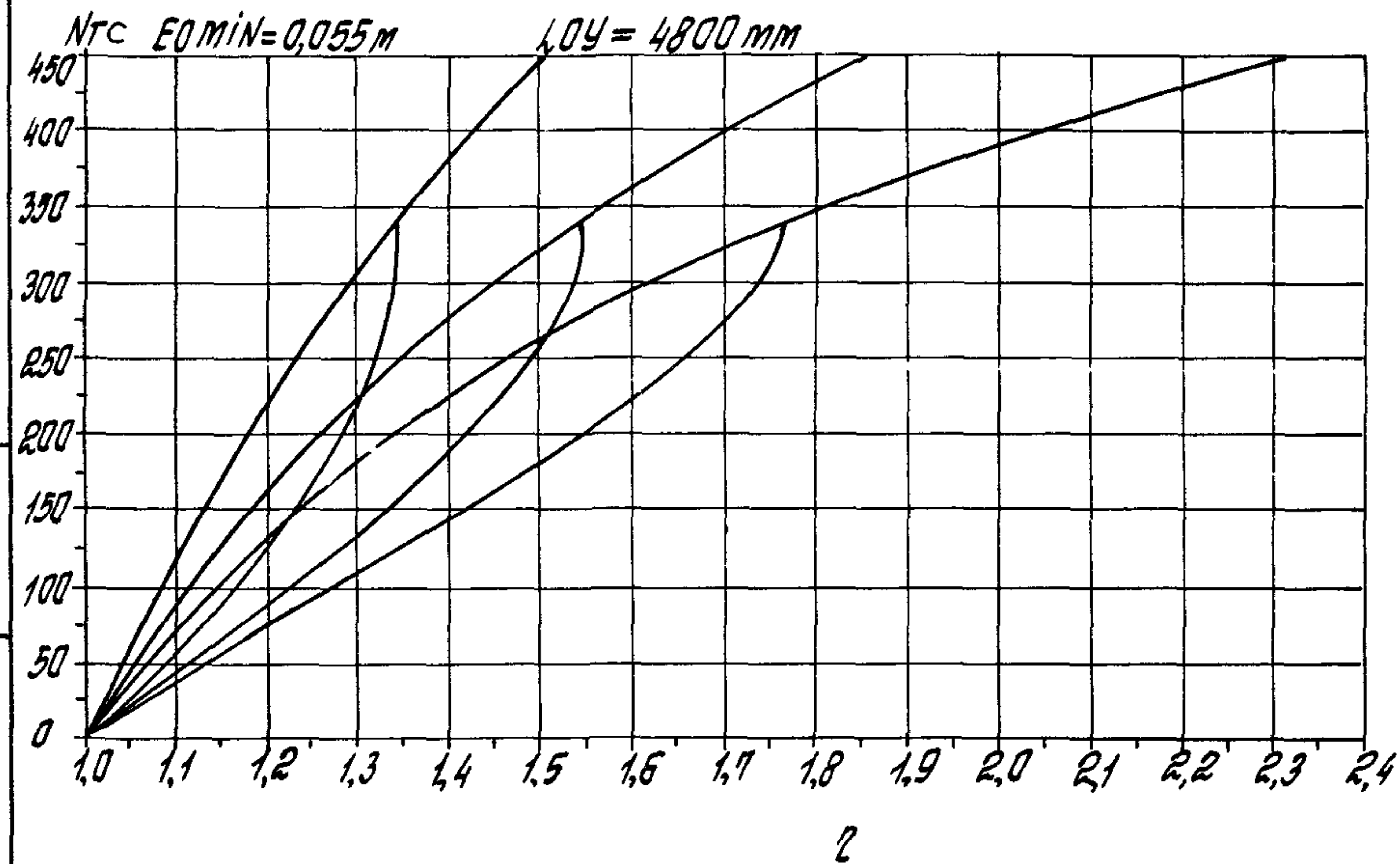
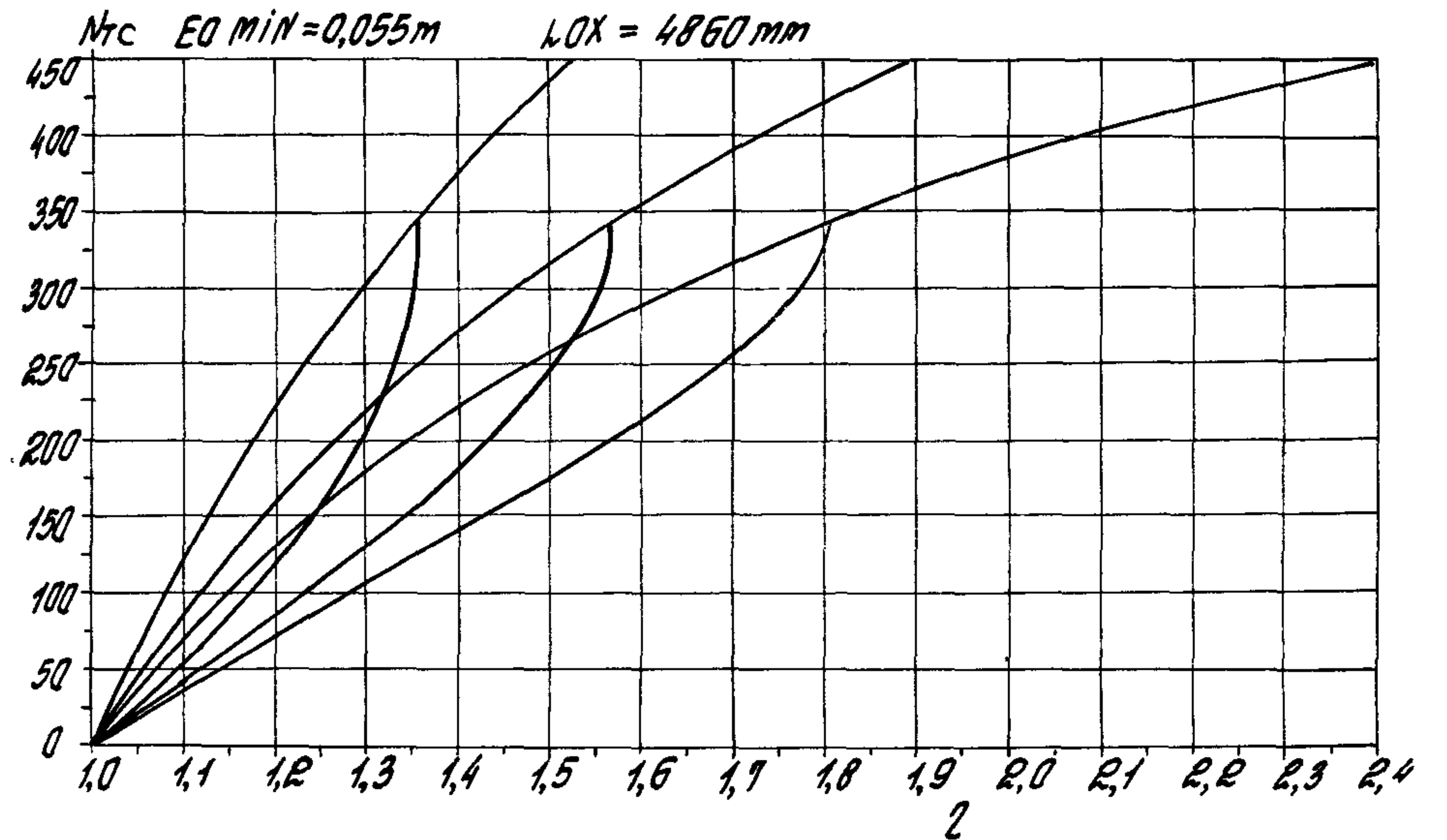
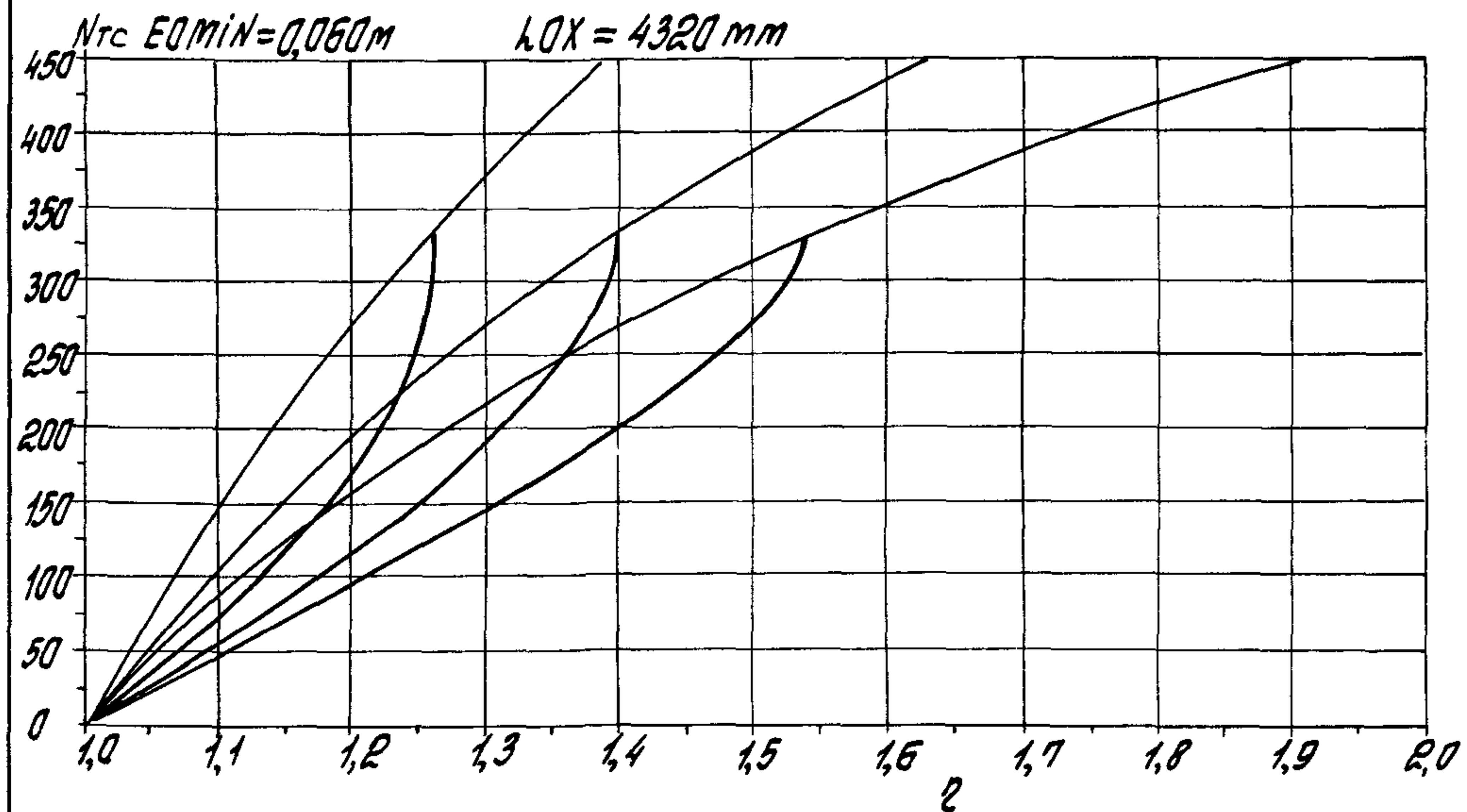

УИВ № 1000. Инженер и техник. 193000 УИВ № 1000.

1.020.1-4 0-9 002 Лист 115

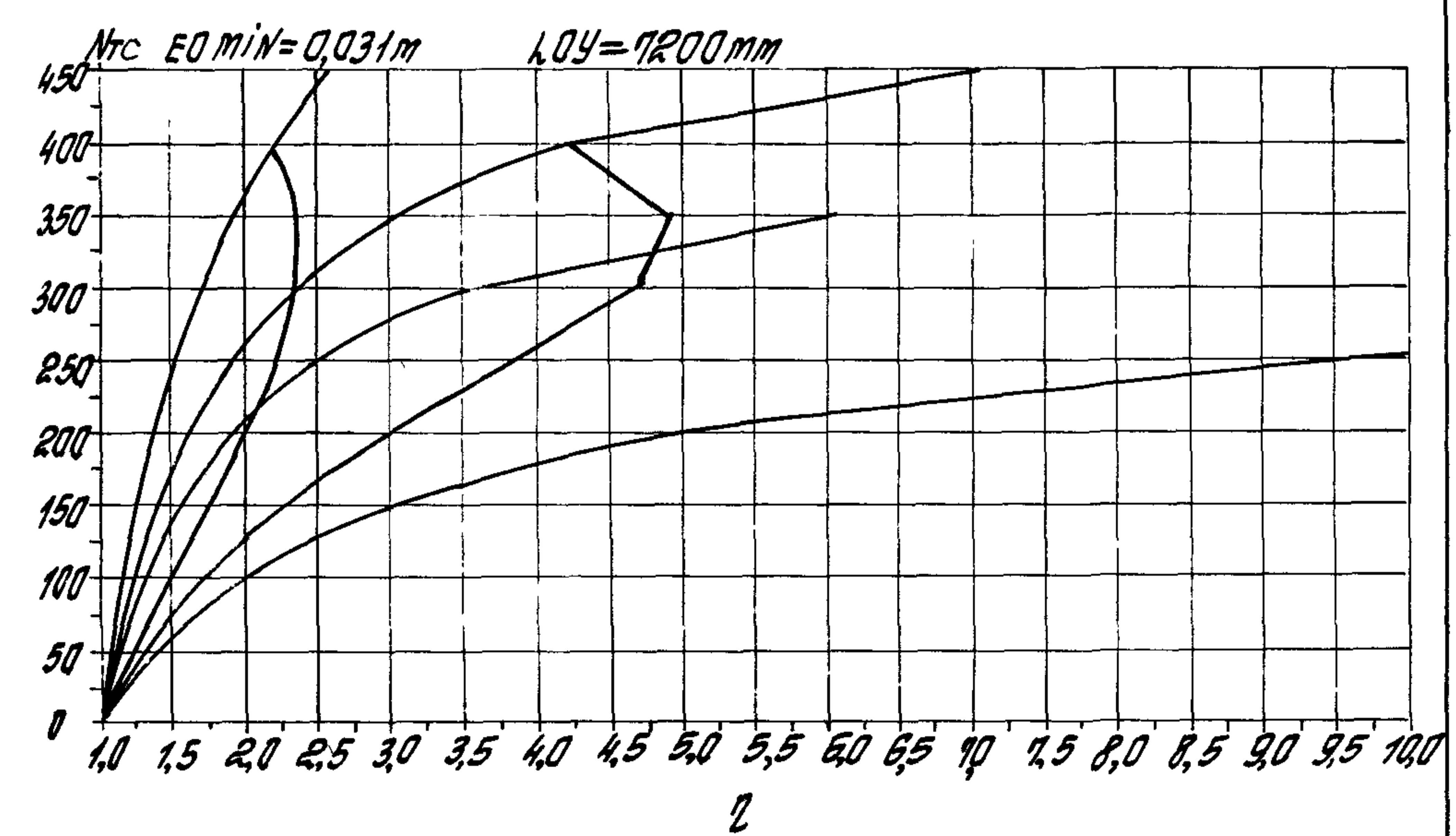
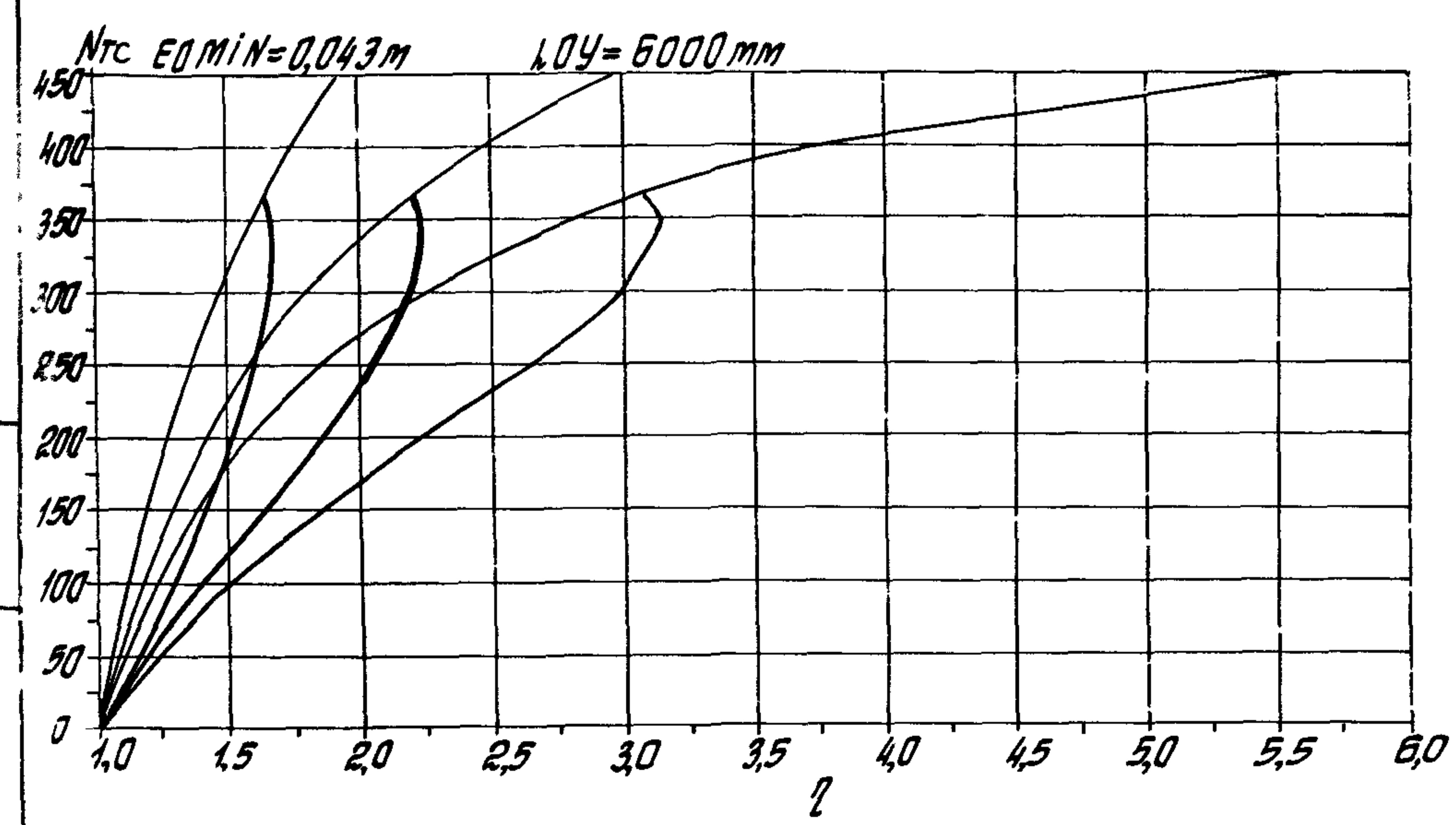
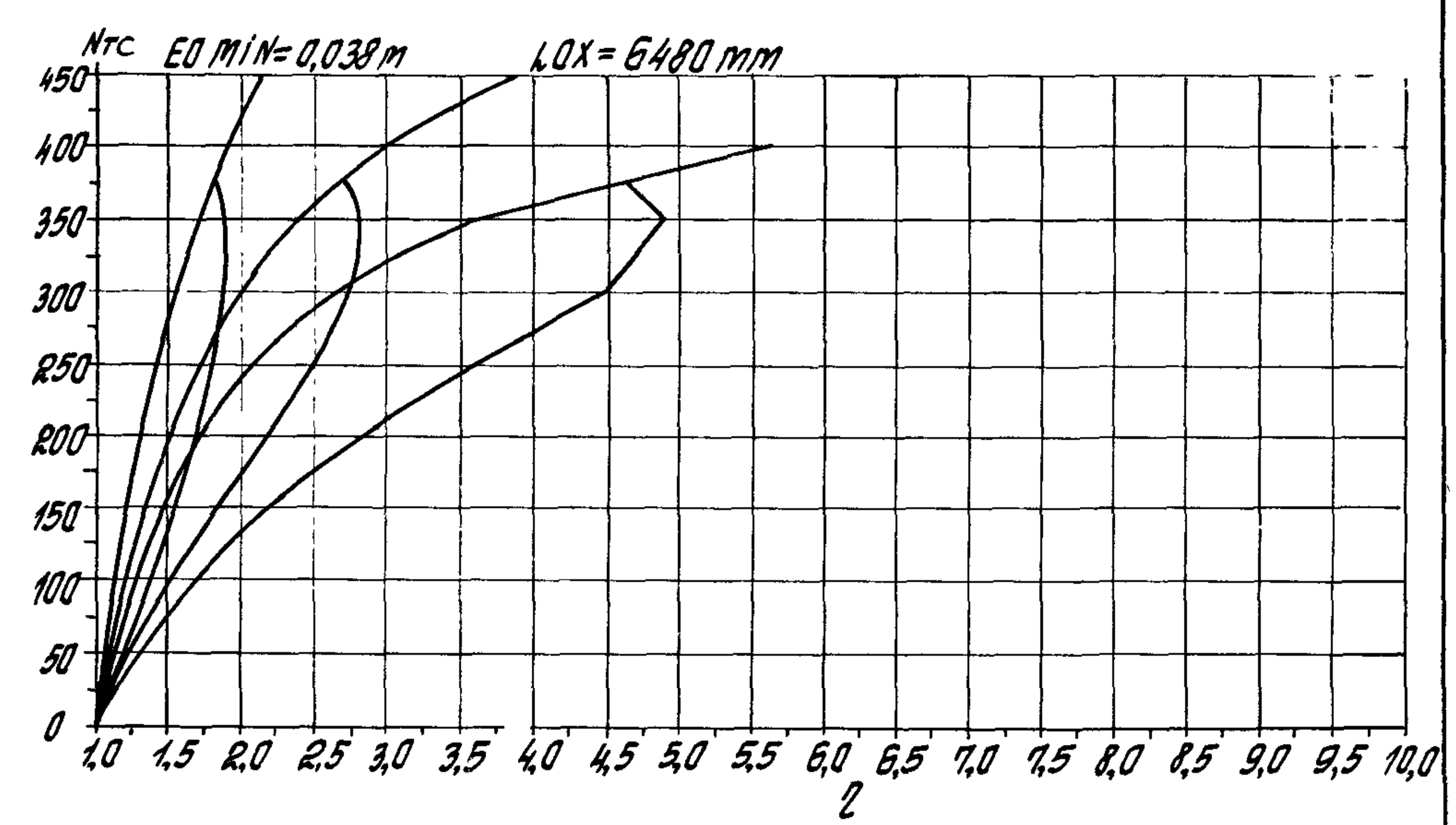
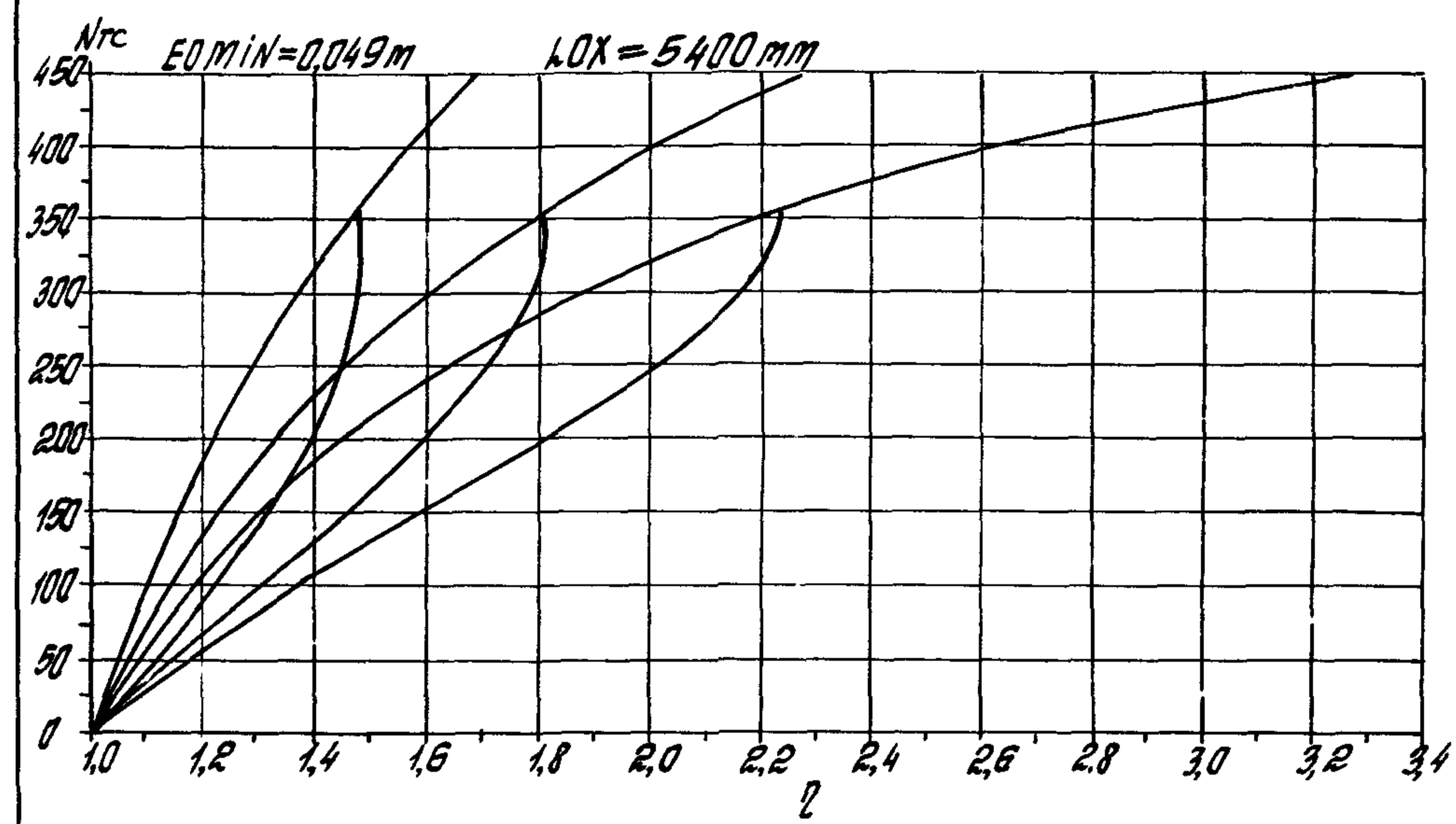

УИД № 10000. УИДНОБА У ОДММ В.С.С.С.С. УИД. №

4φ25 AТ-IV c

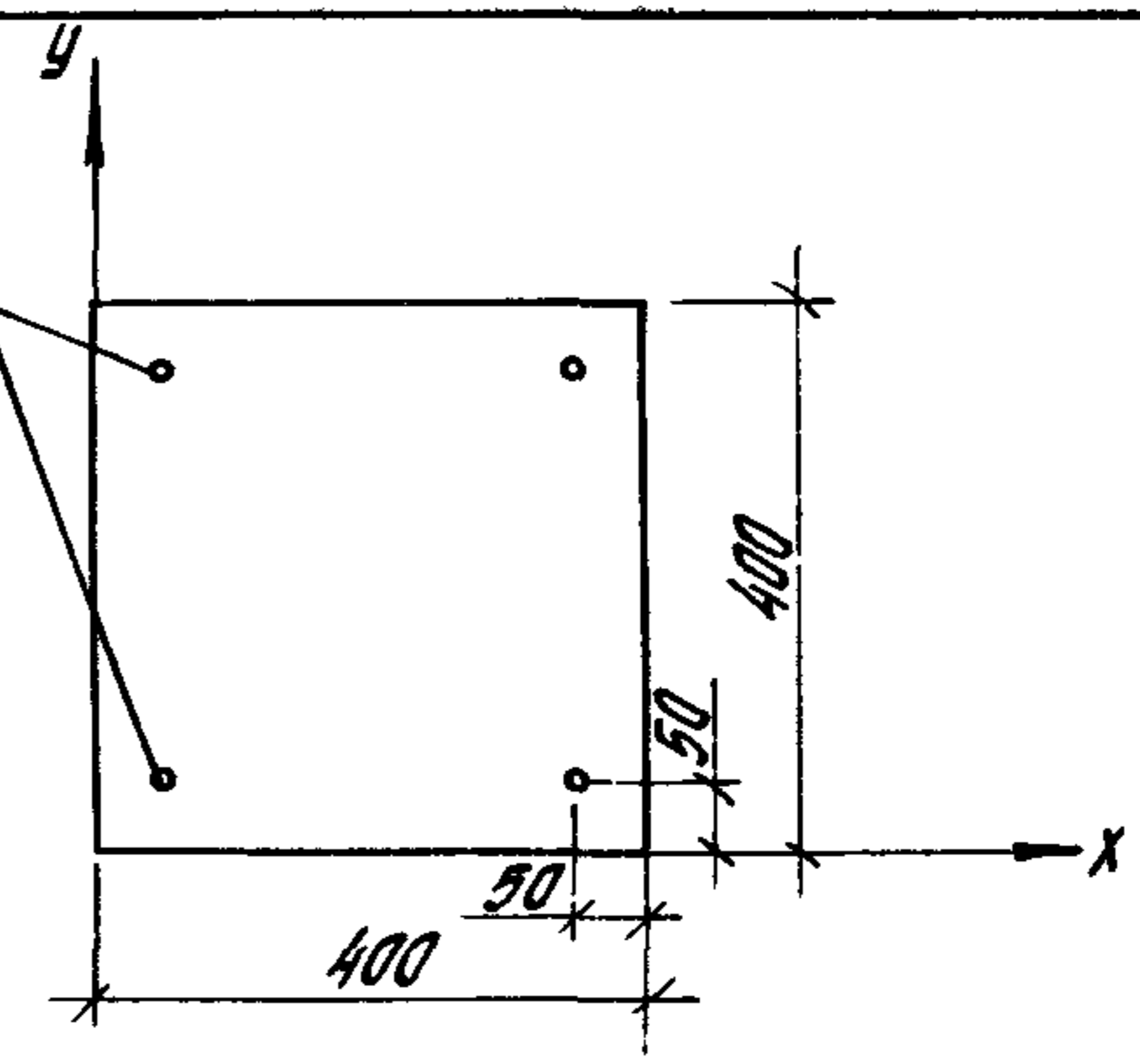

Класс бетона В40,0 ($R_b = 19,8$ МПа при учете $\gamma_{B2} = 0,90$)
 Сталь класса АТ-IV c
 Код сечения - 1158

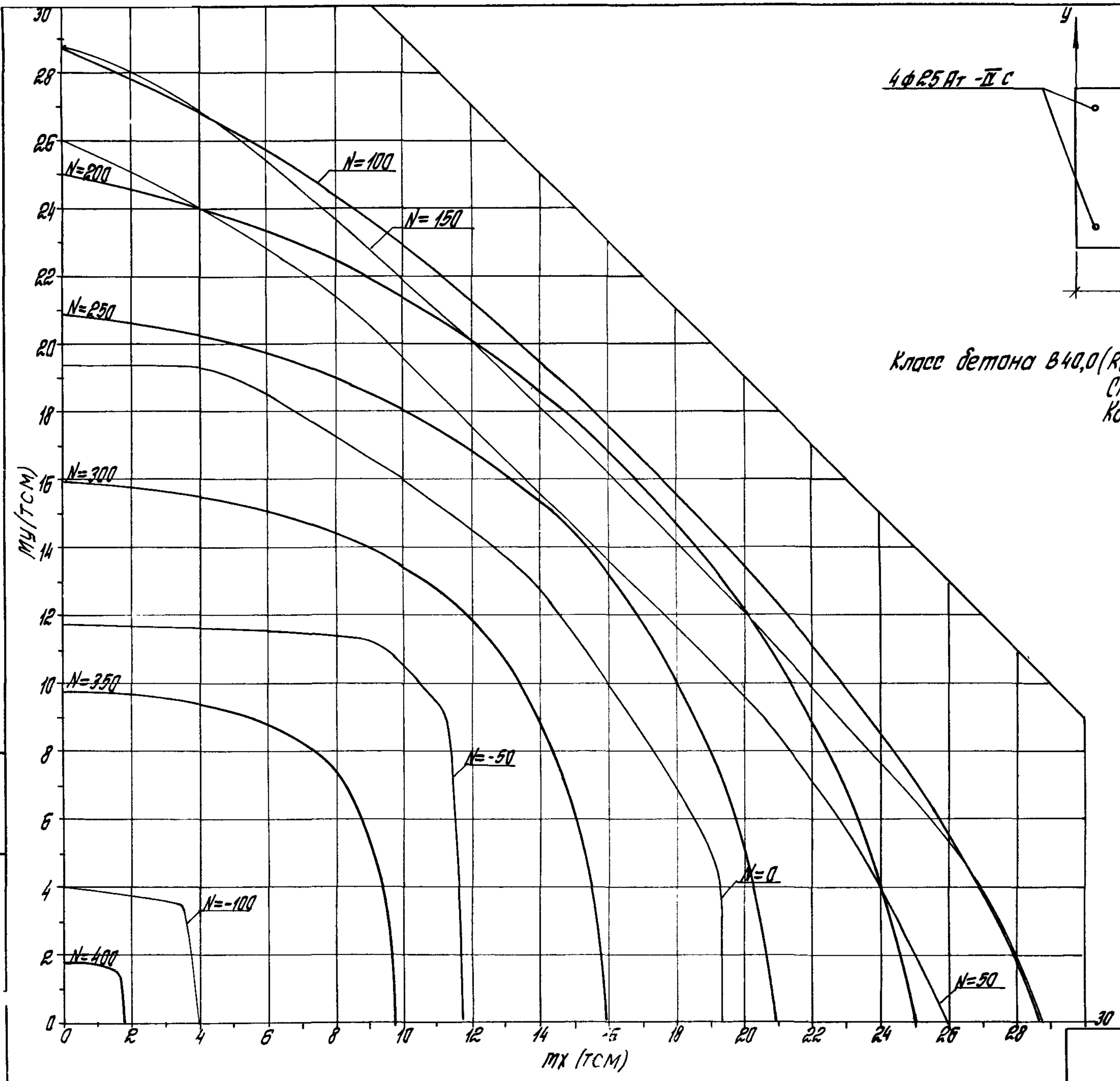

Проектная организация ООО "Спецпроект"

1.020.1-4-0-9 002

Лист	117
------	-----

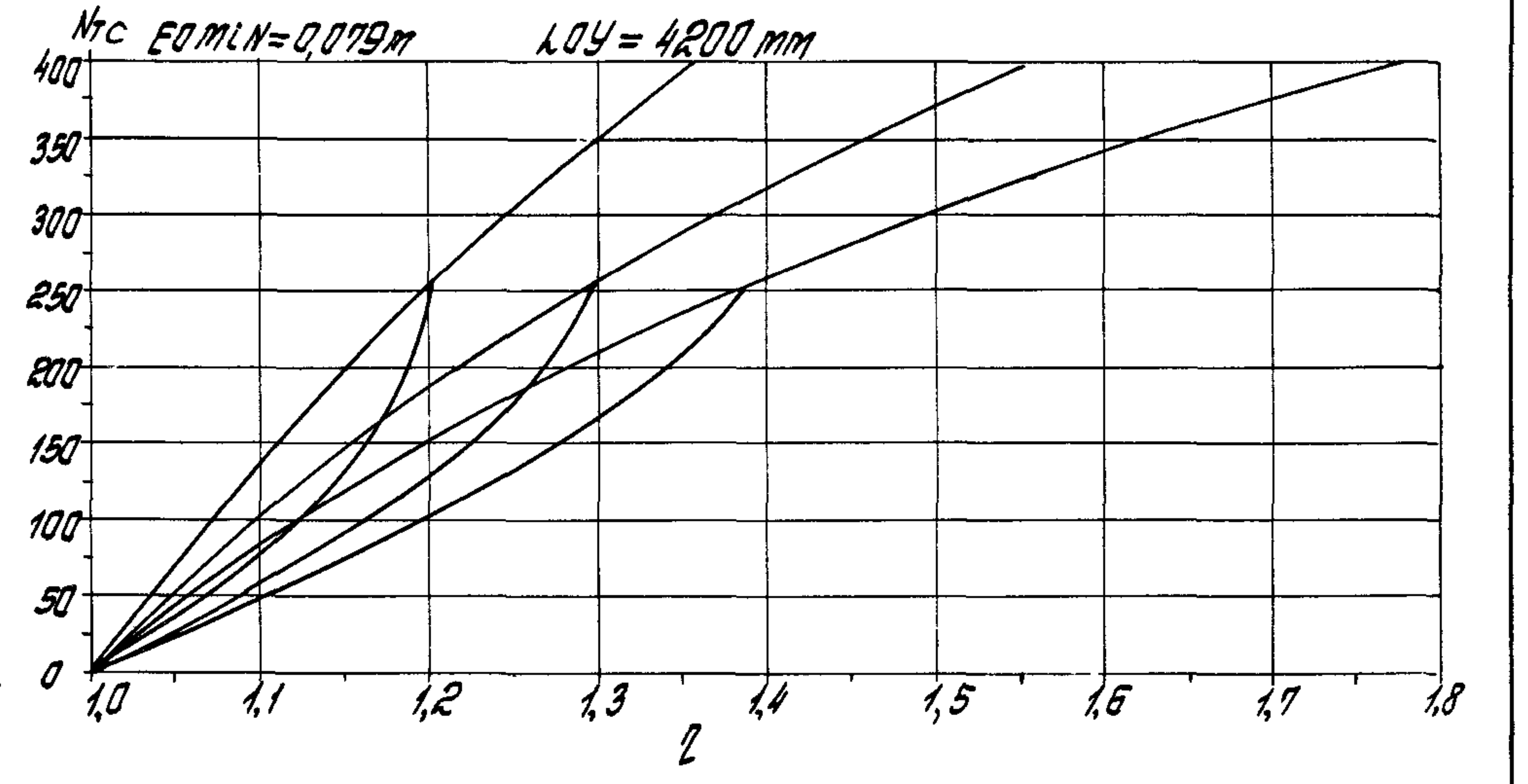
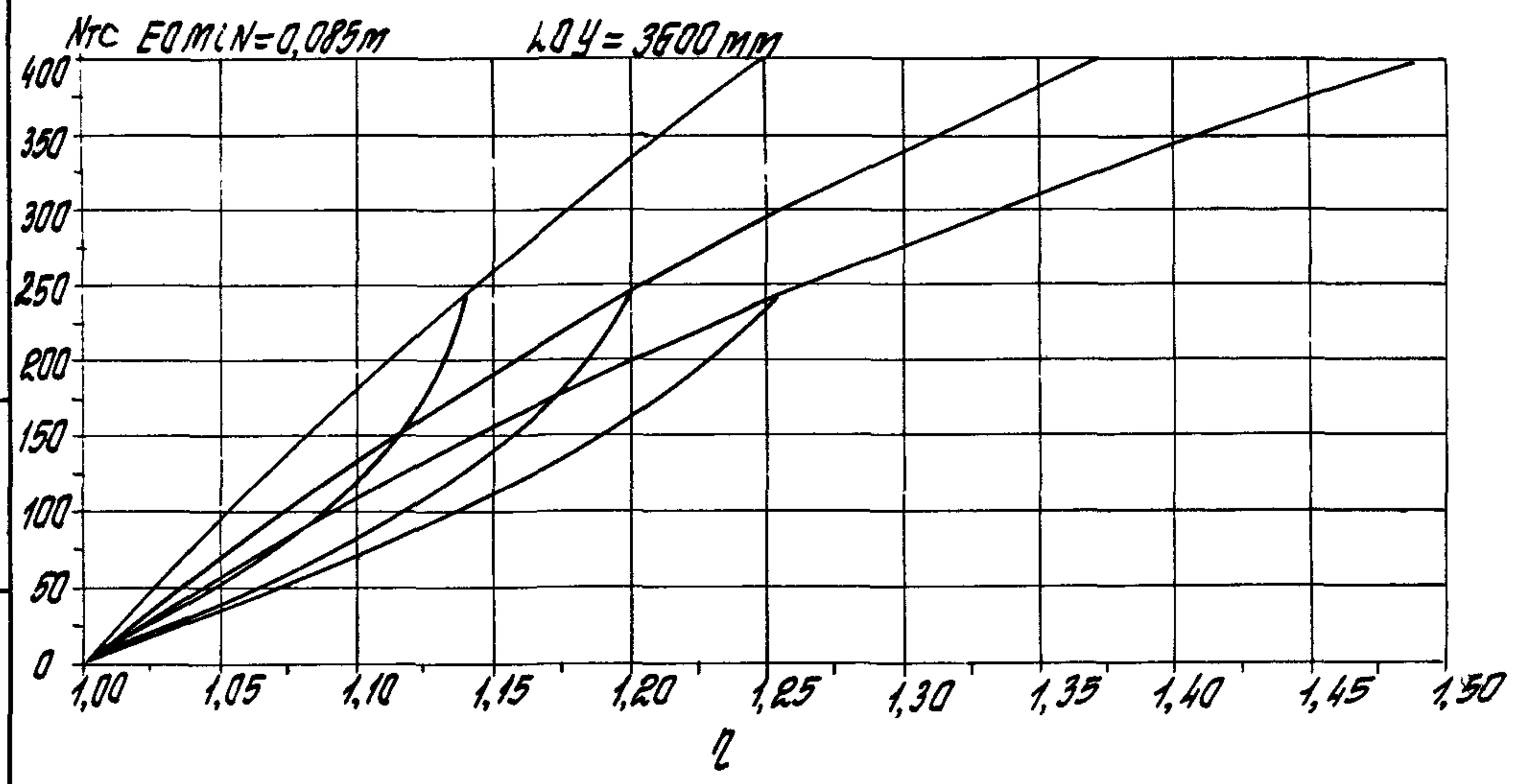
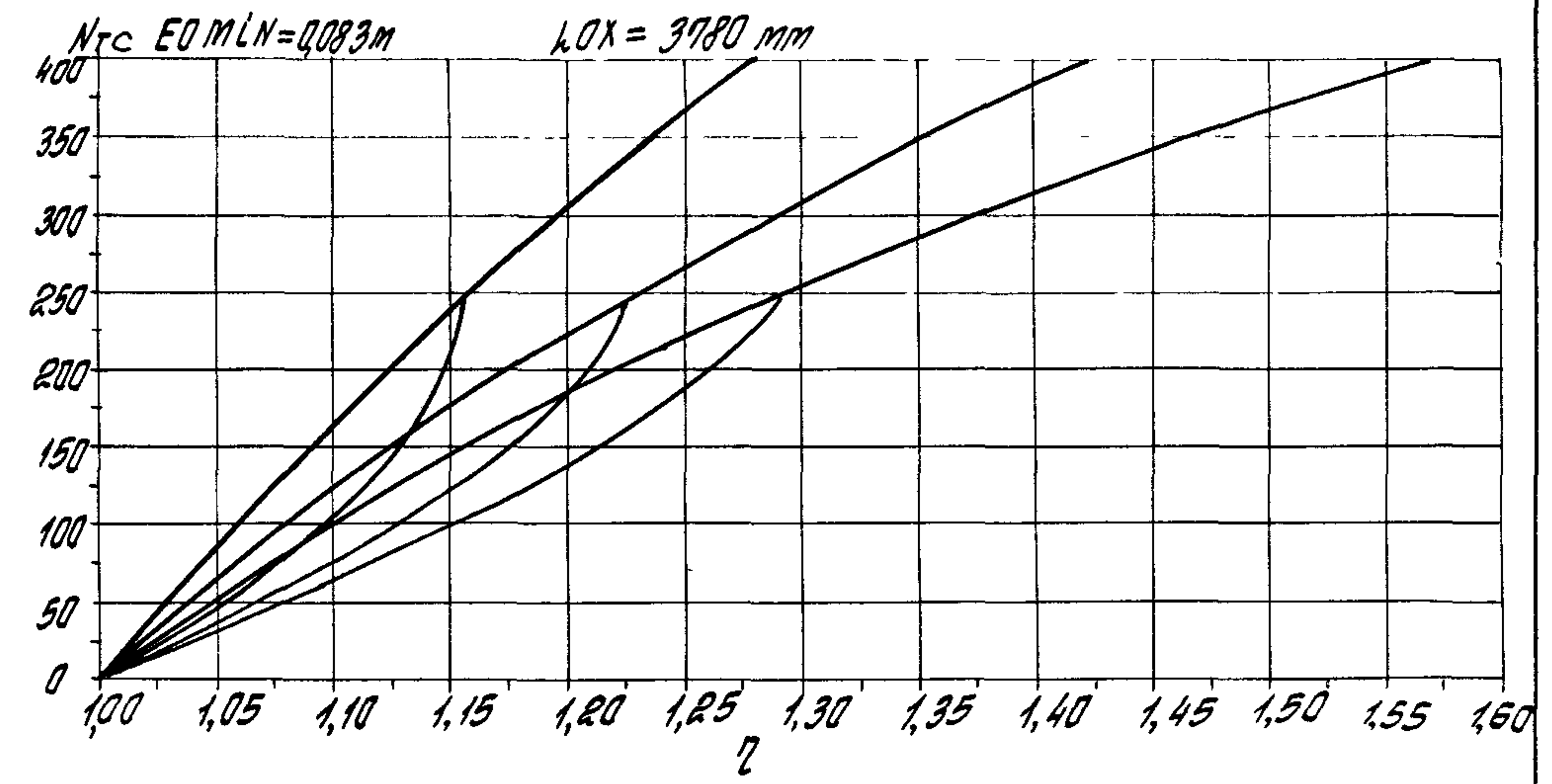
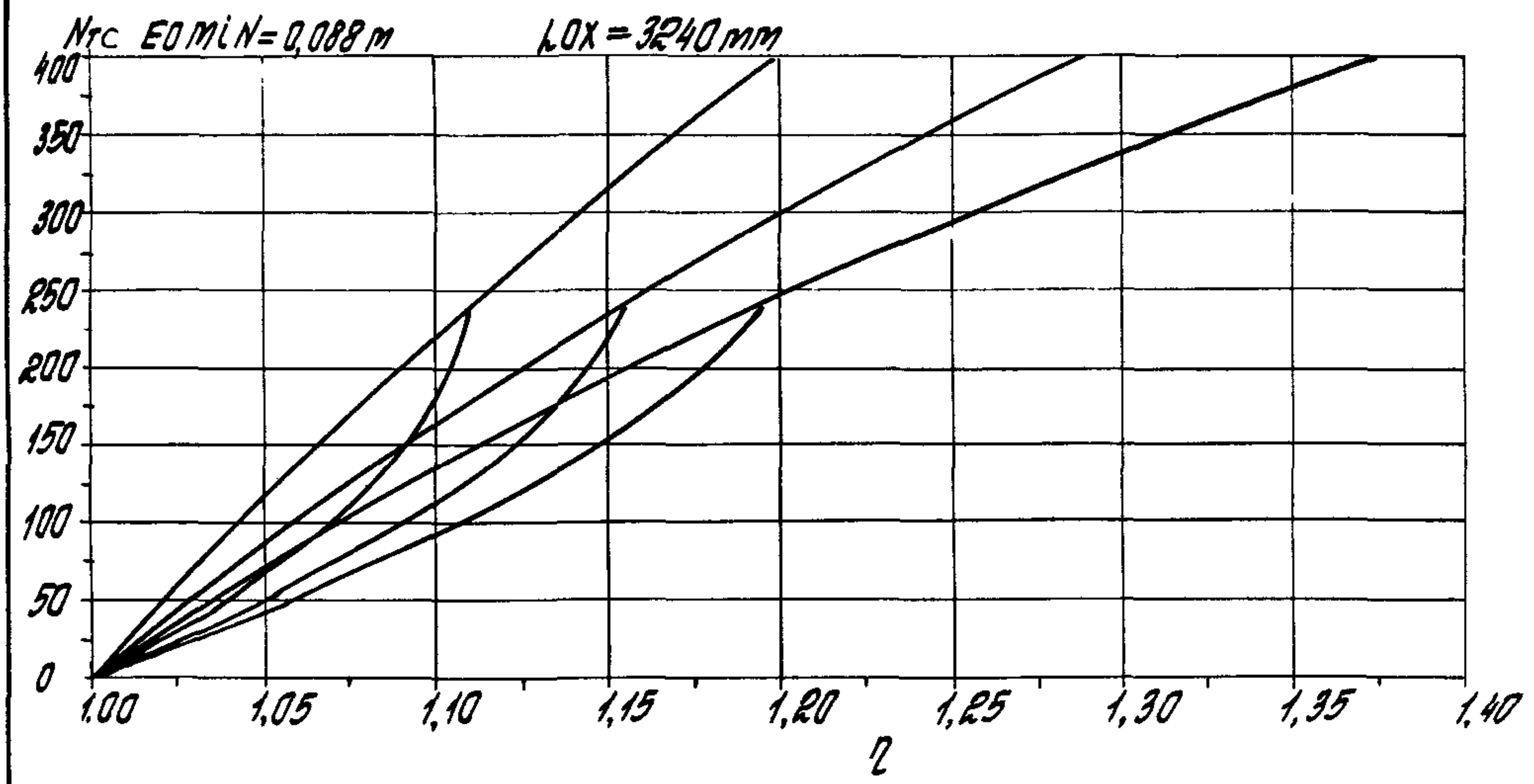

Ушб. № 70800. Дирекция Ушб. № 70800. Восток Ушб. № 70800.

1.020.1-4 0-9 002	Ушб. № 118
-------------------	------------

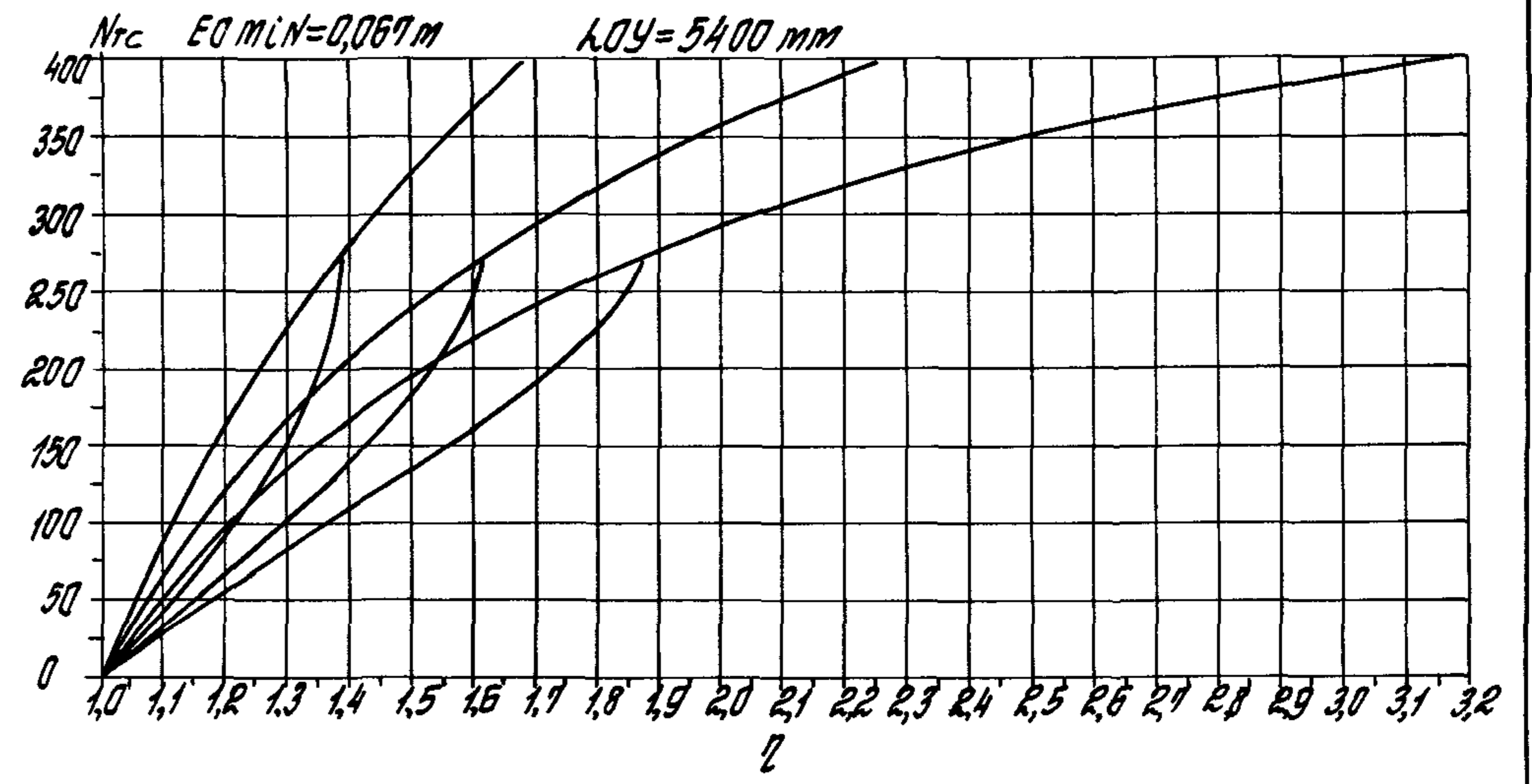
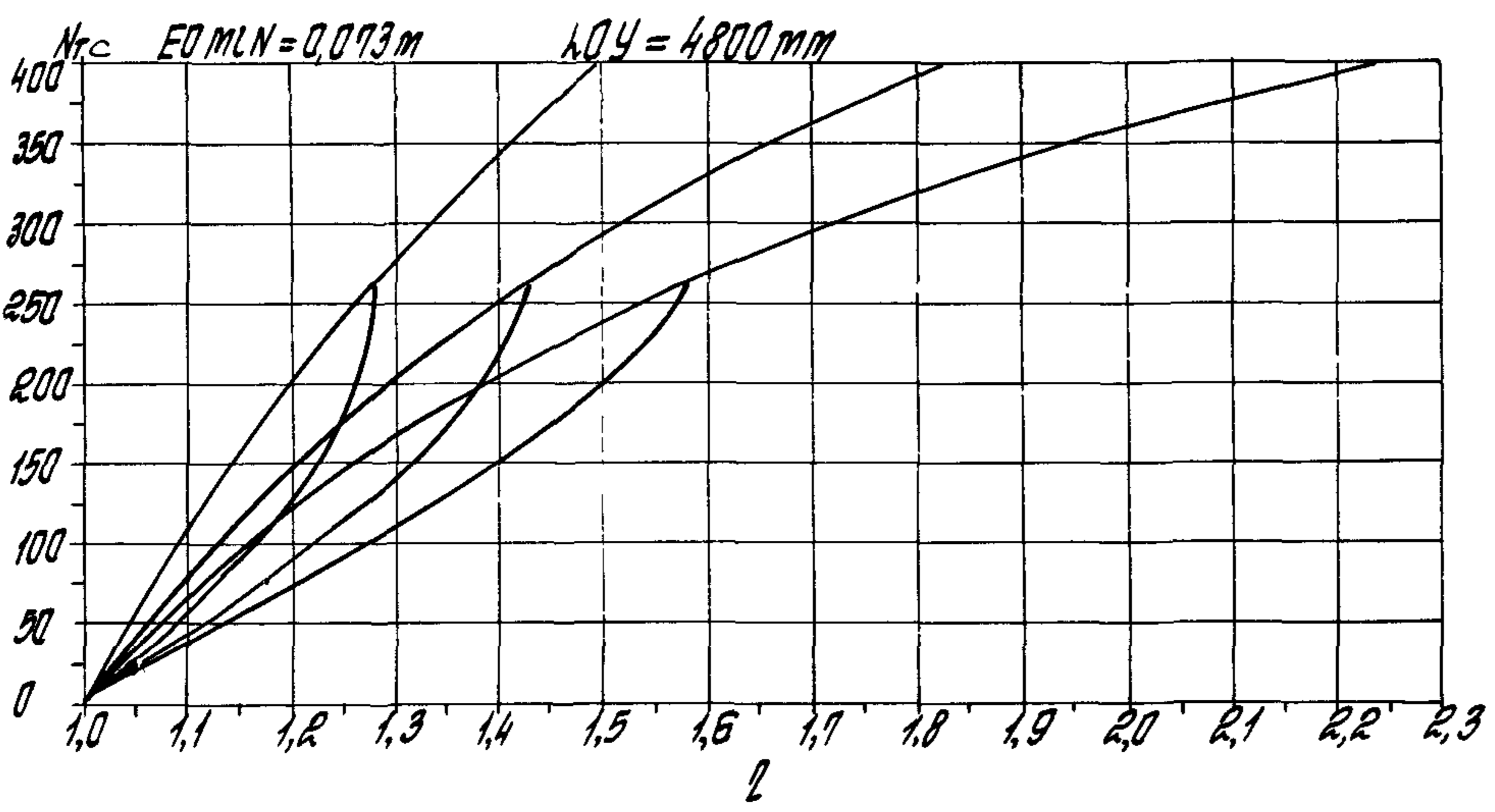
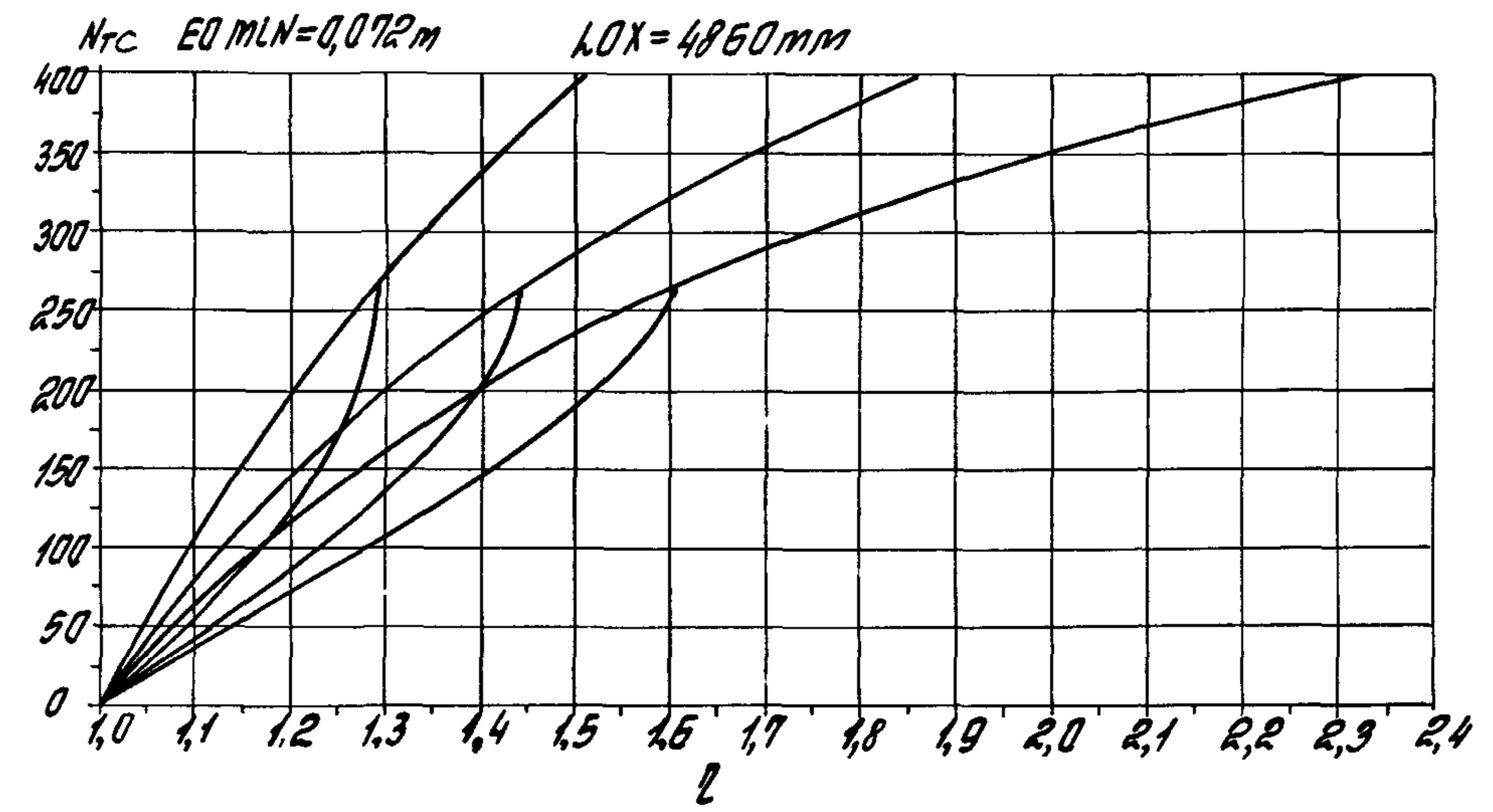
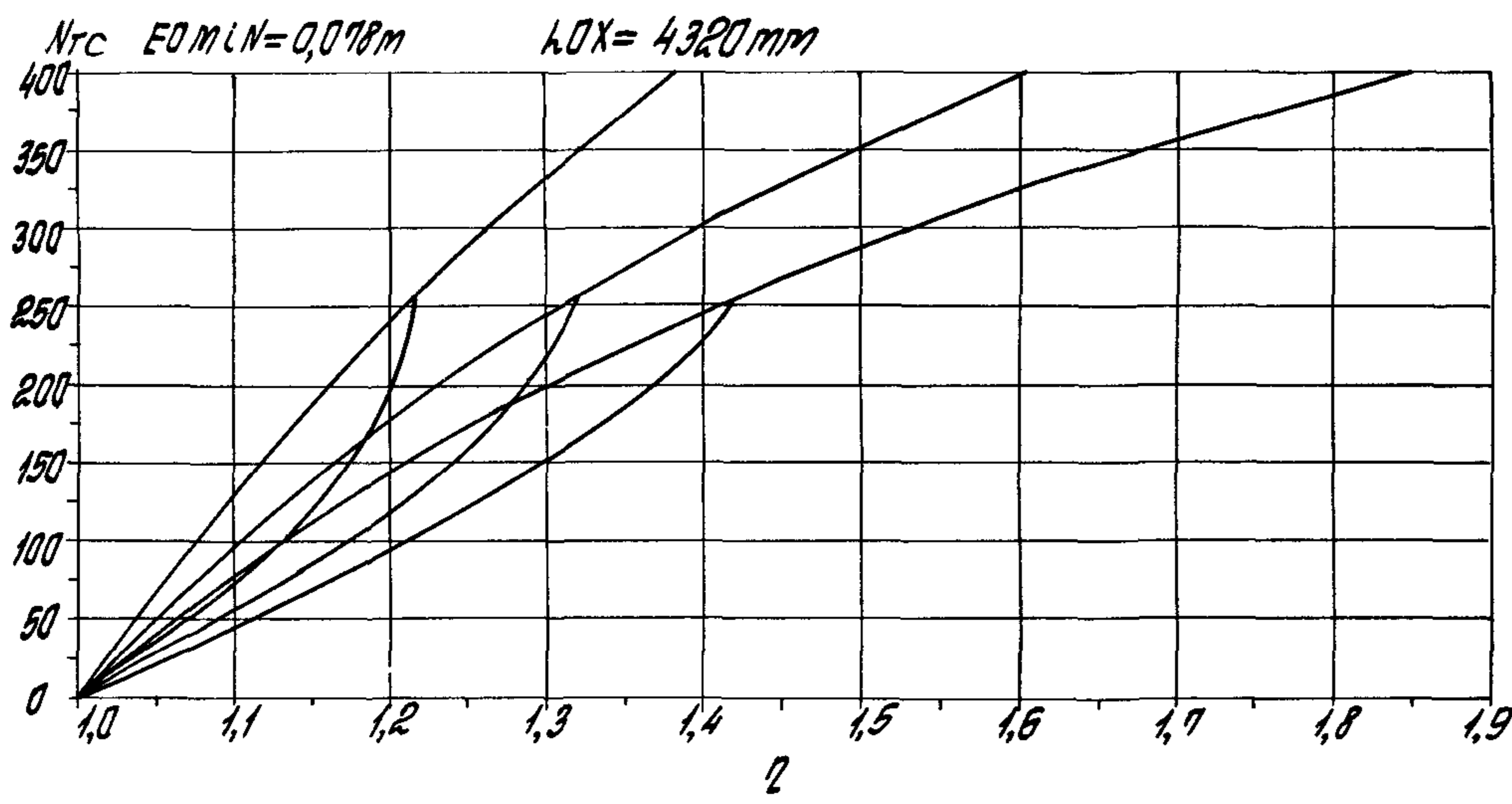

ВНИМАНИЕ! ВОЗМОЖНОСТЬ ПОСЛЕДОВАТЕЛЬНОГО ПОДЪЕМА

1.020.1-4 0-9 002

Итем
119

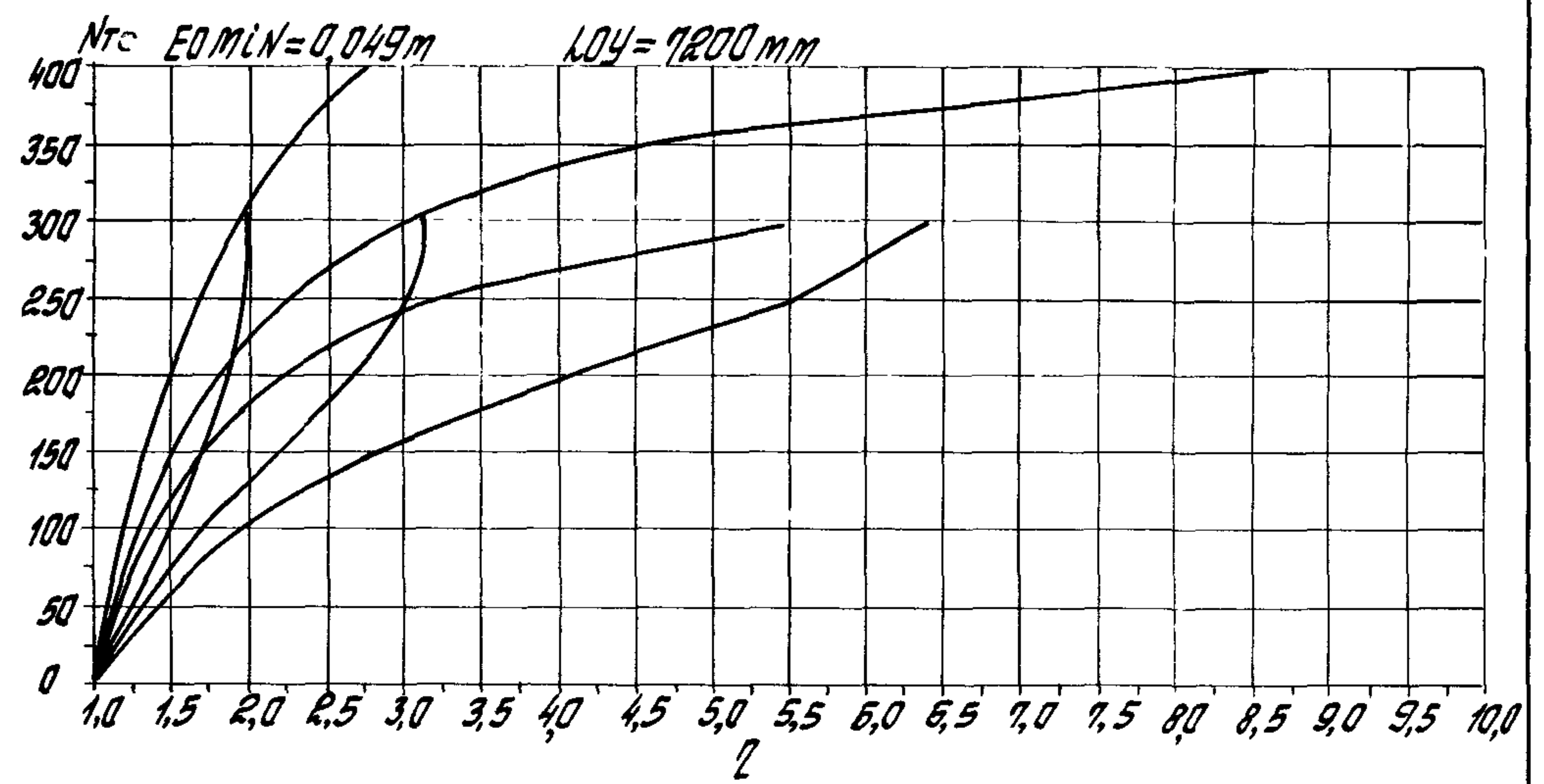
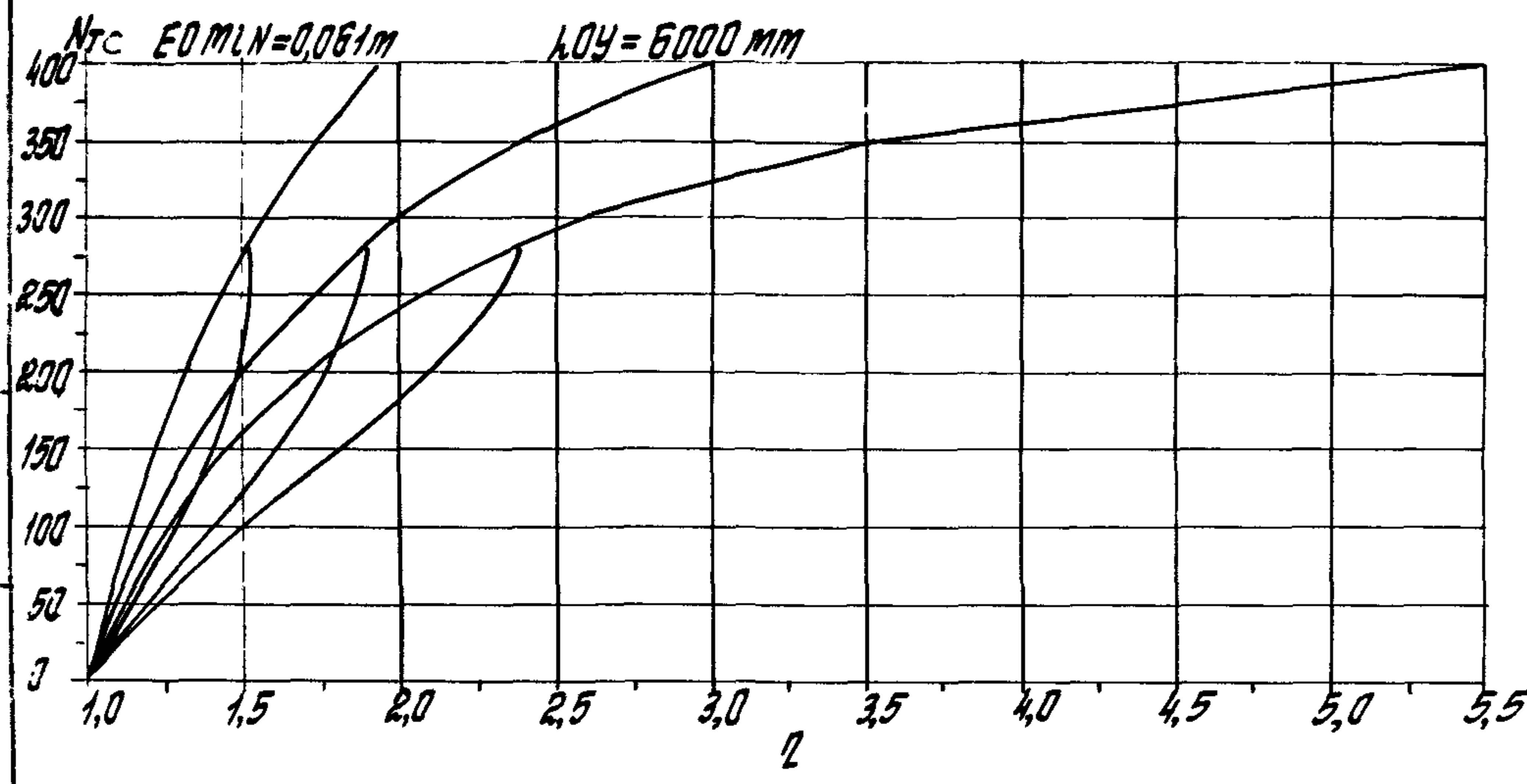
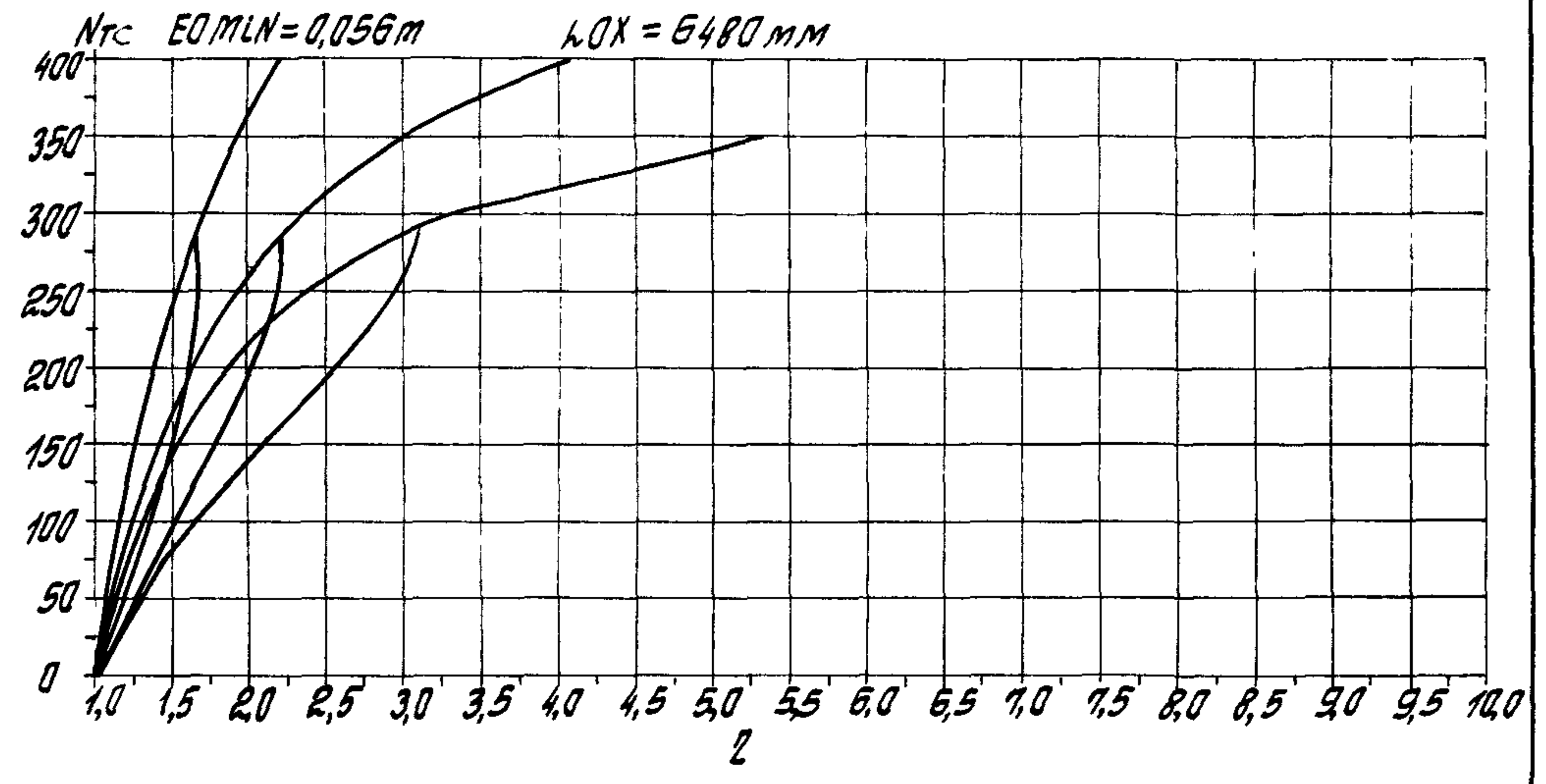
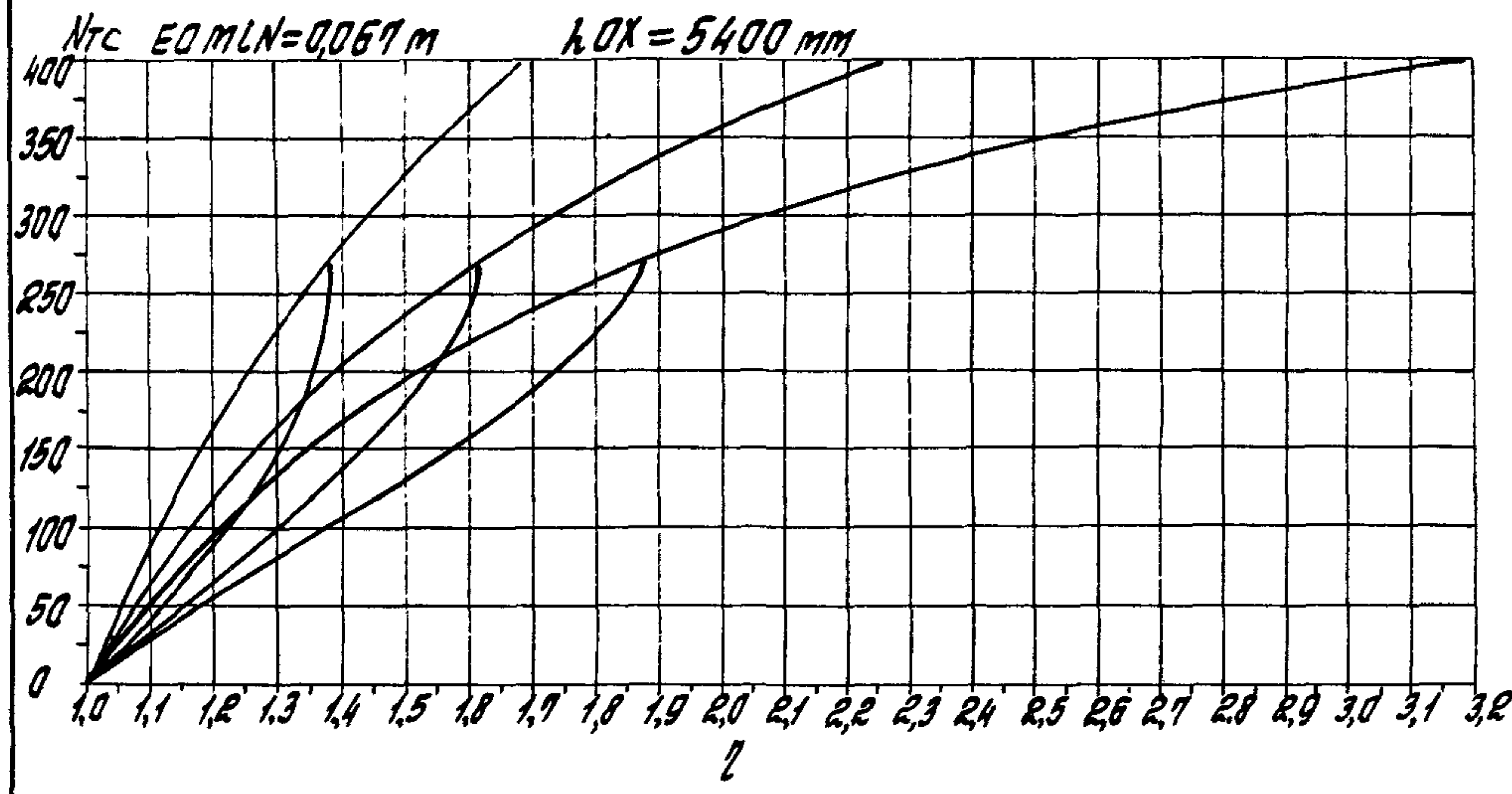

1.020.1-4 7-9 002
 120

1.020.1-4 7-9 002 120

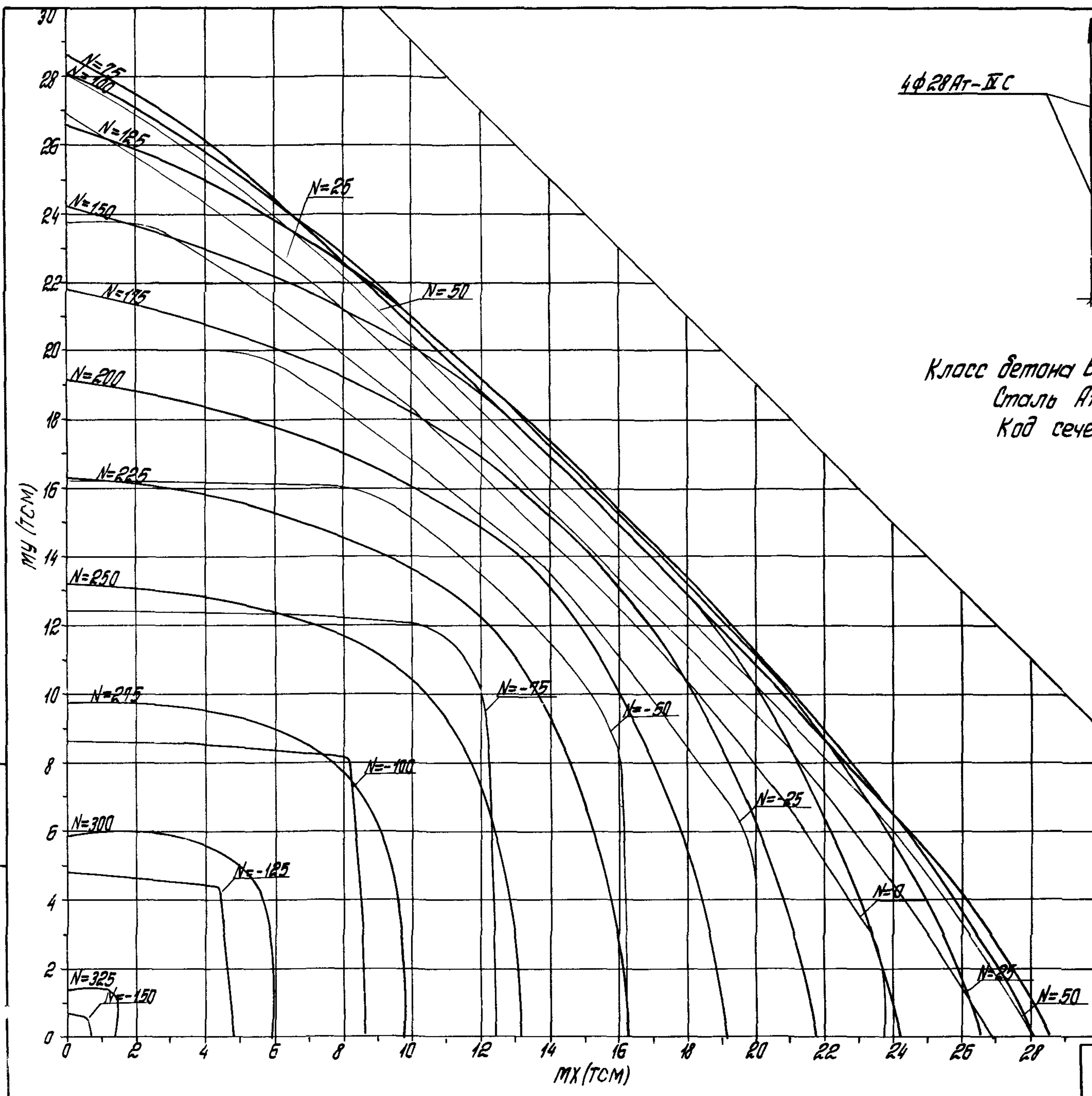

4φ28Aт-IVс

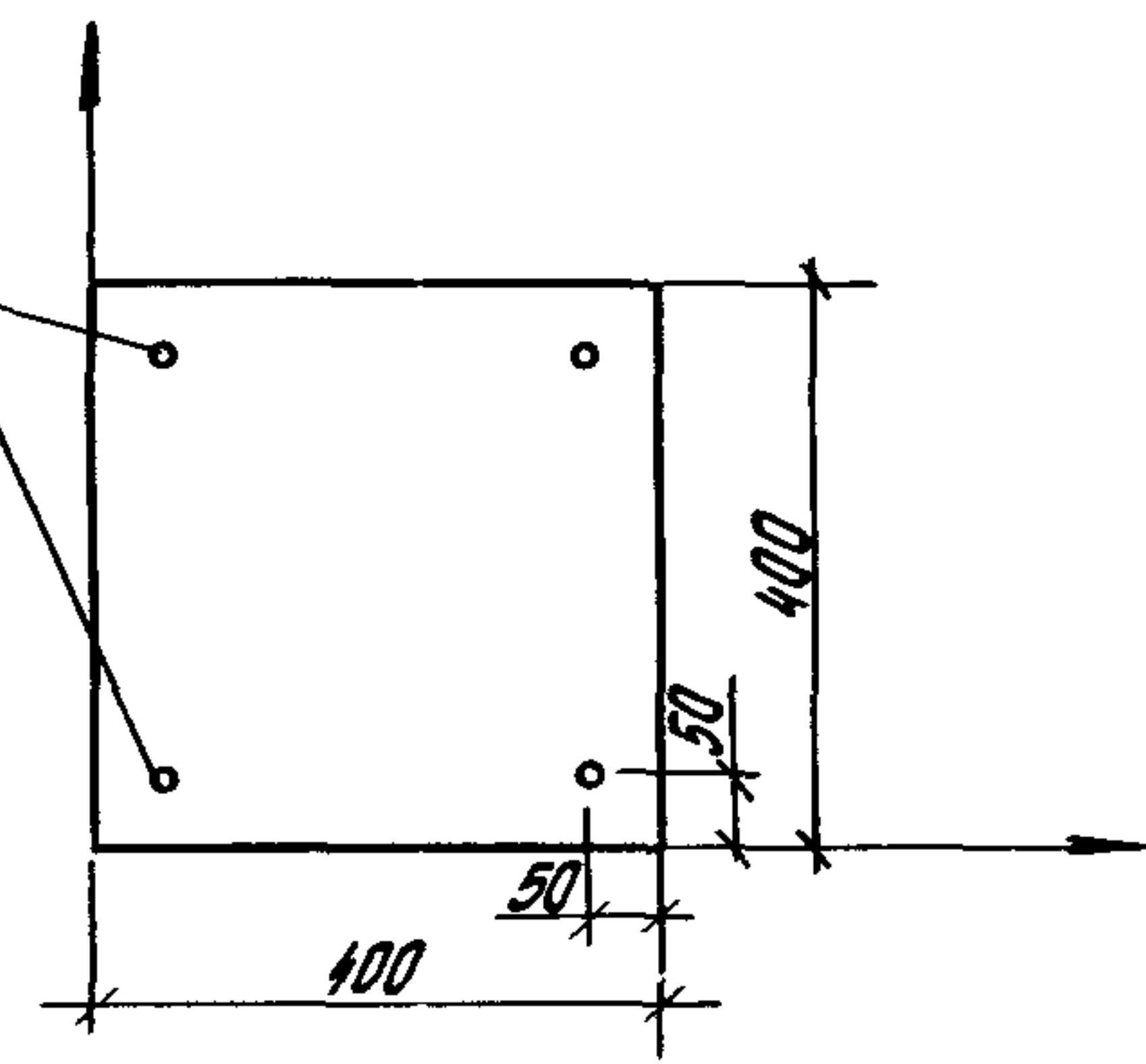

Класс бетона В22,5 ($R_b = 14,3 \text{ МПа}$ при учете $\gamma_{b2} = 1,10$)
 Сталь Ат-IVс
 Код сечения - 116а

1.020. 1-4	0-9 002	Лист 121
------------	---------	-------------

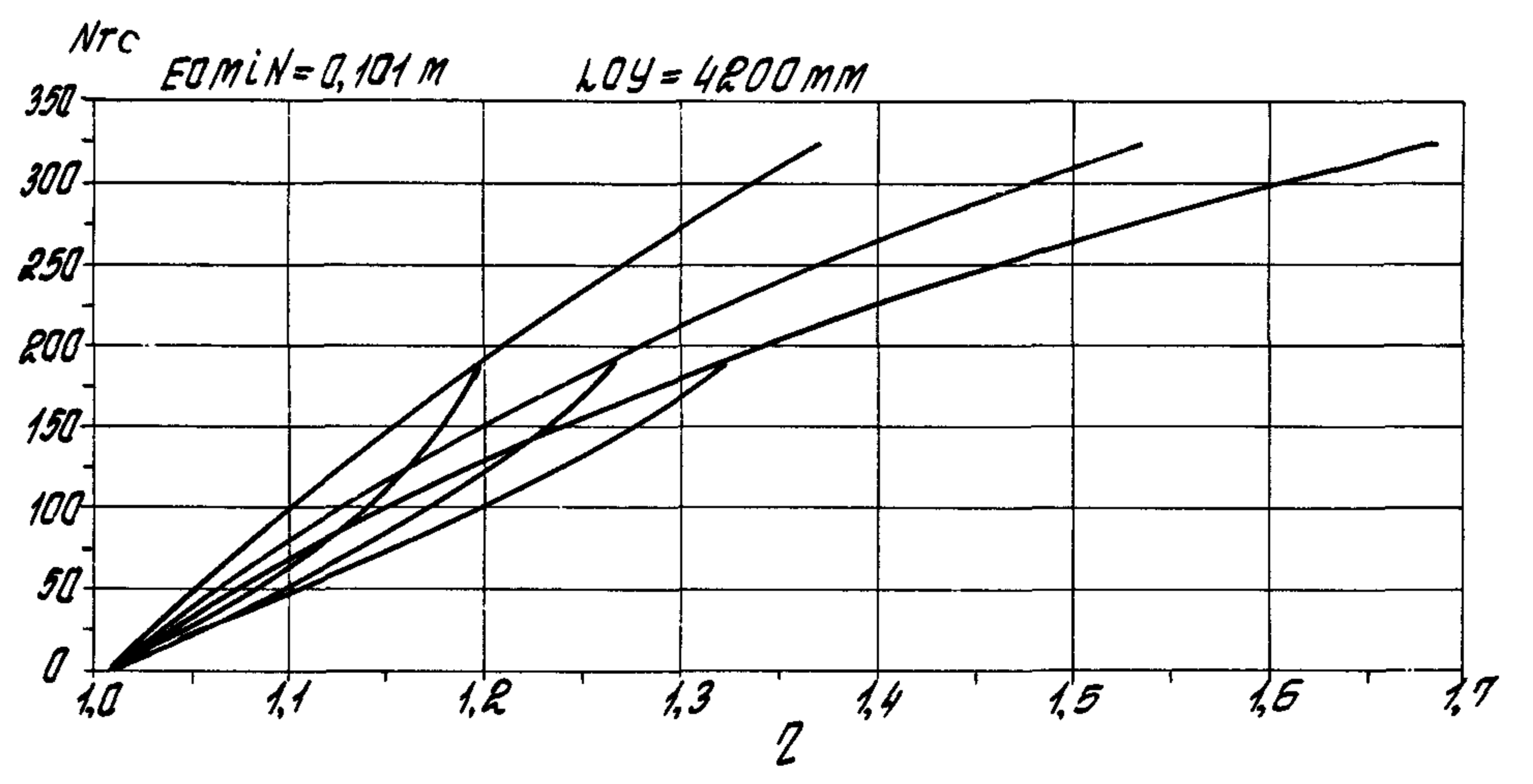
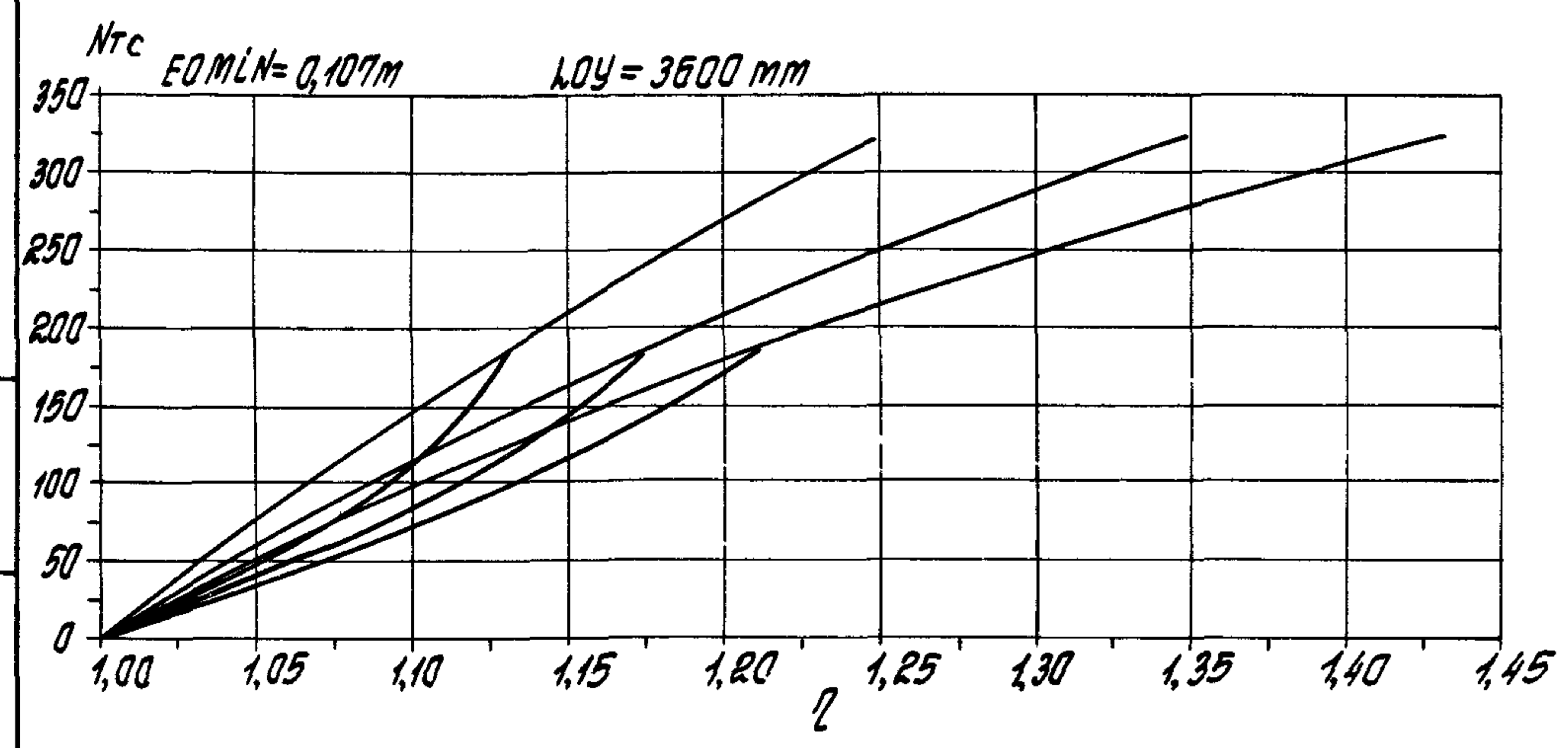
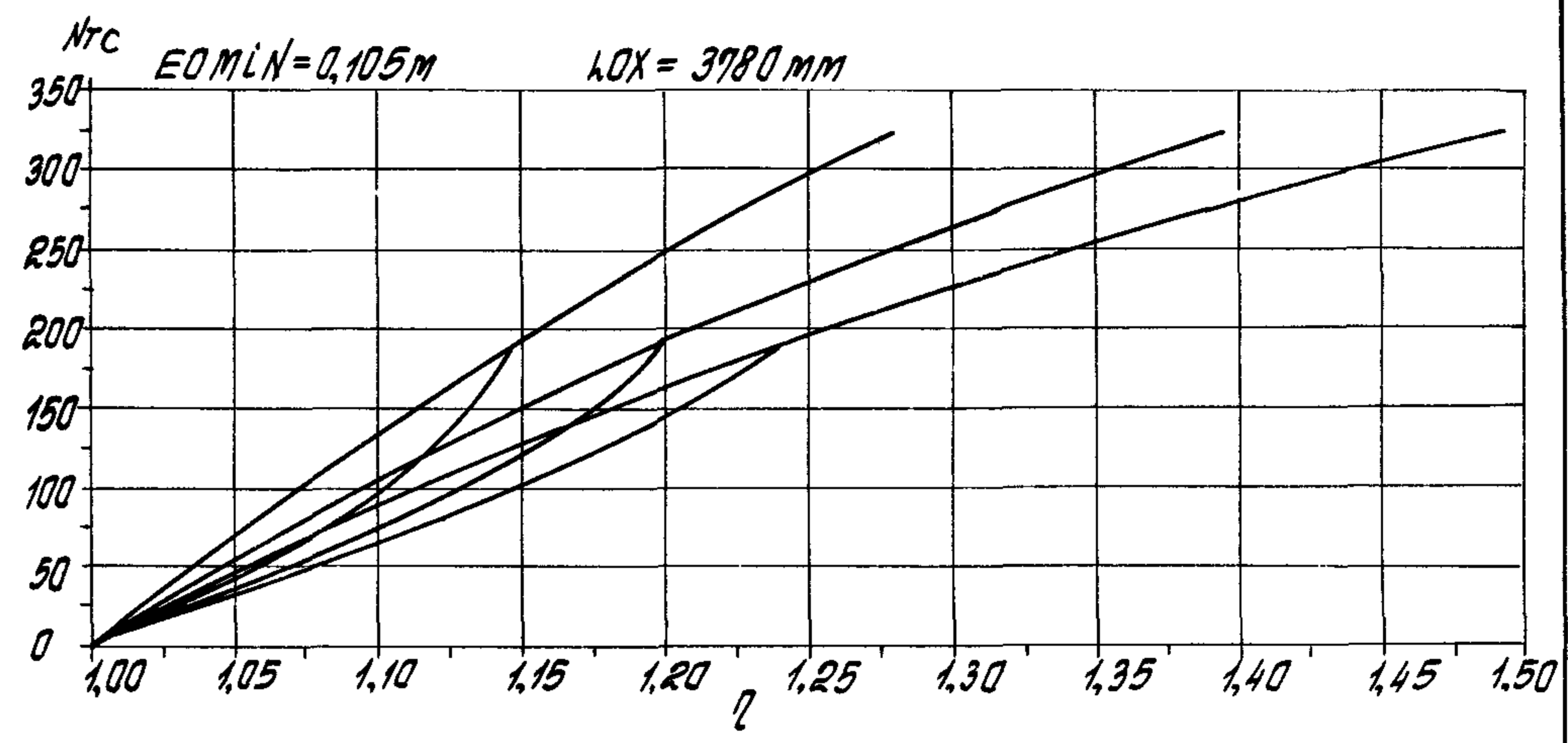
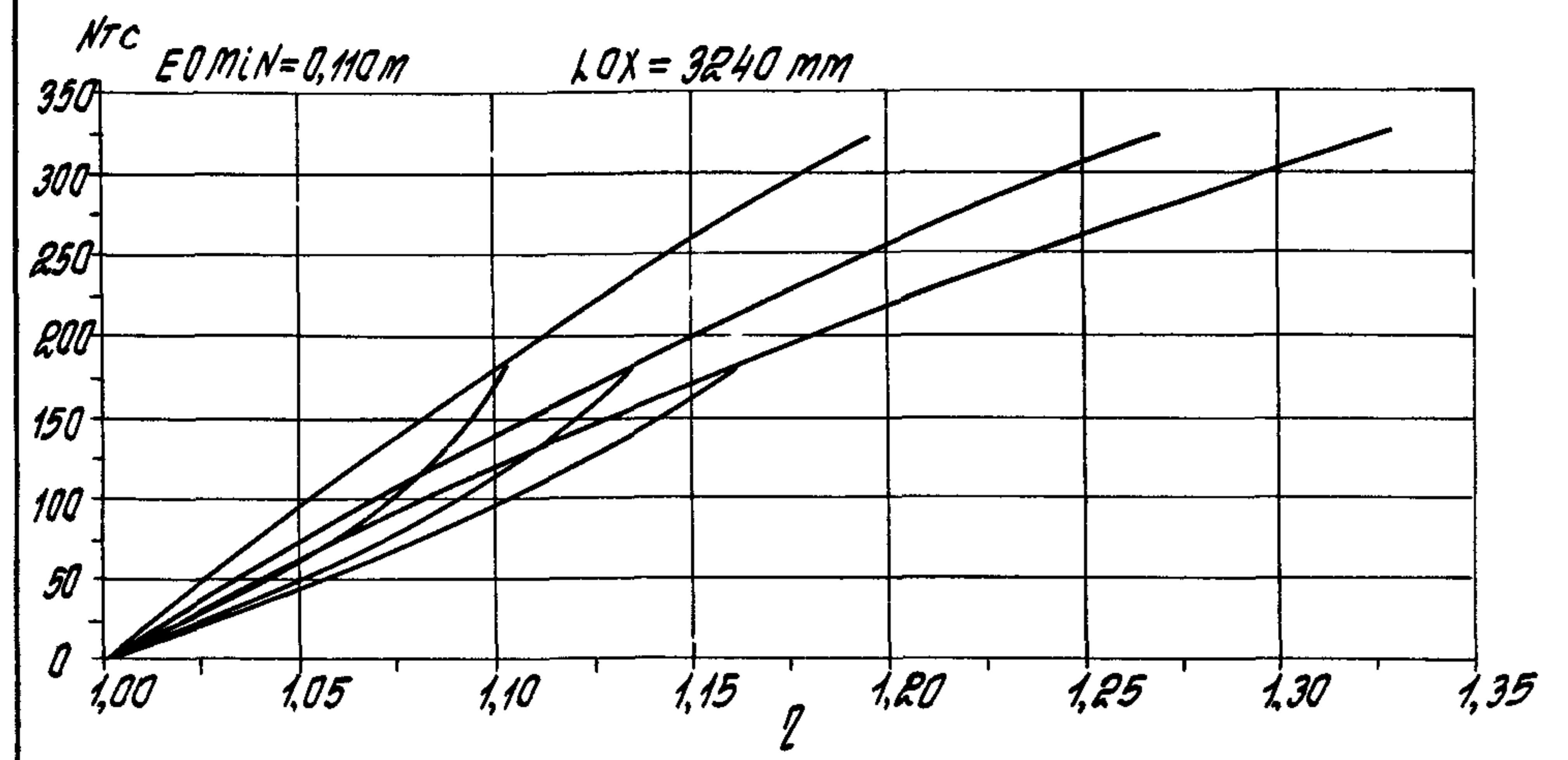

1.020.1-4 0-9 002

<i>Лучм</i>
122

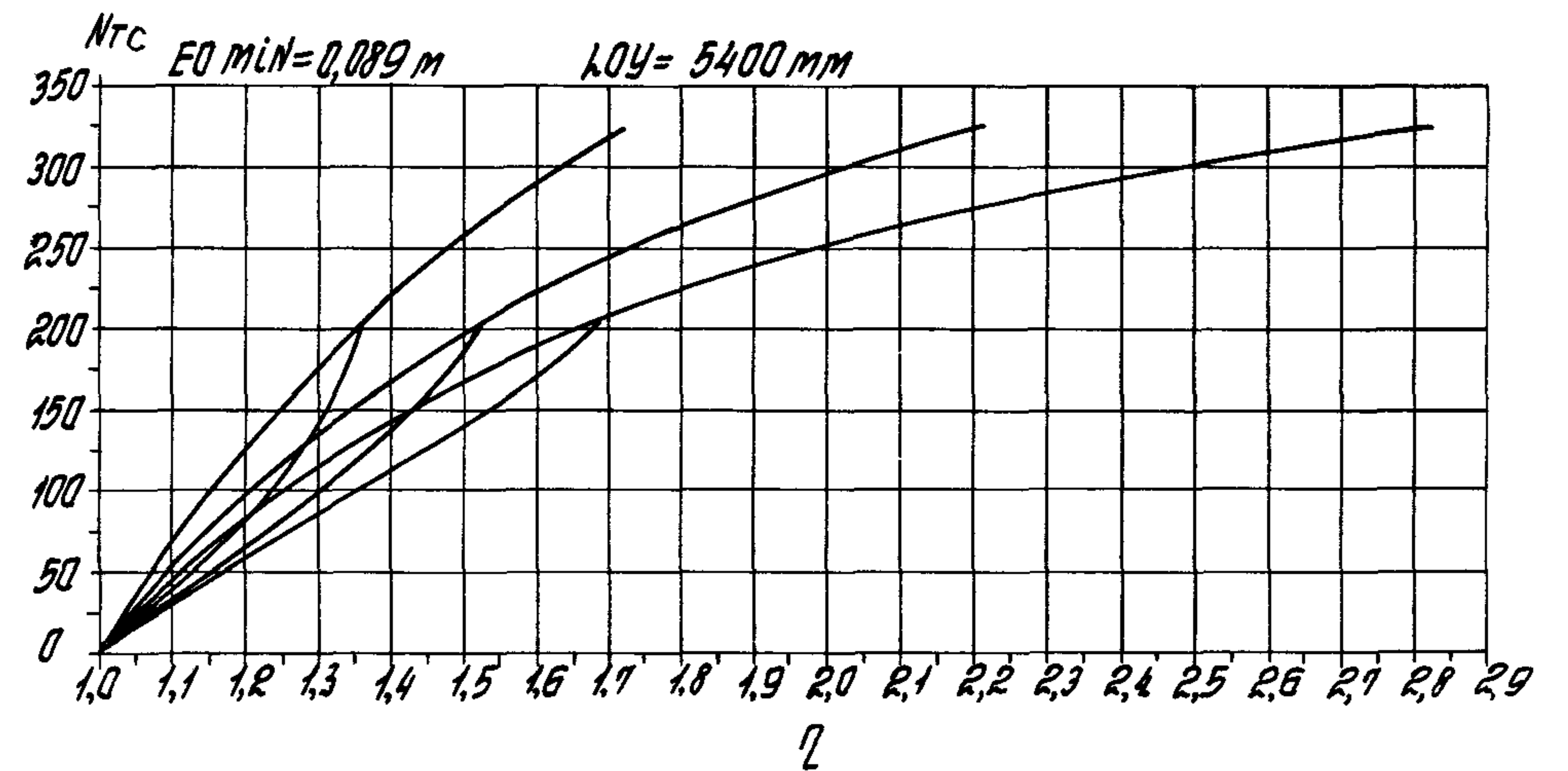
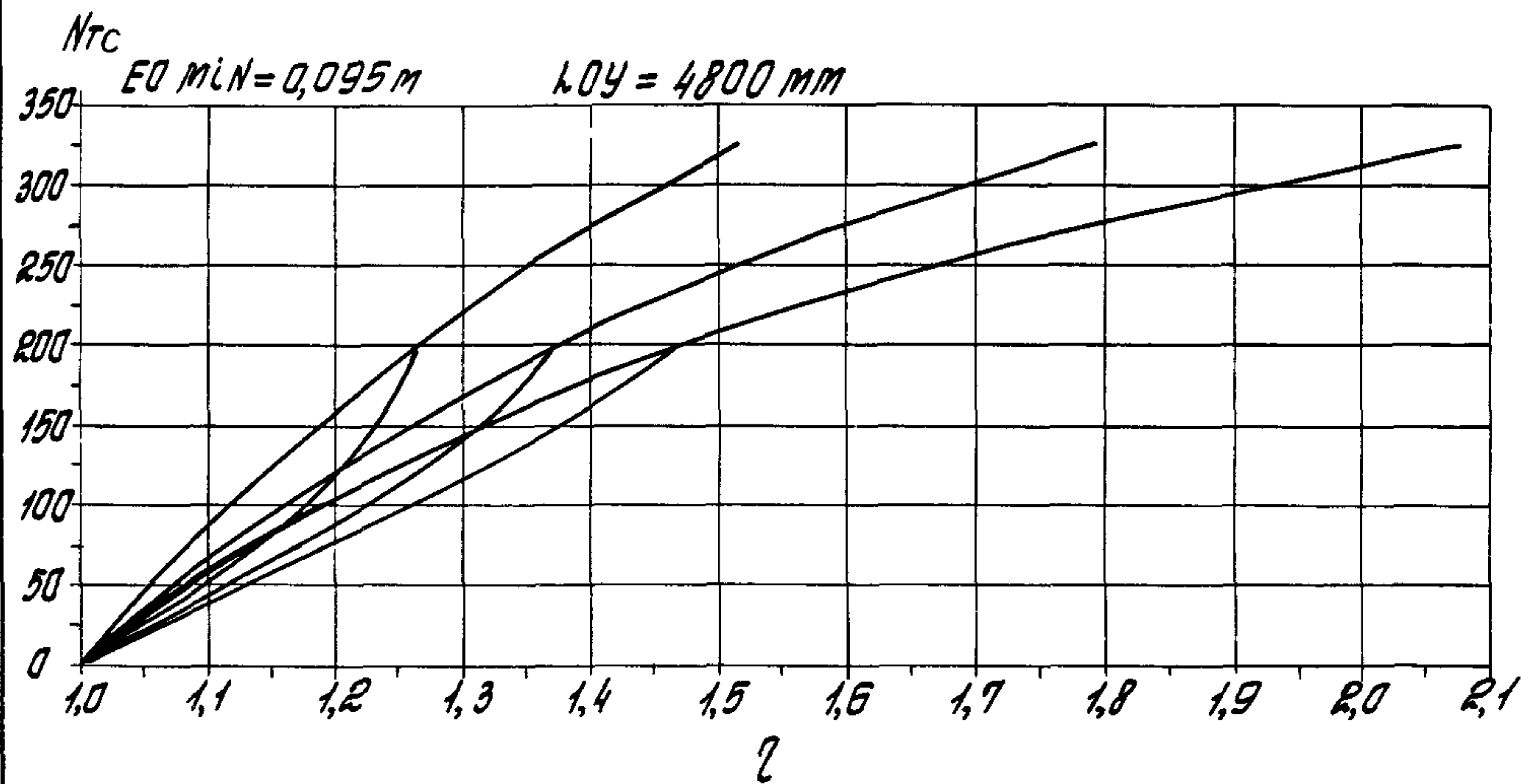
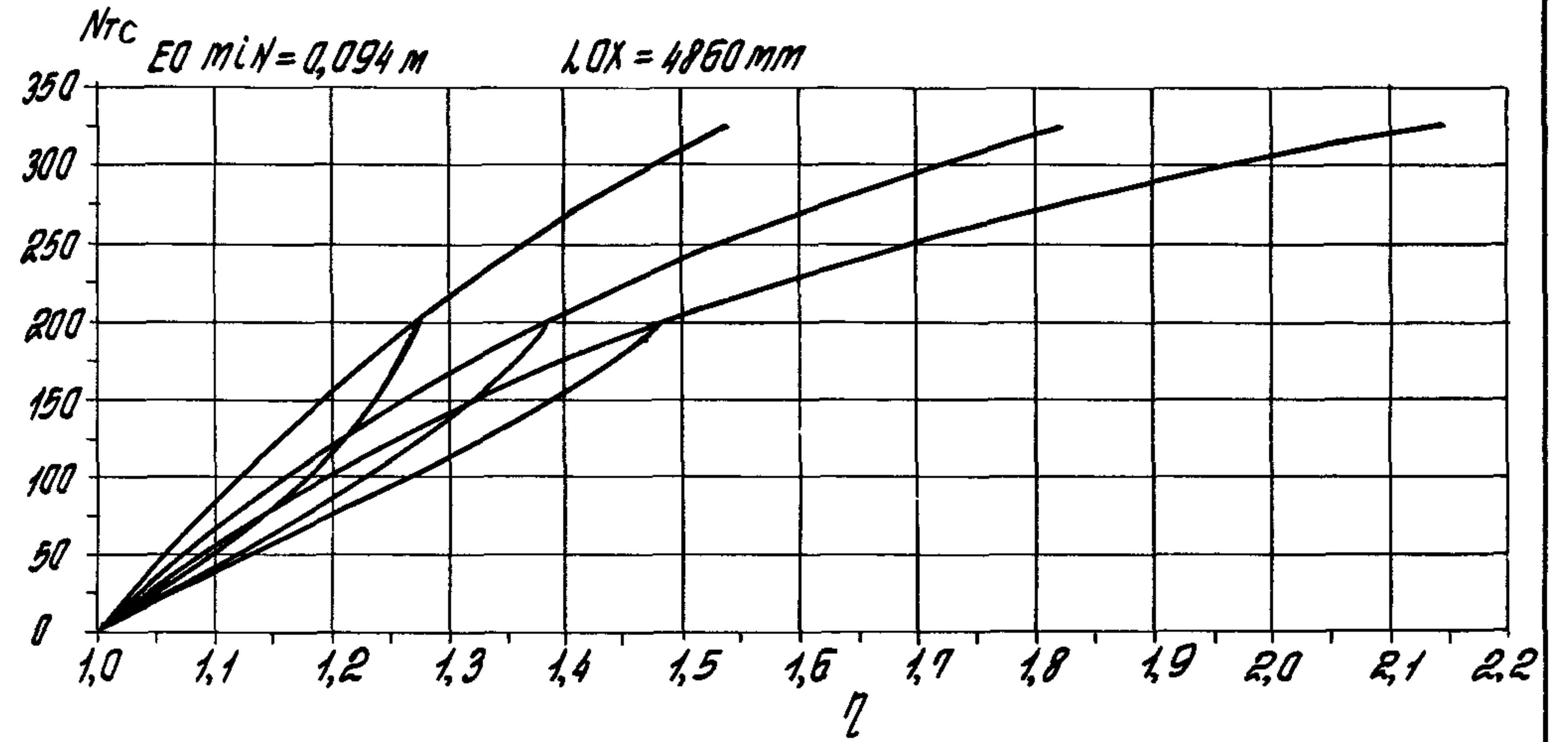
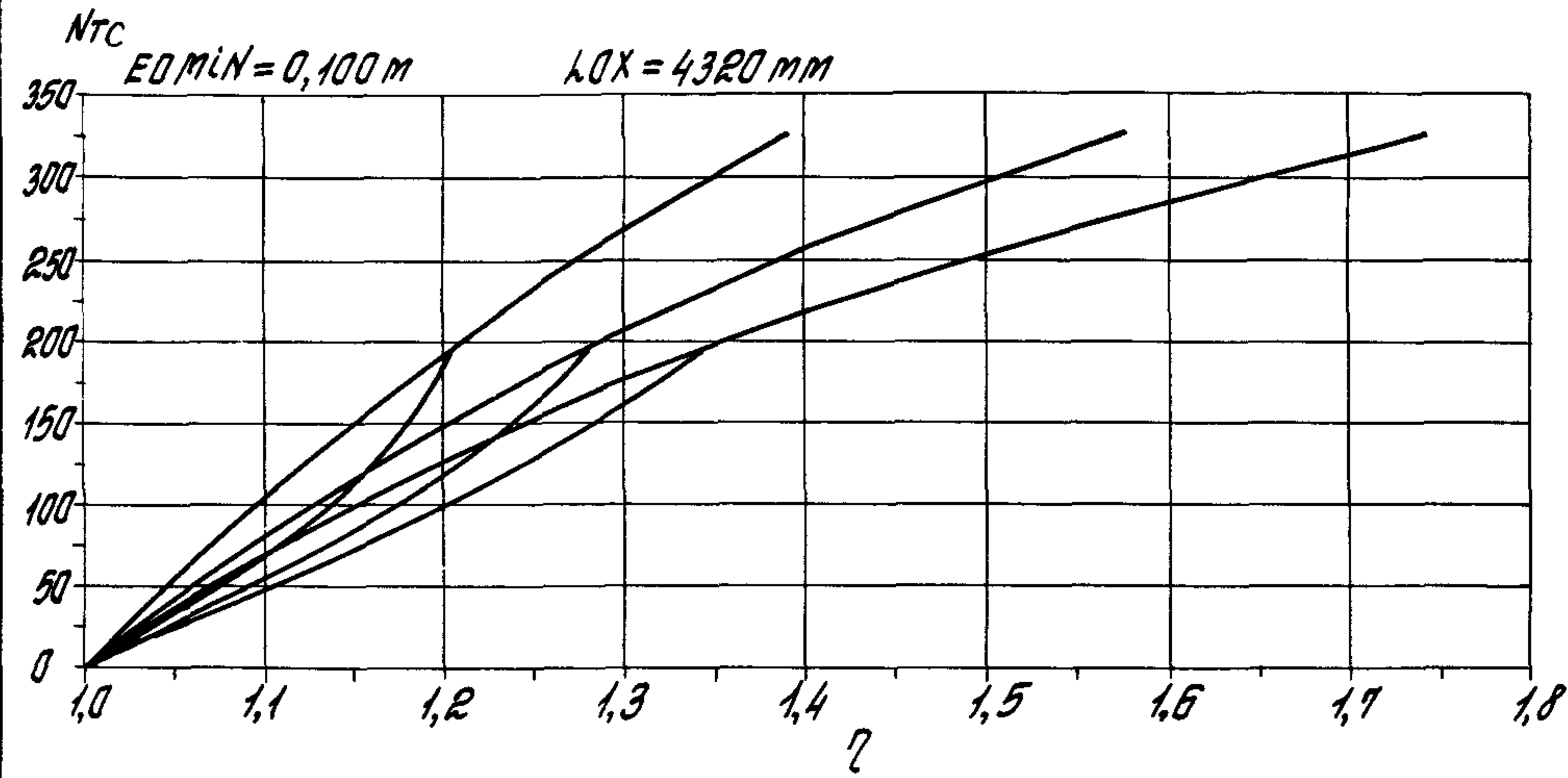

Учб. № 10001 Подруч. 1-го изд. 1900 м. № 46

1.020. 1-4	0-9 302	л/см
		123

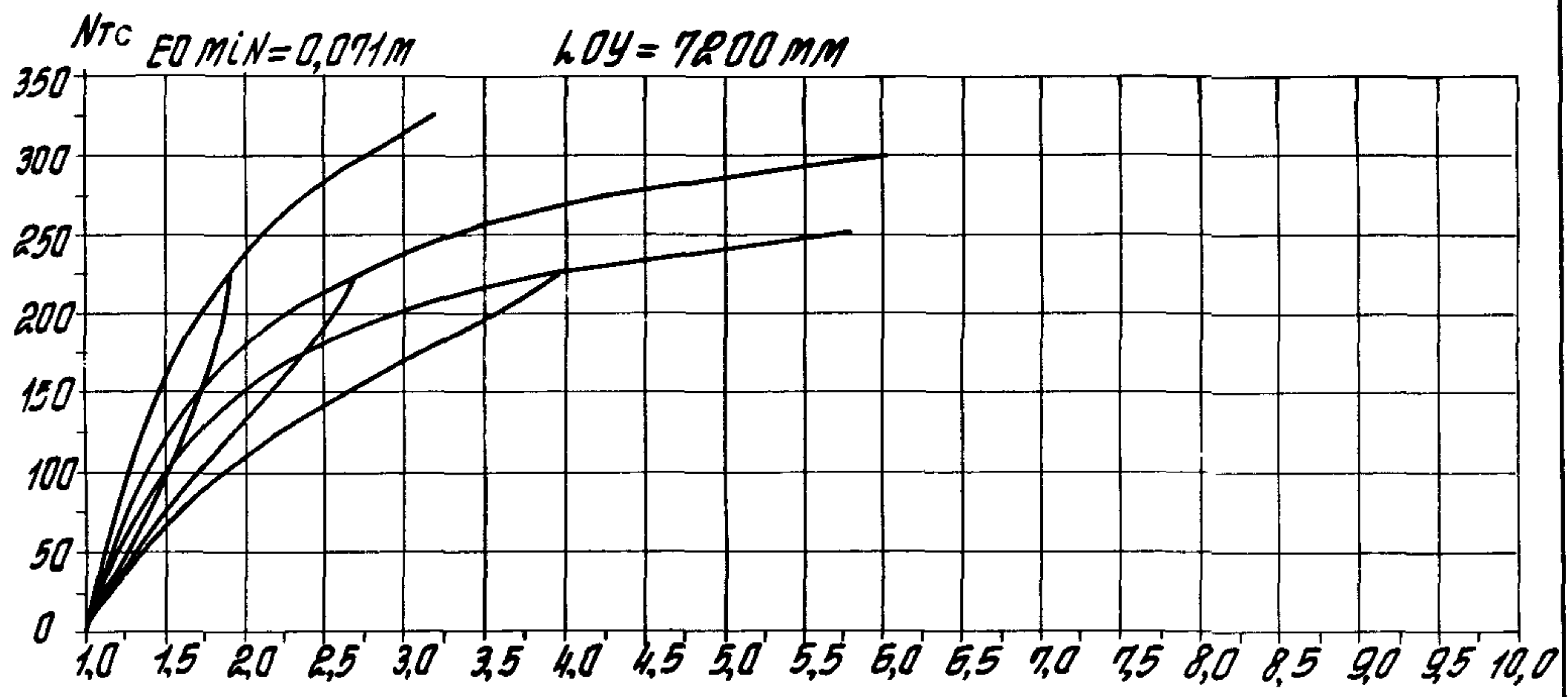
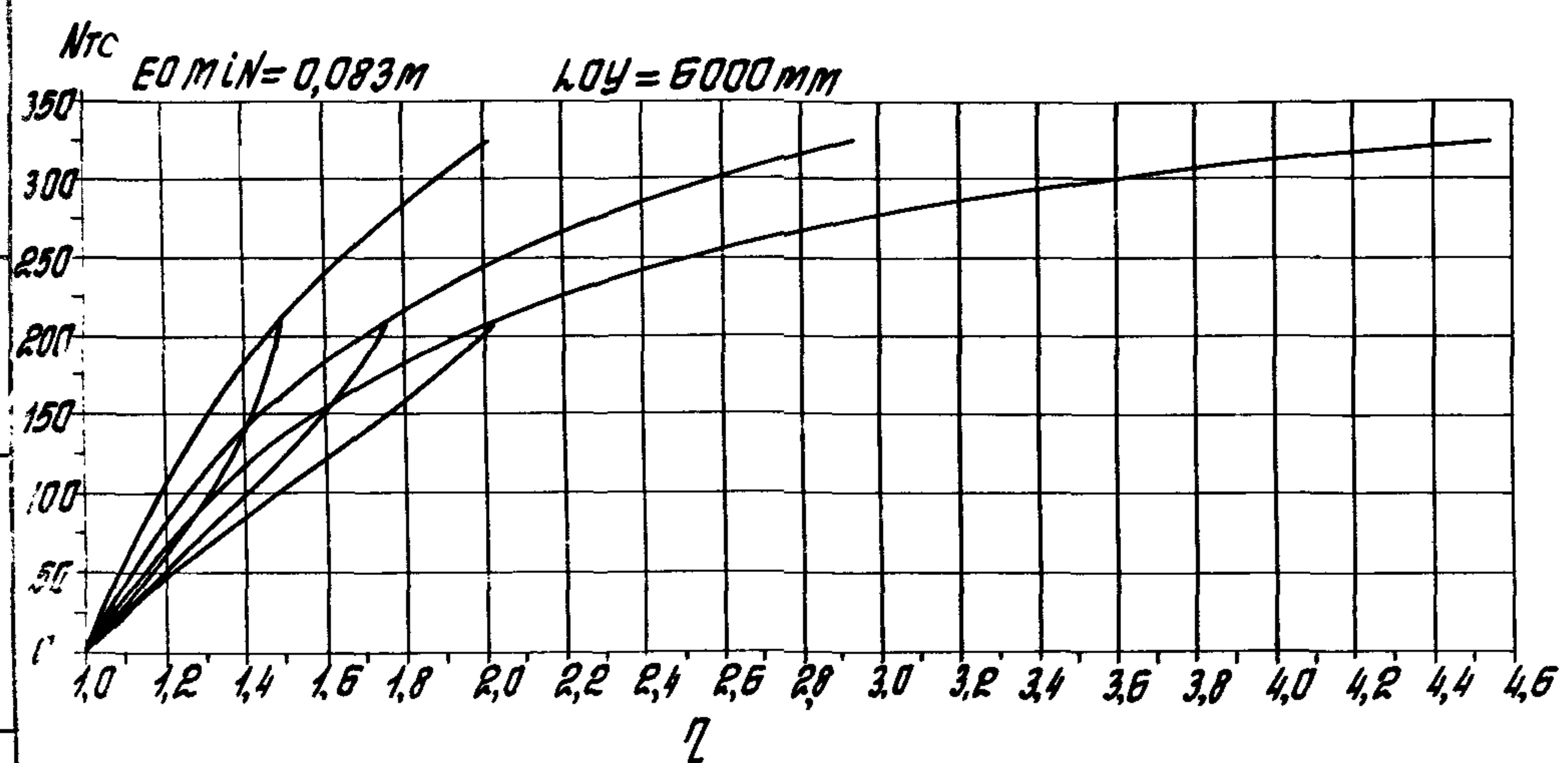
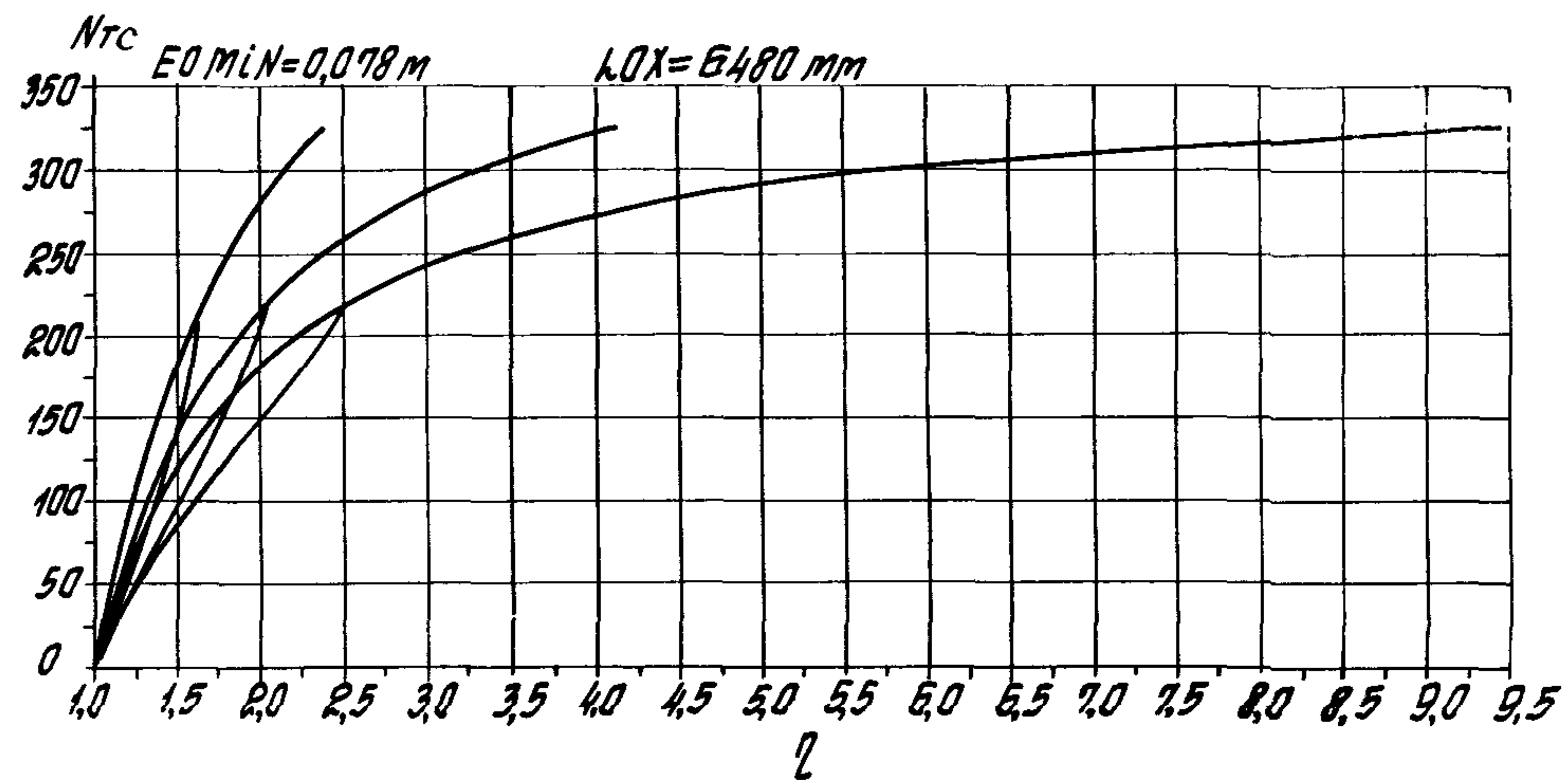
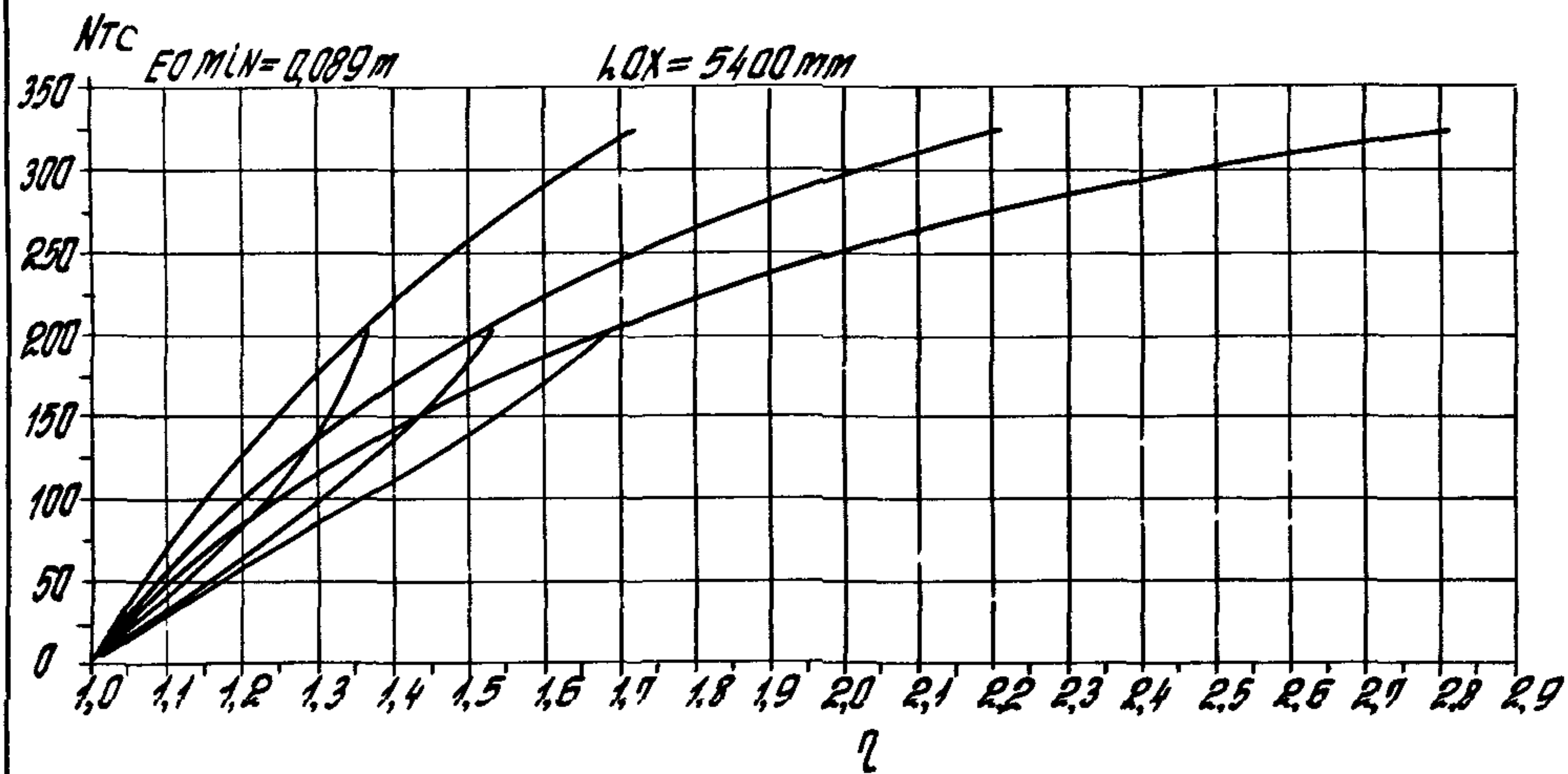

Лист № 10001. Видовое и общее изображение

1.020. 1-4	0-9 002	Лист
		124

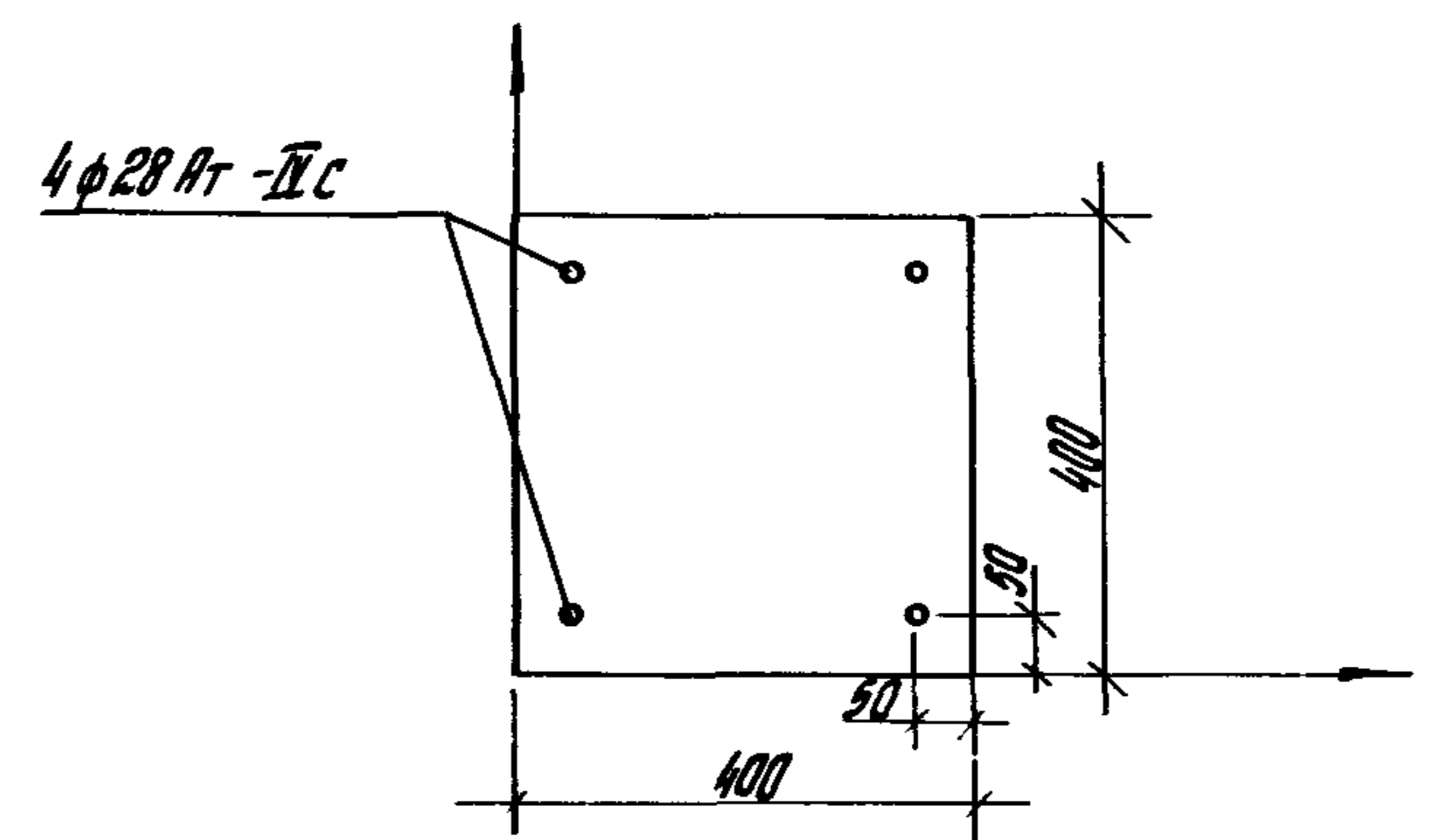
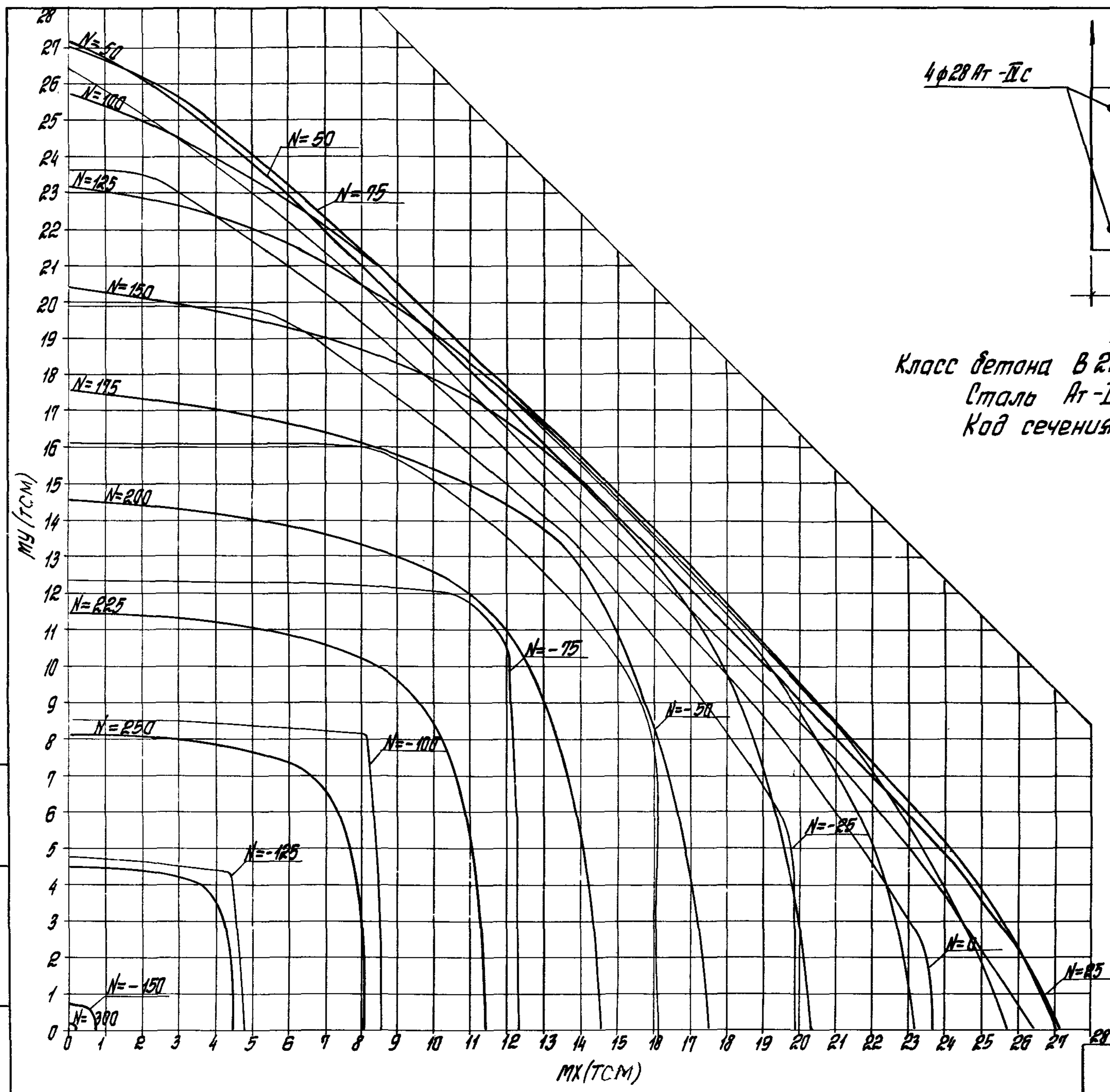

4φ28 Ат-IVс
 (R_b=11,7
 Класс бетона В 22,5√MПа при учете γ_{b2} = 0,90)
 Сталь Ат-IVс
 Код сечения-116δ

Тип расчета: Момент и Погоня
 Видом учета: №

1.020.1-4 0-9 002 Метр
125

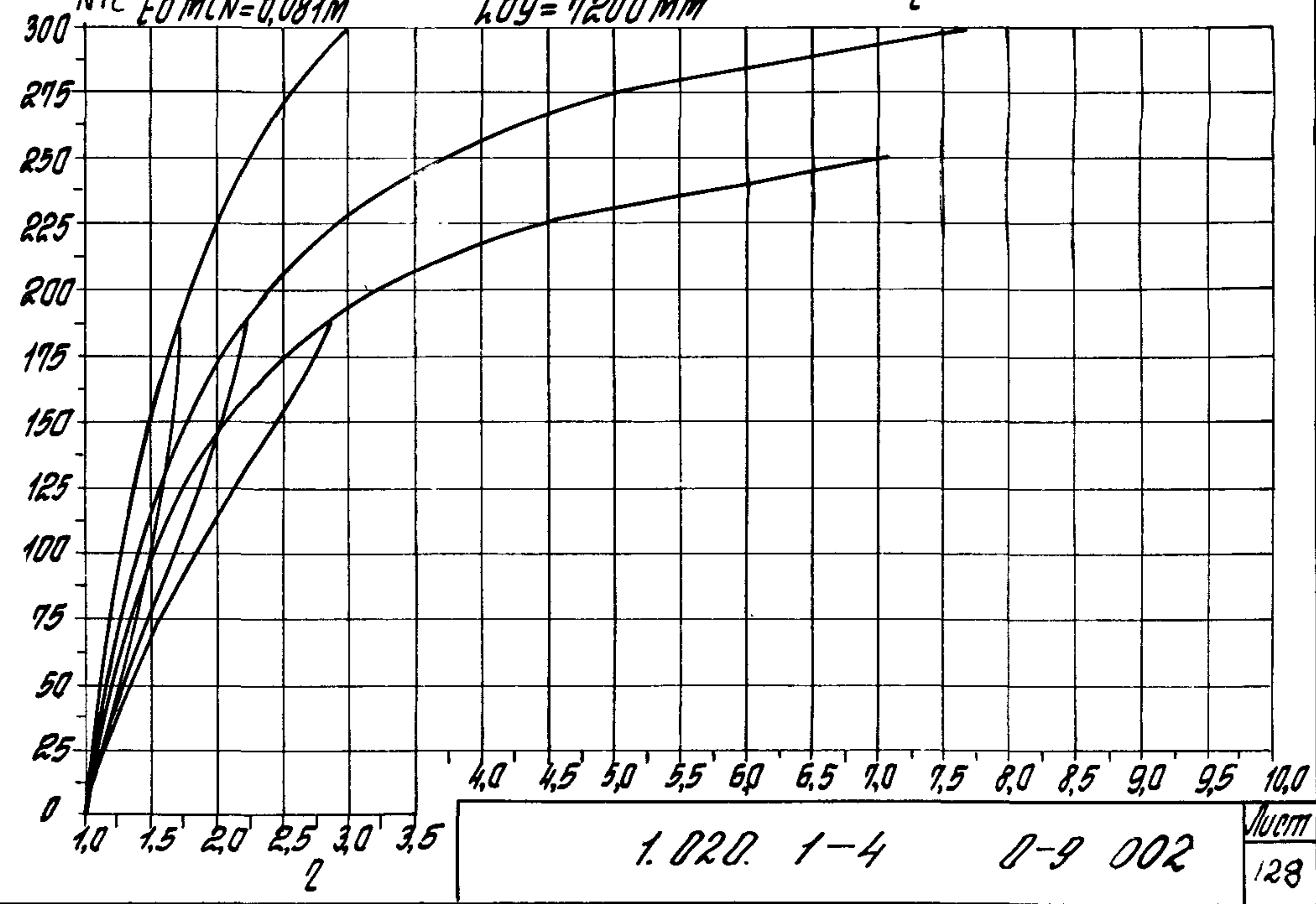
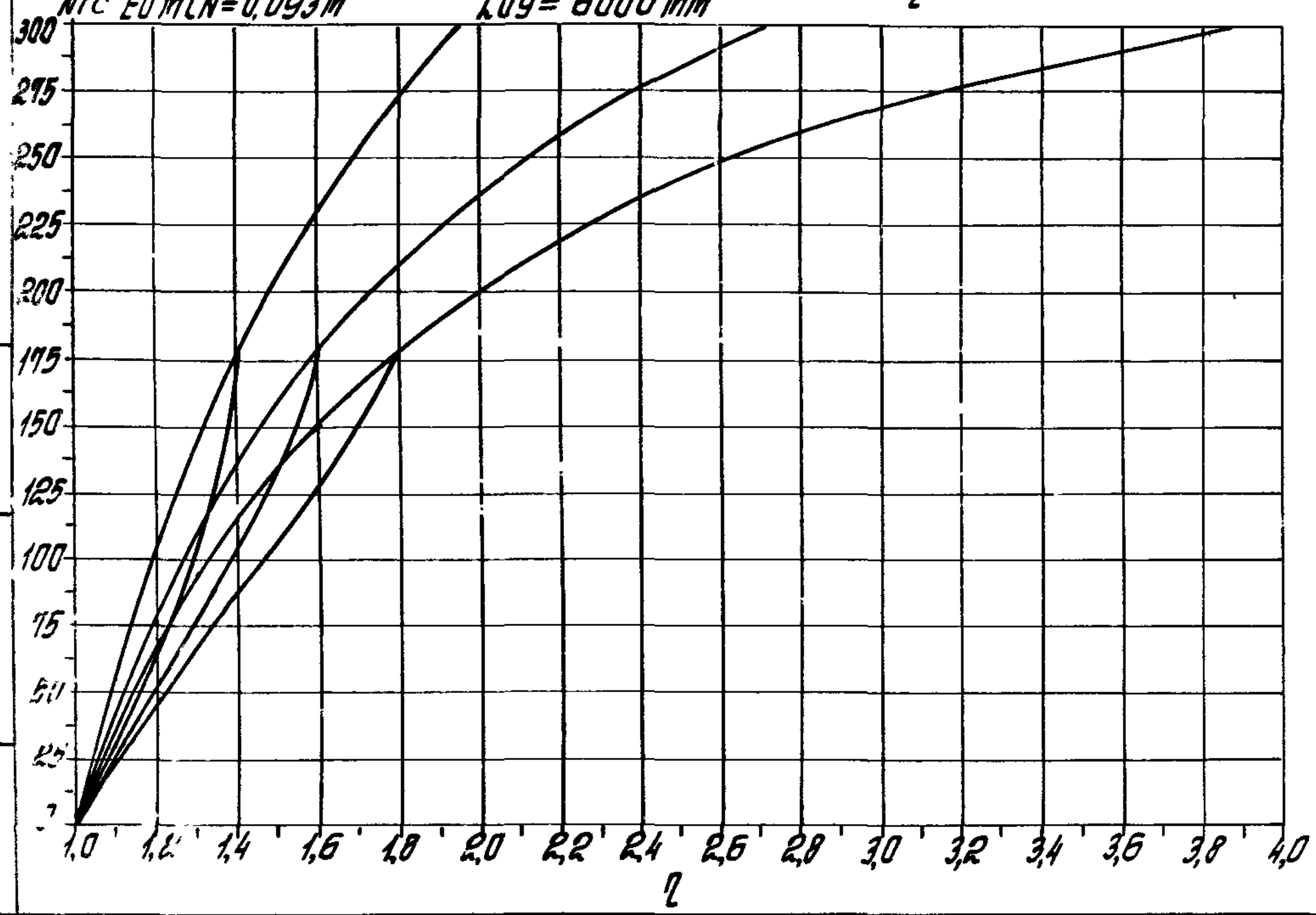
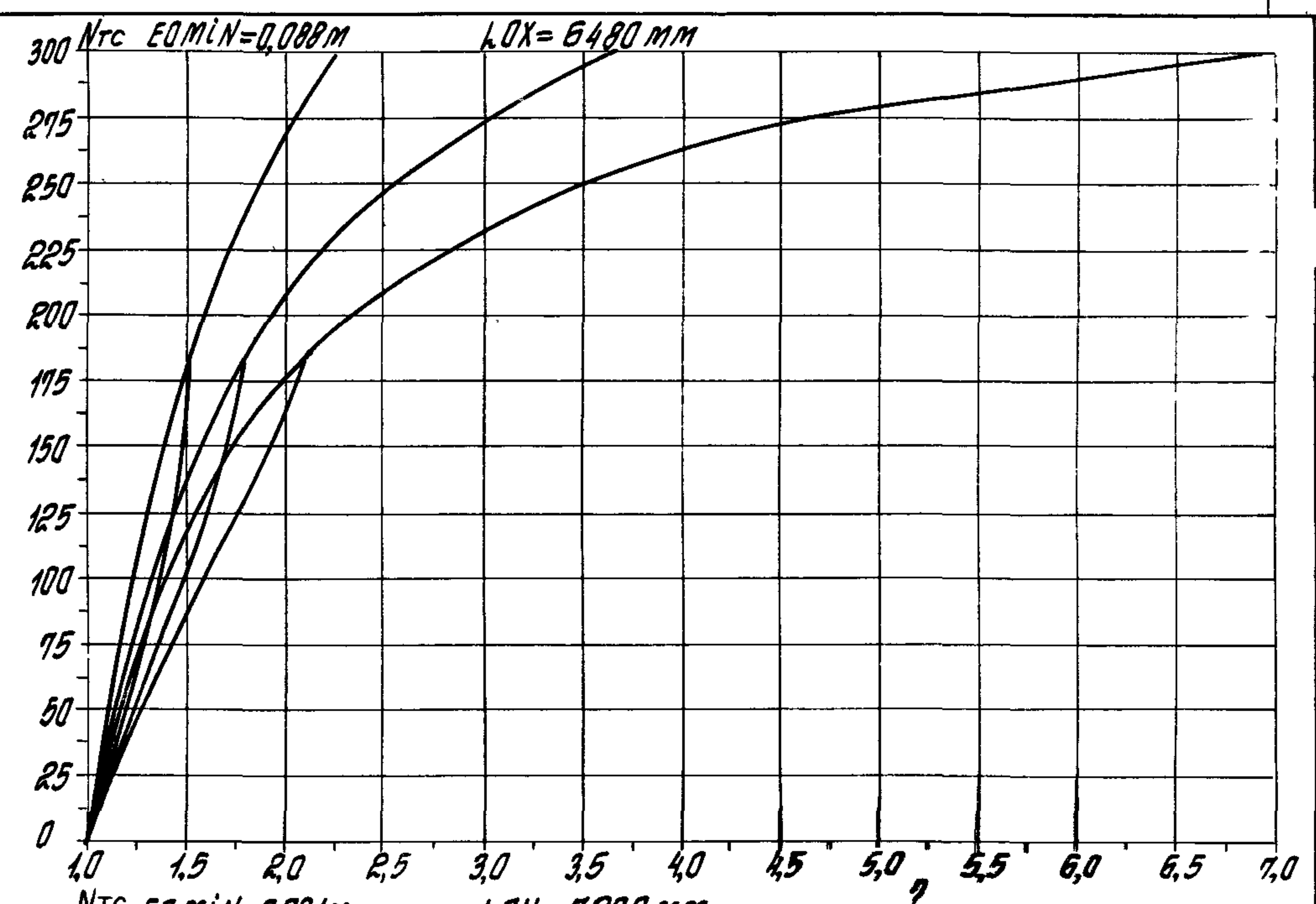
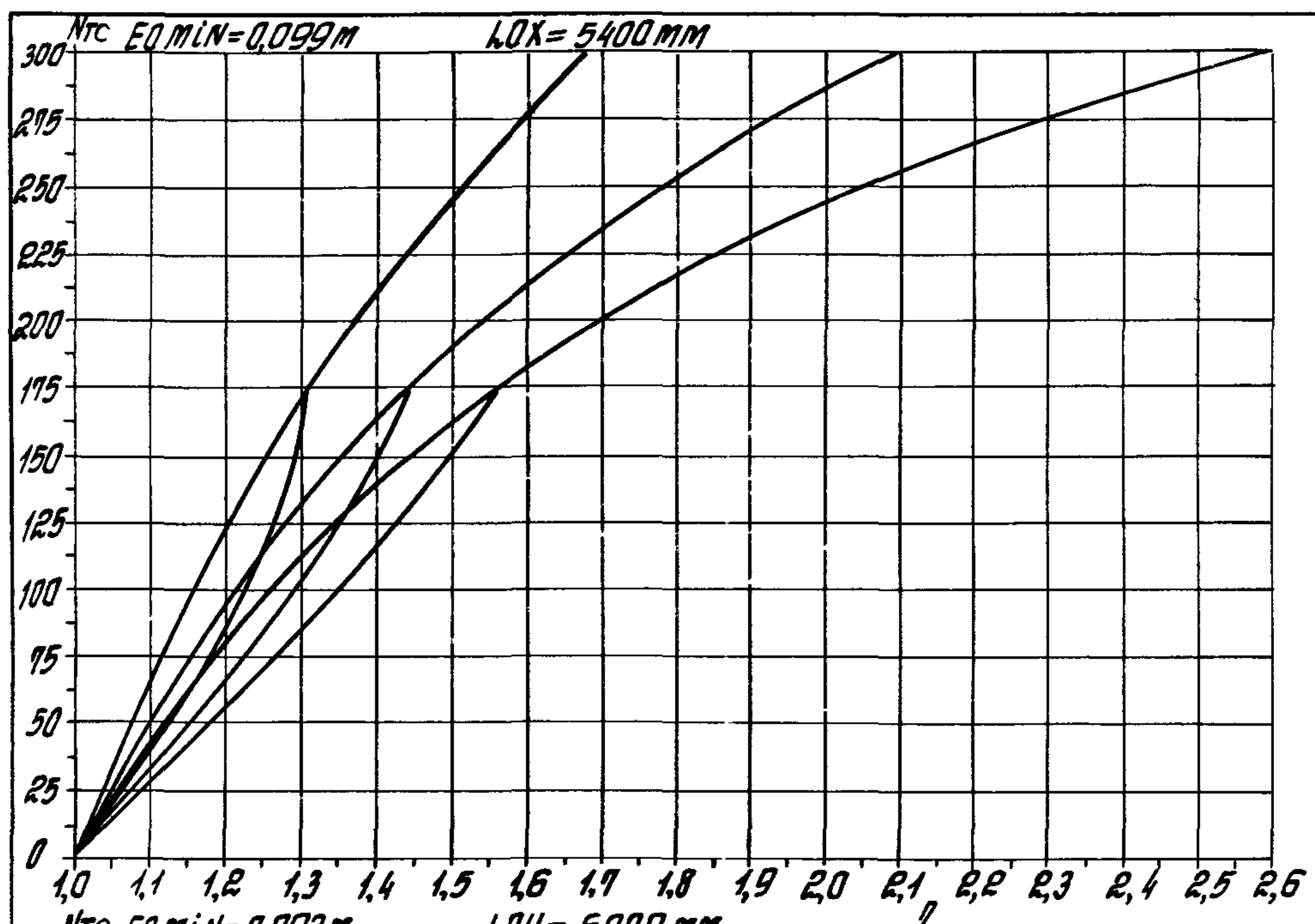

УДК № 700.01. Внутреннее сопротивление лампы № 1000-1000

1.020. 1-4 0-9 002

Июль 128

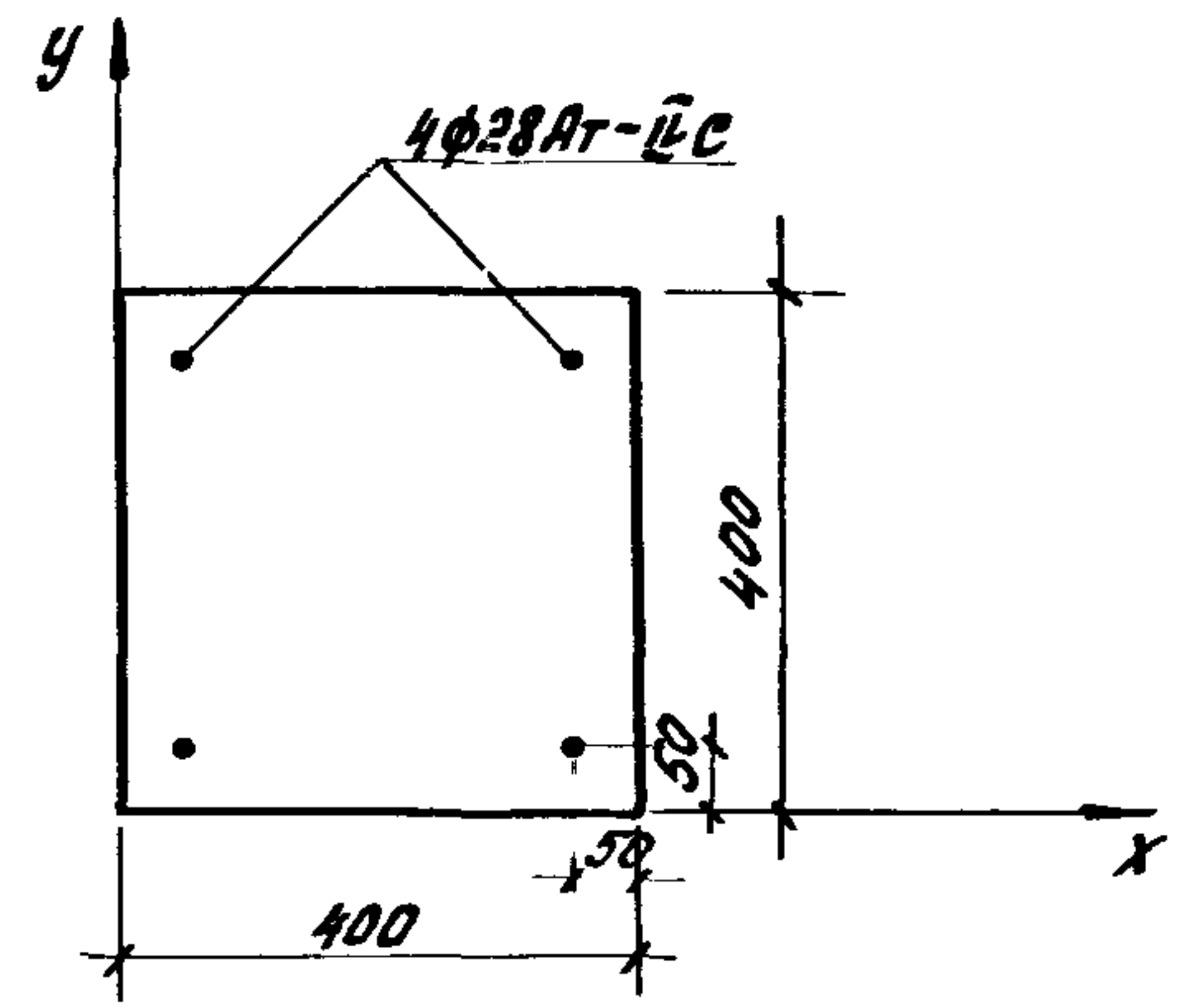
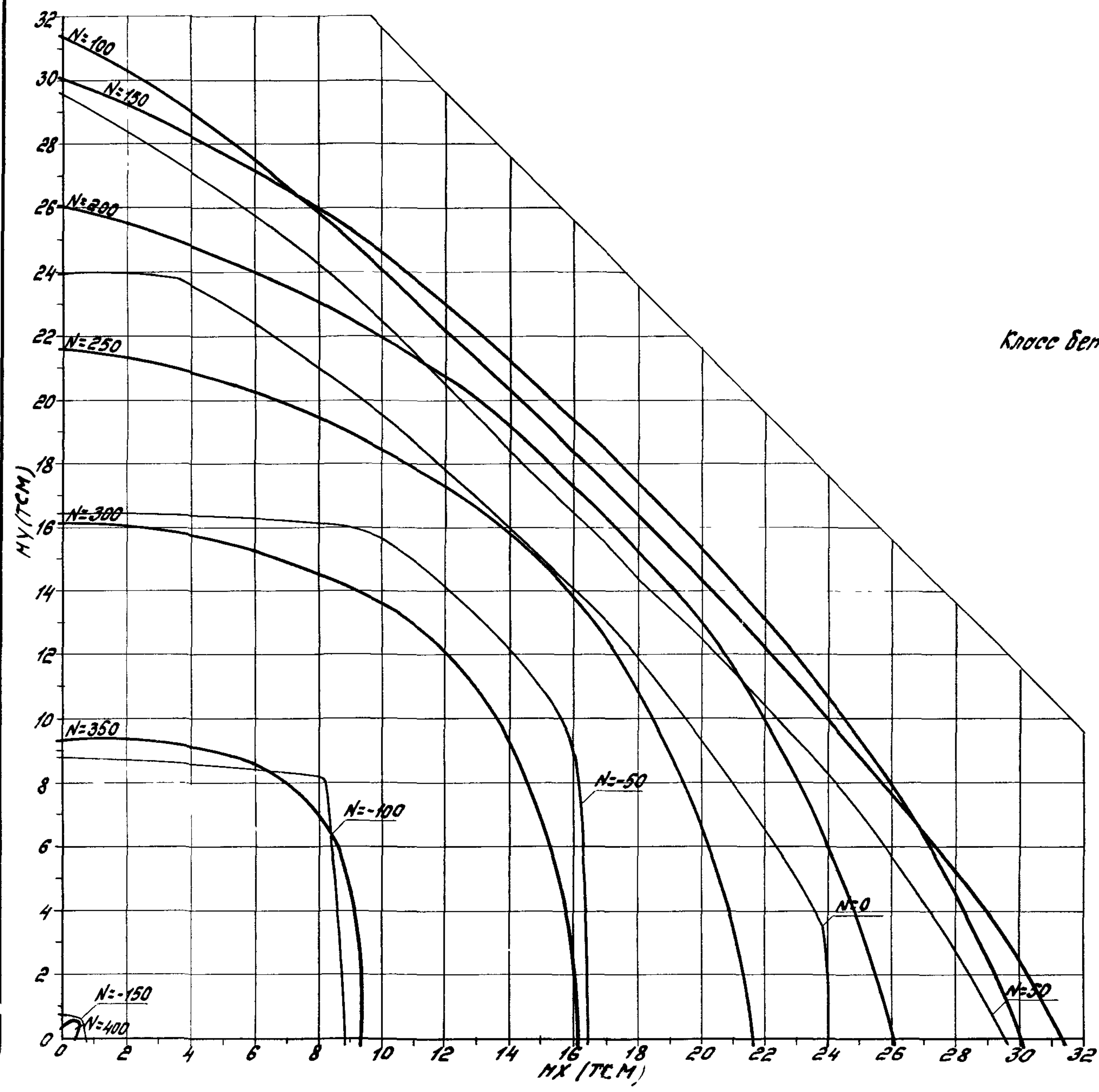

Класс бетона В30.0 ($R_s = 18.7 \text{ МПа}$ при учёте $\gamma_{c2} = 1.10$)
 Сталь Ат-ІІС
 Код сечения - 117а

1.020. 1-4 0-9 002

Лист
129

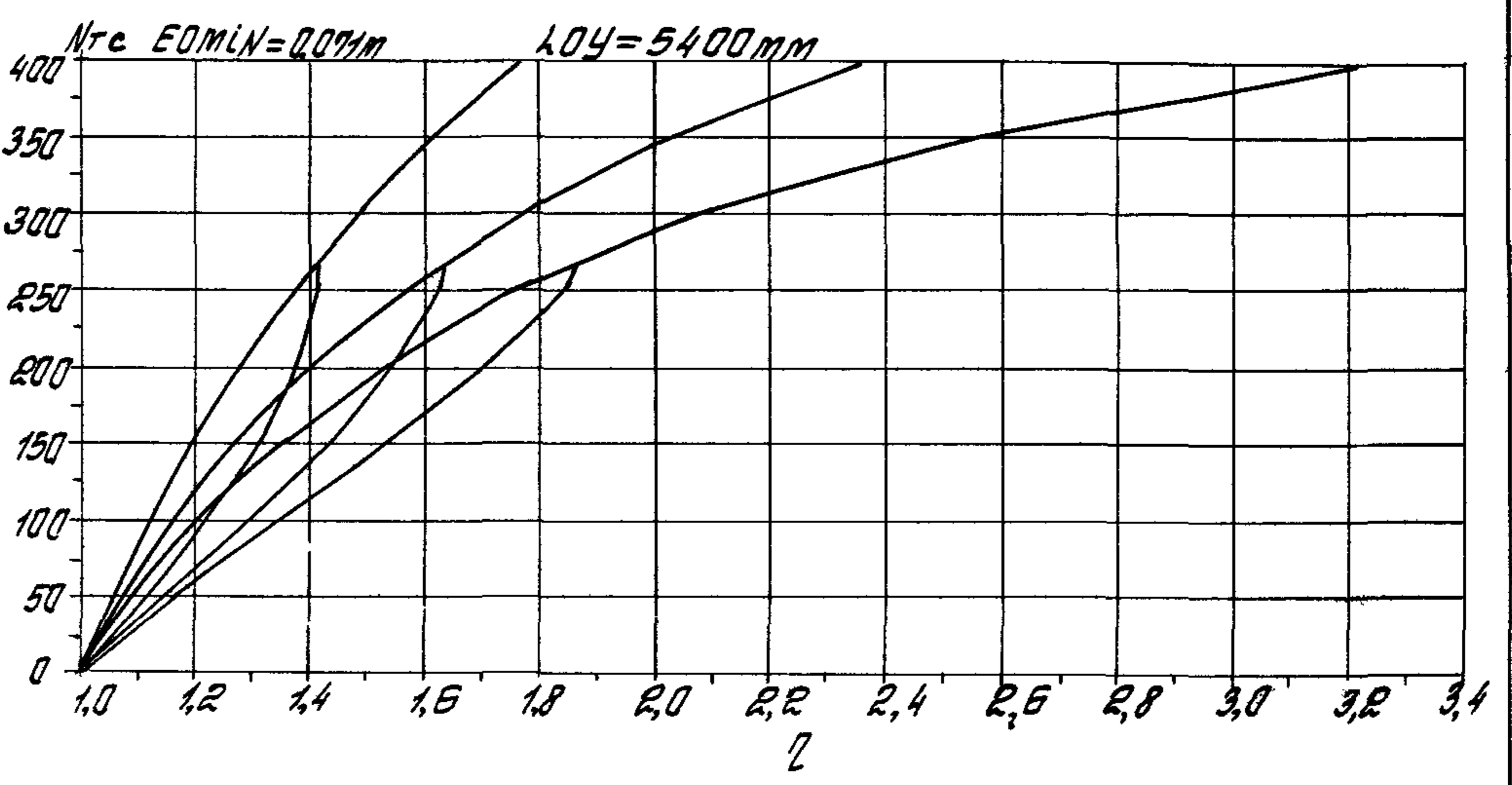
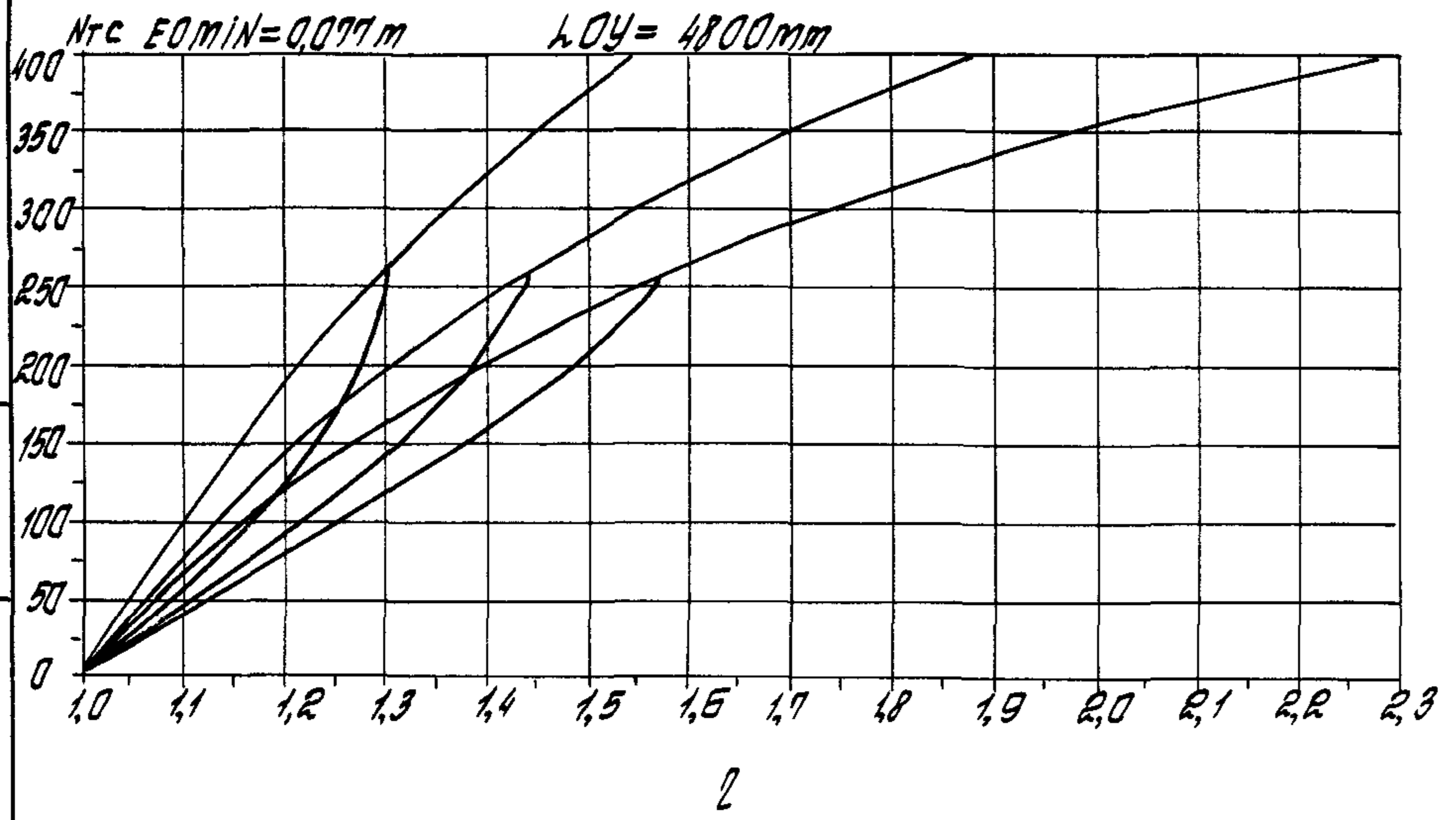
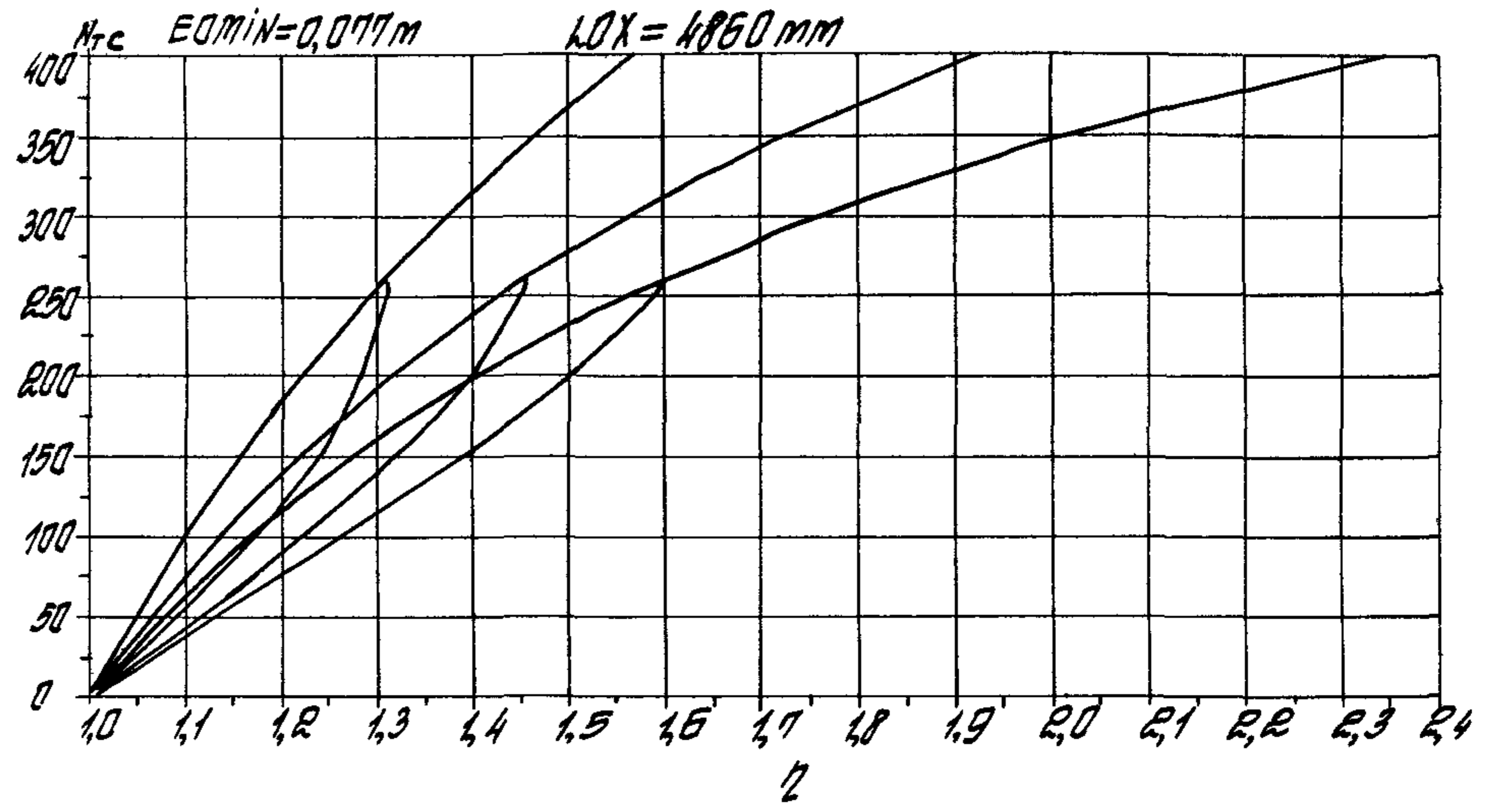
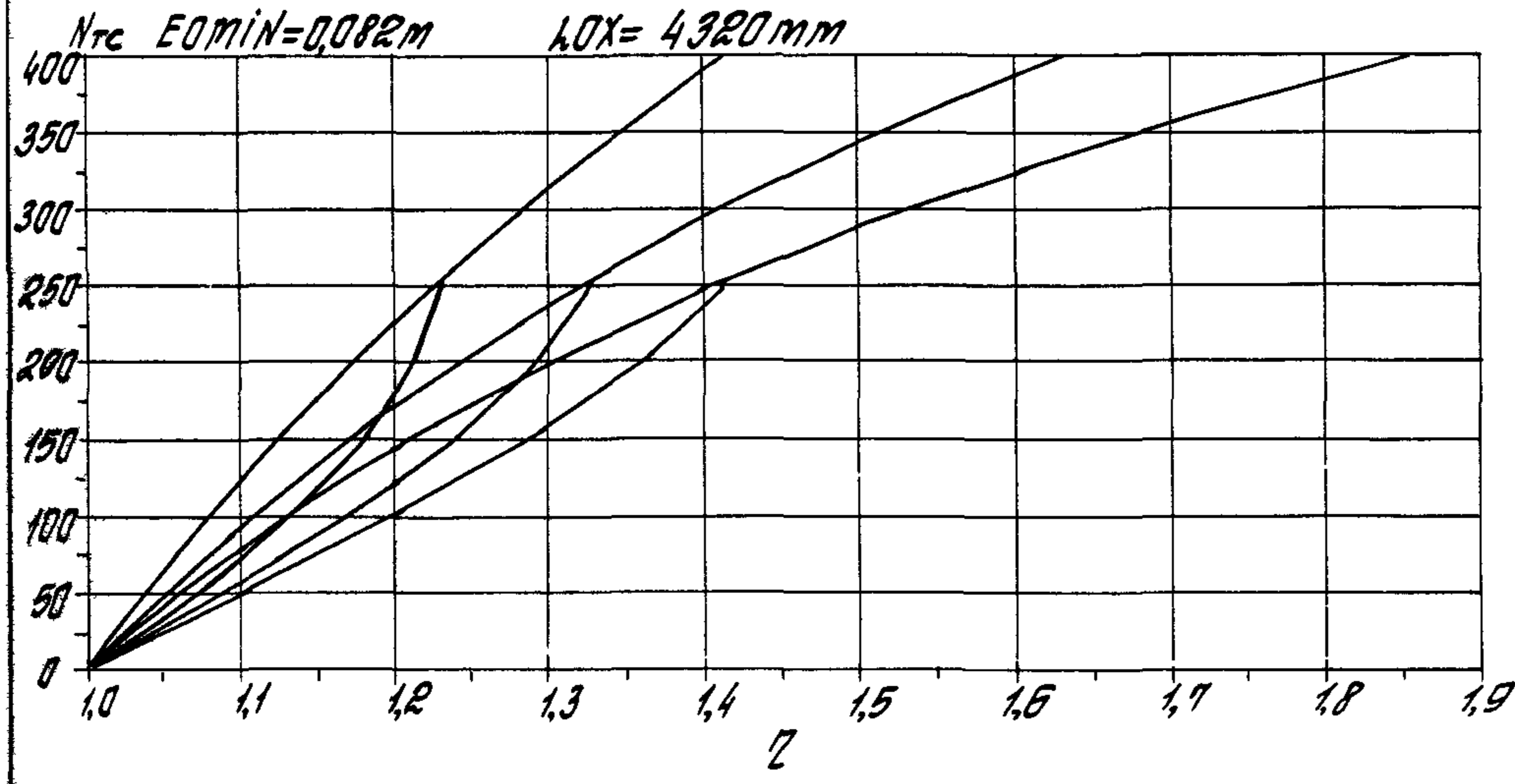

Шкала № 1000. Показывает в мм.

1.020.1-4 0-9 002 Итем
131

4φ 28Aт-IVс

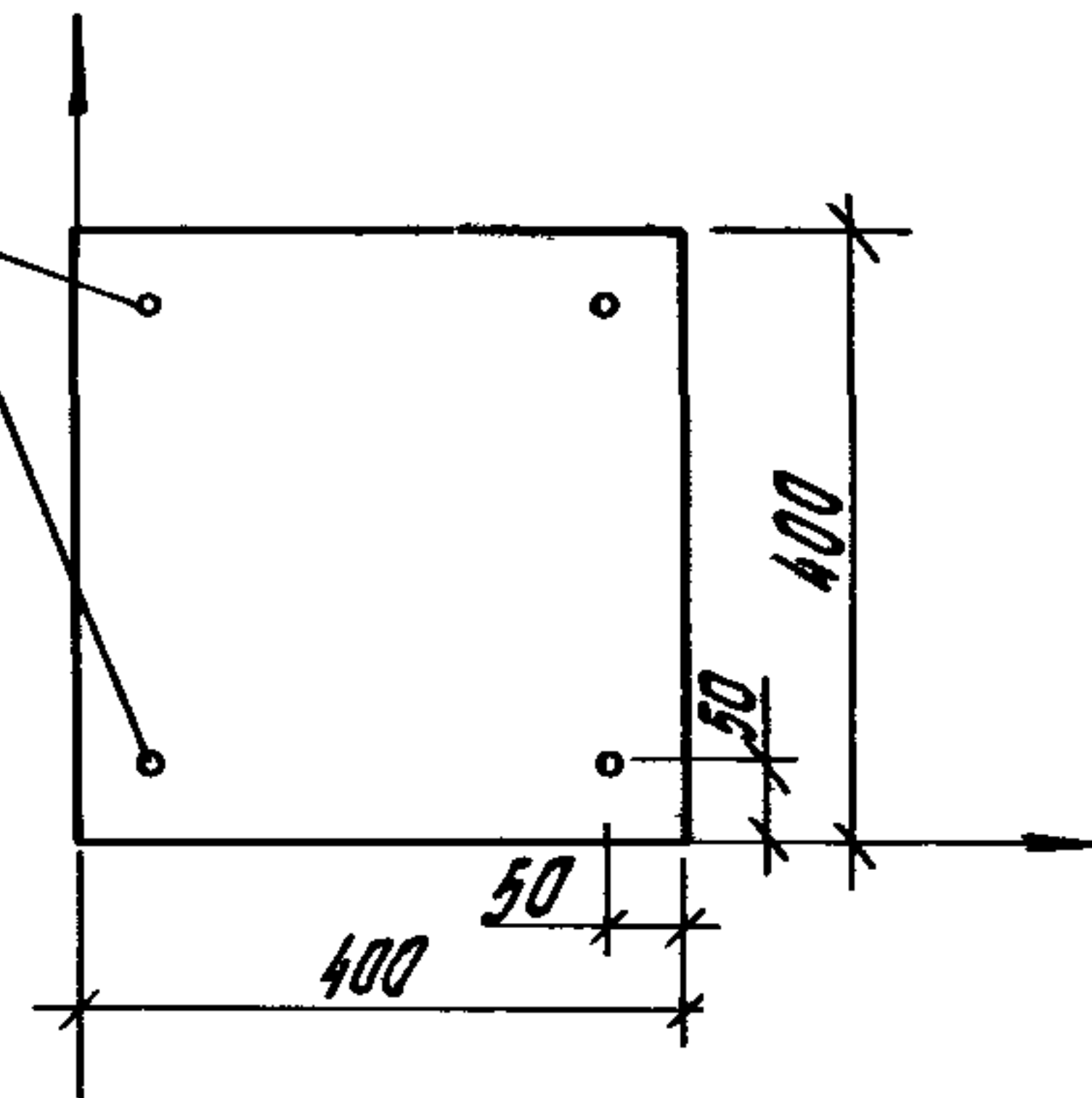

Класс бетона В 30,0 ($R_b = 15,3 \text{ МПа}$ при учете $\chi_{R2} = 0,90$)
 Сталь Ат-IVс
 Код сечения - 117б

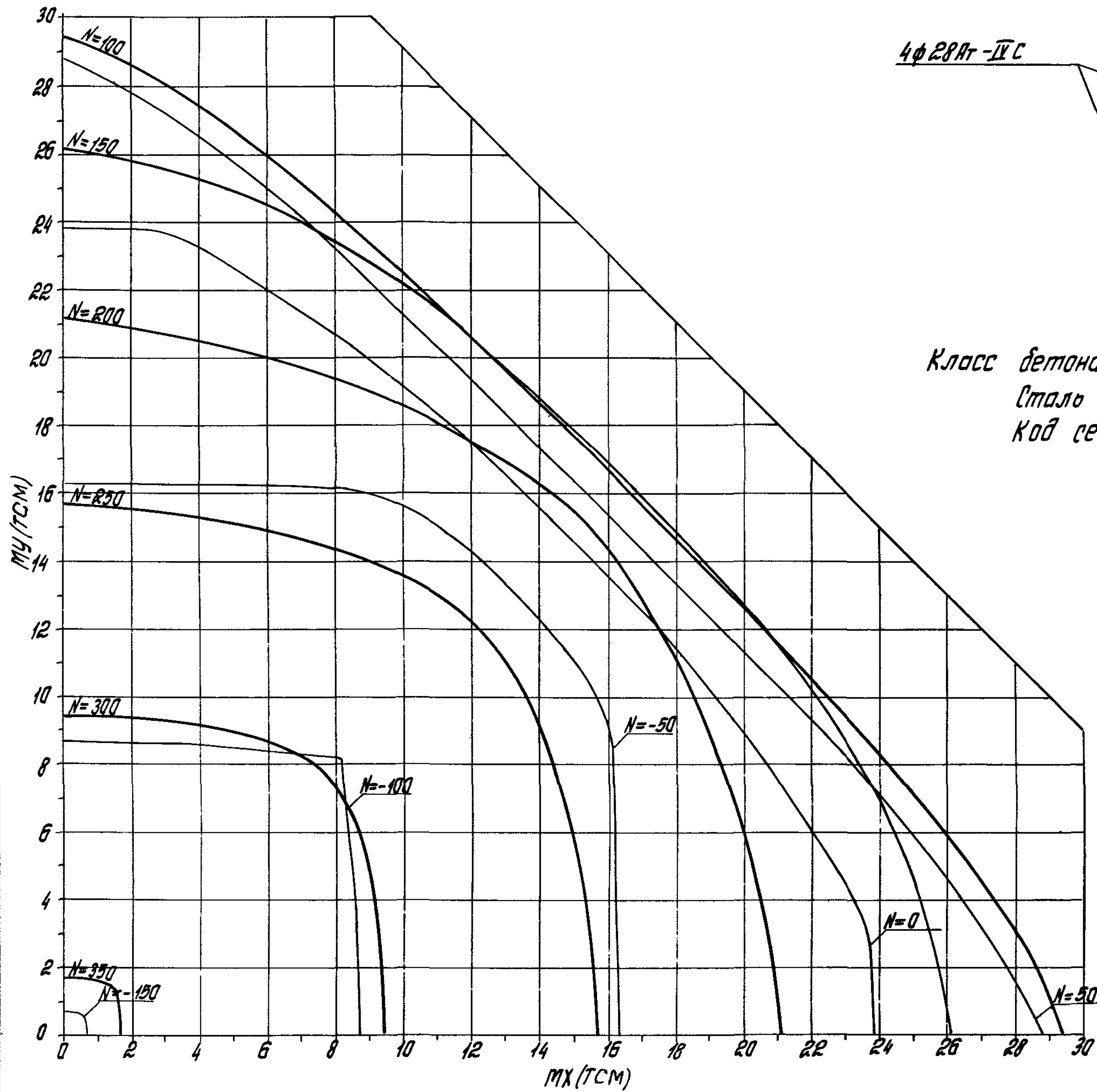

1.020.1-4 0-9 002
 138

1.020.1-4 0-9 002 138

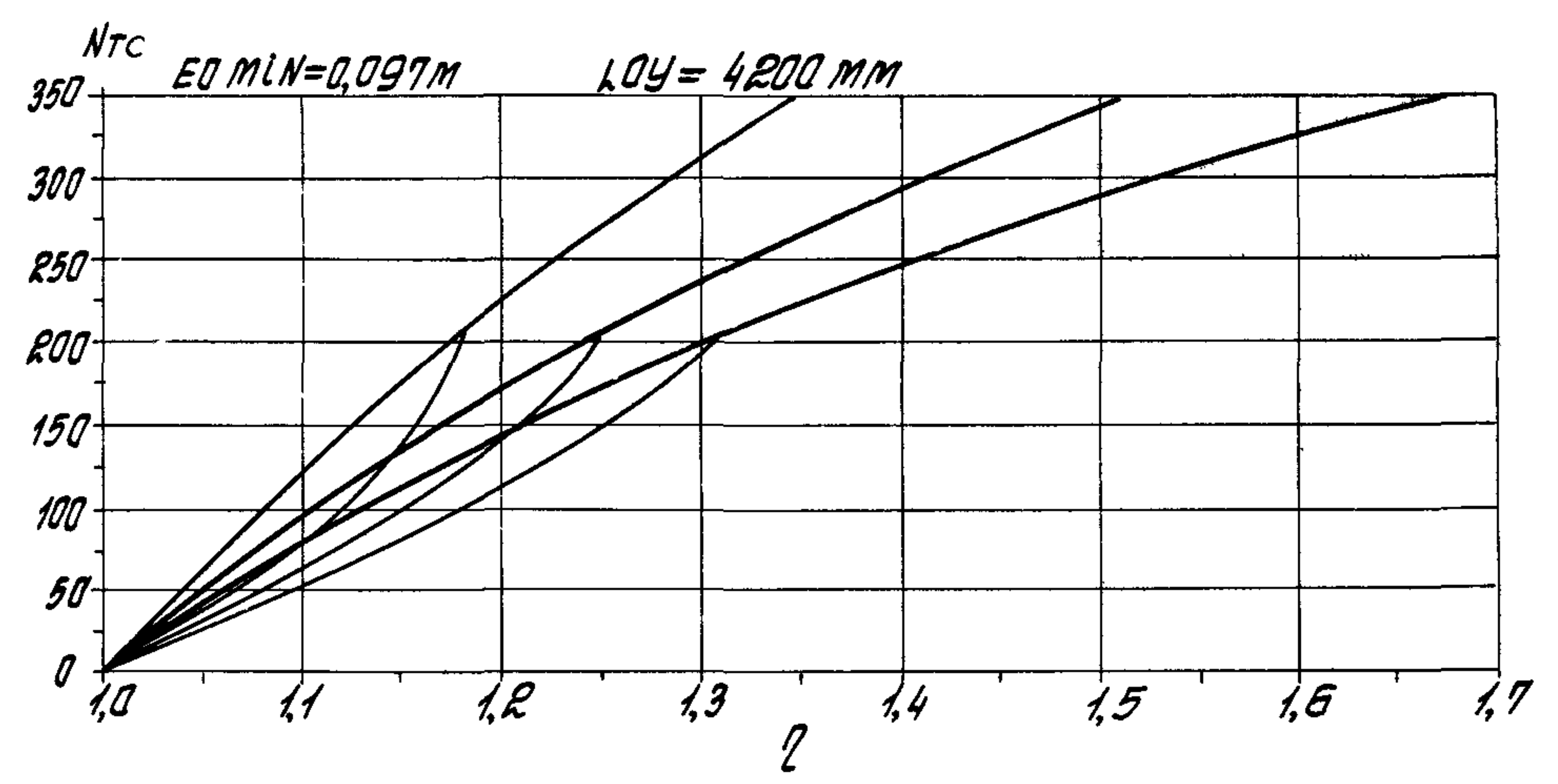
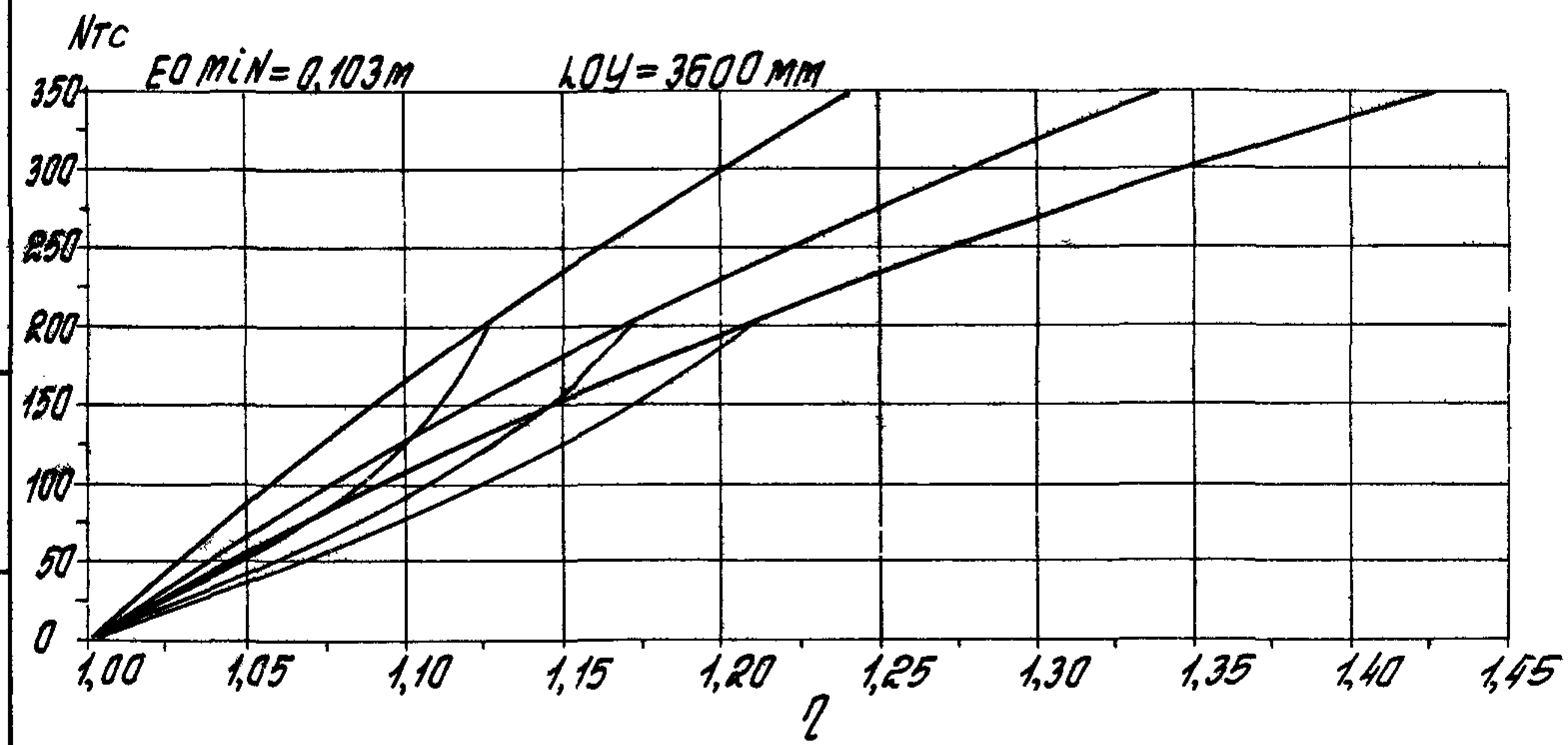
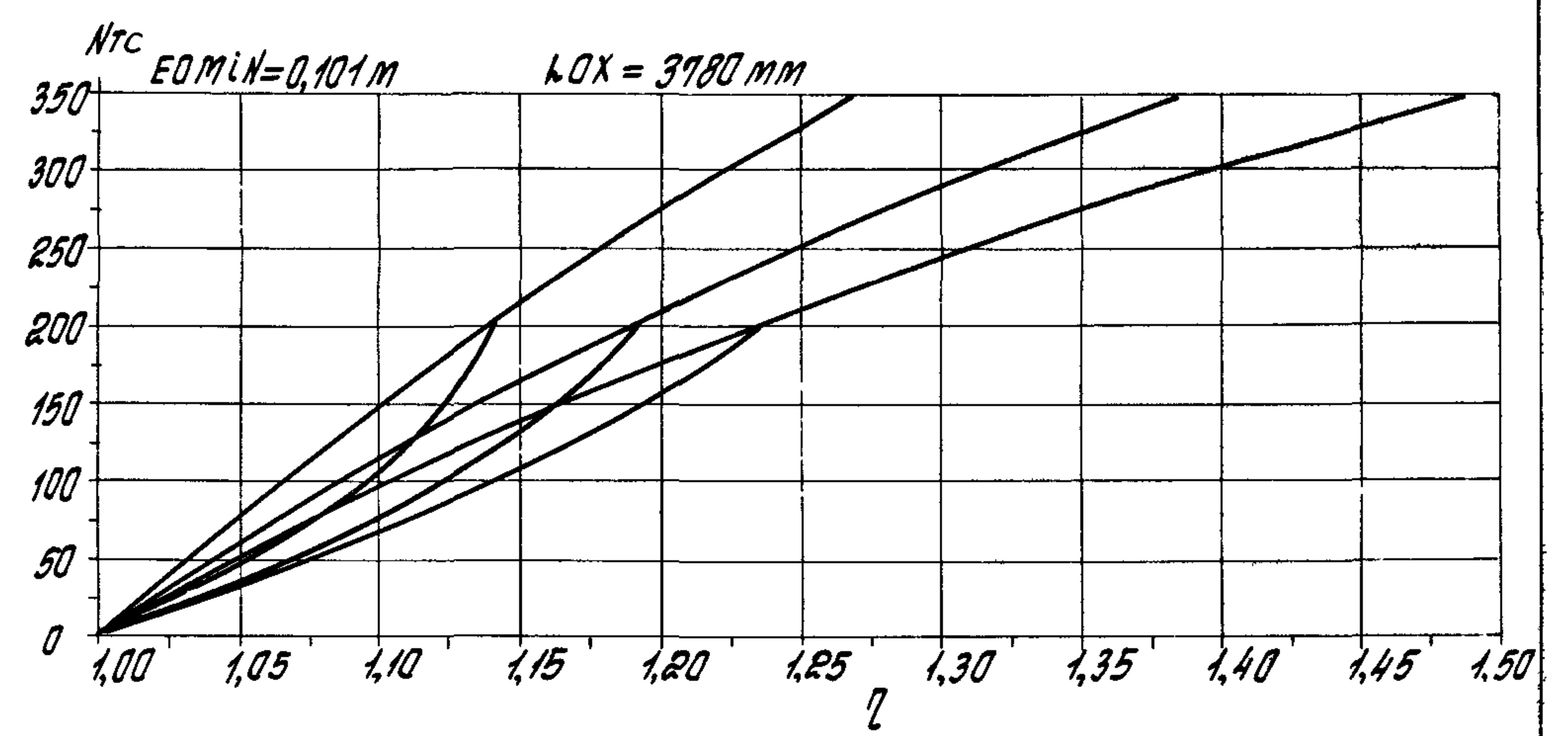
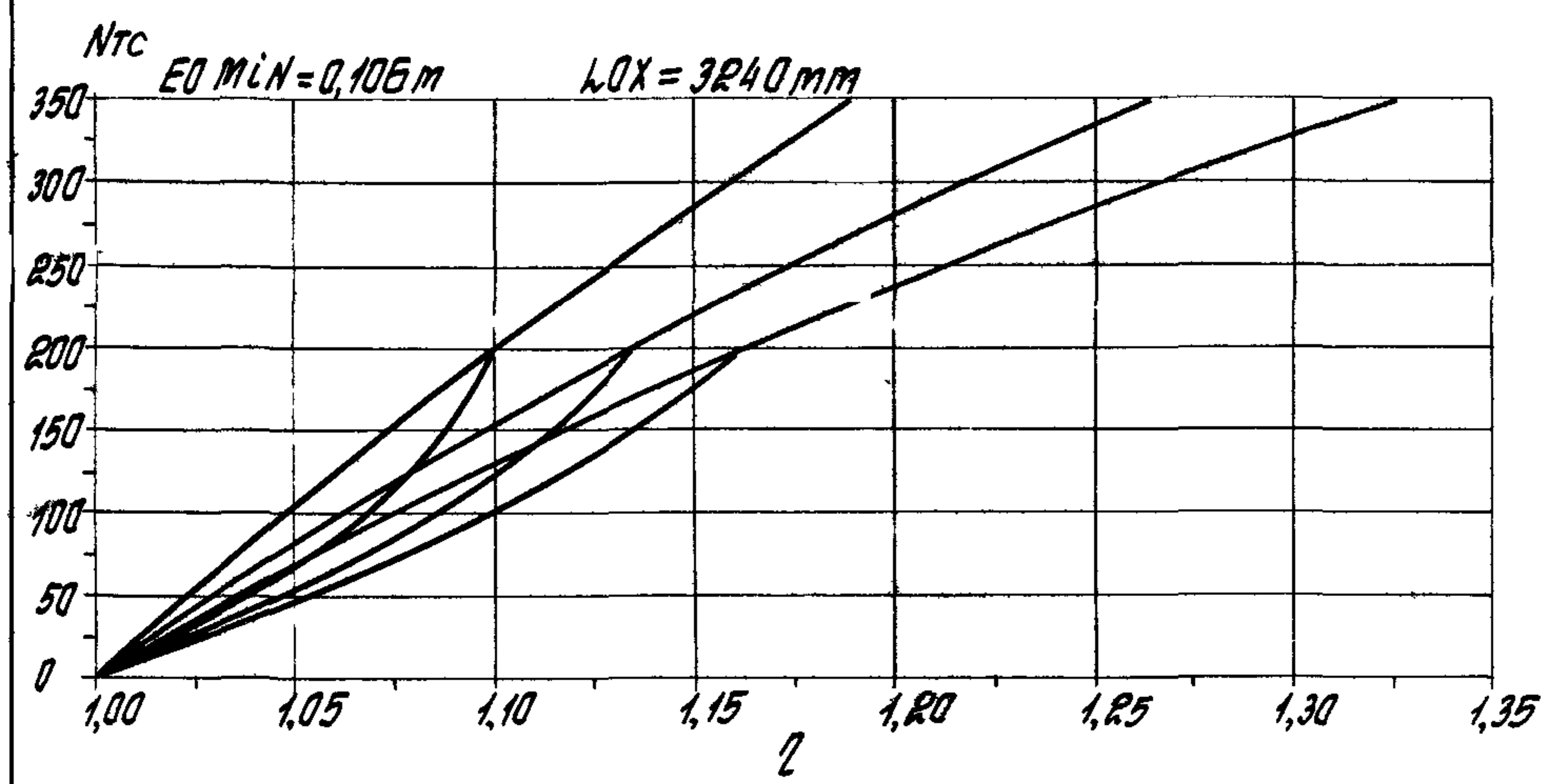

1.020.1-4 D-9 002
 134

1.020.1-4 D-9 002

Docm
134

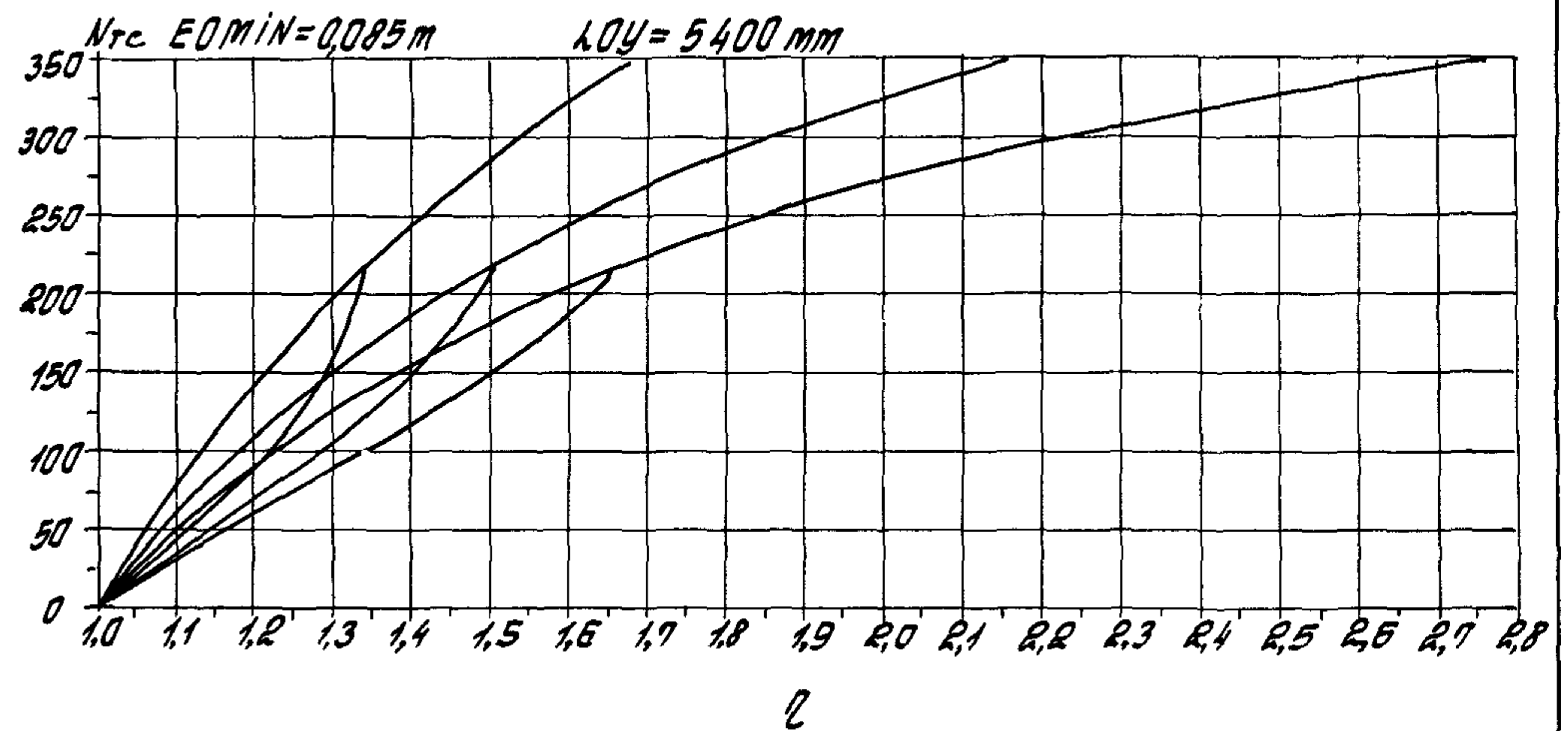
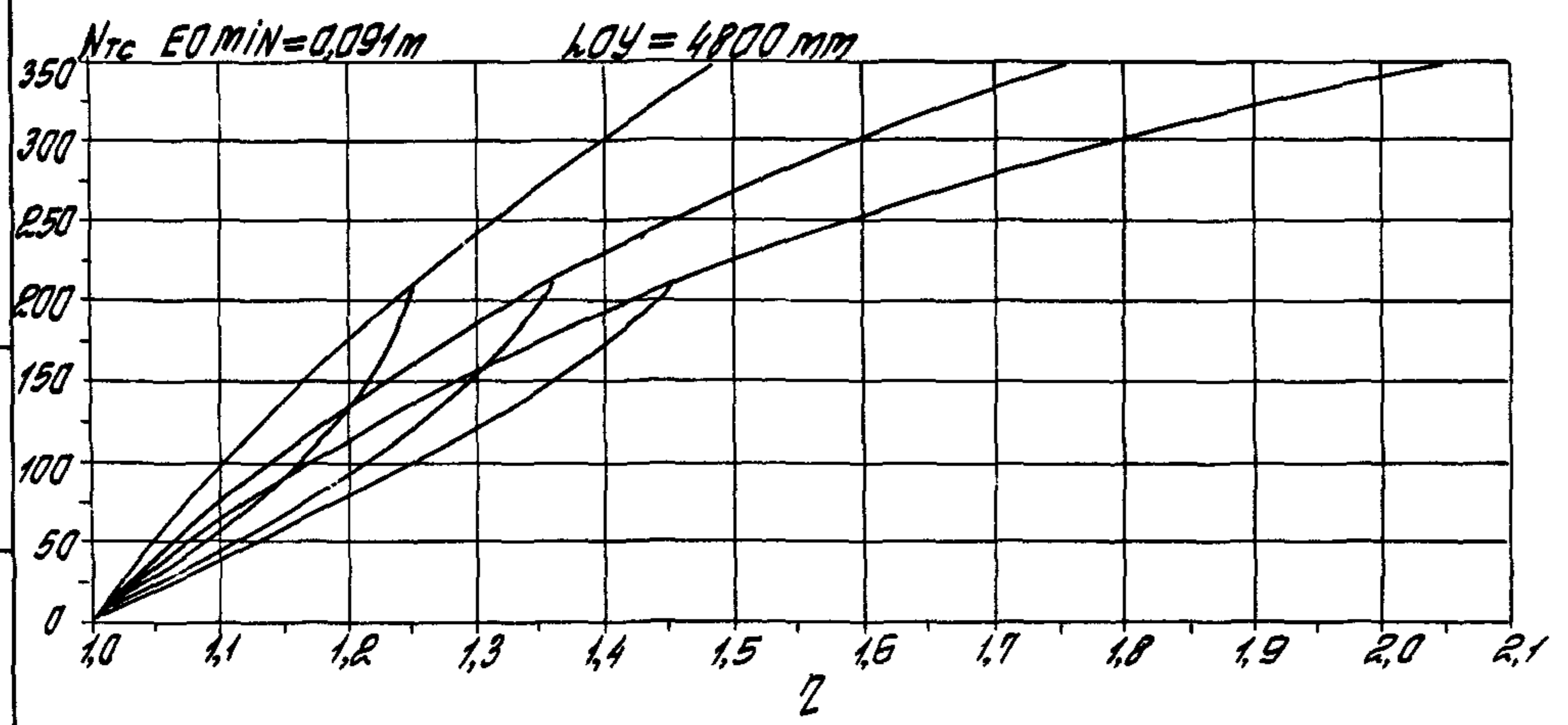
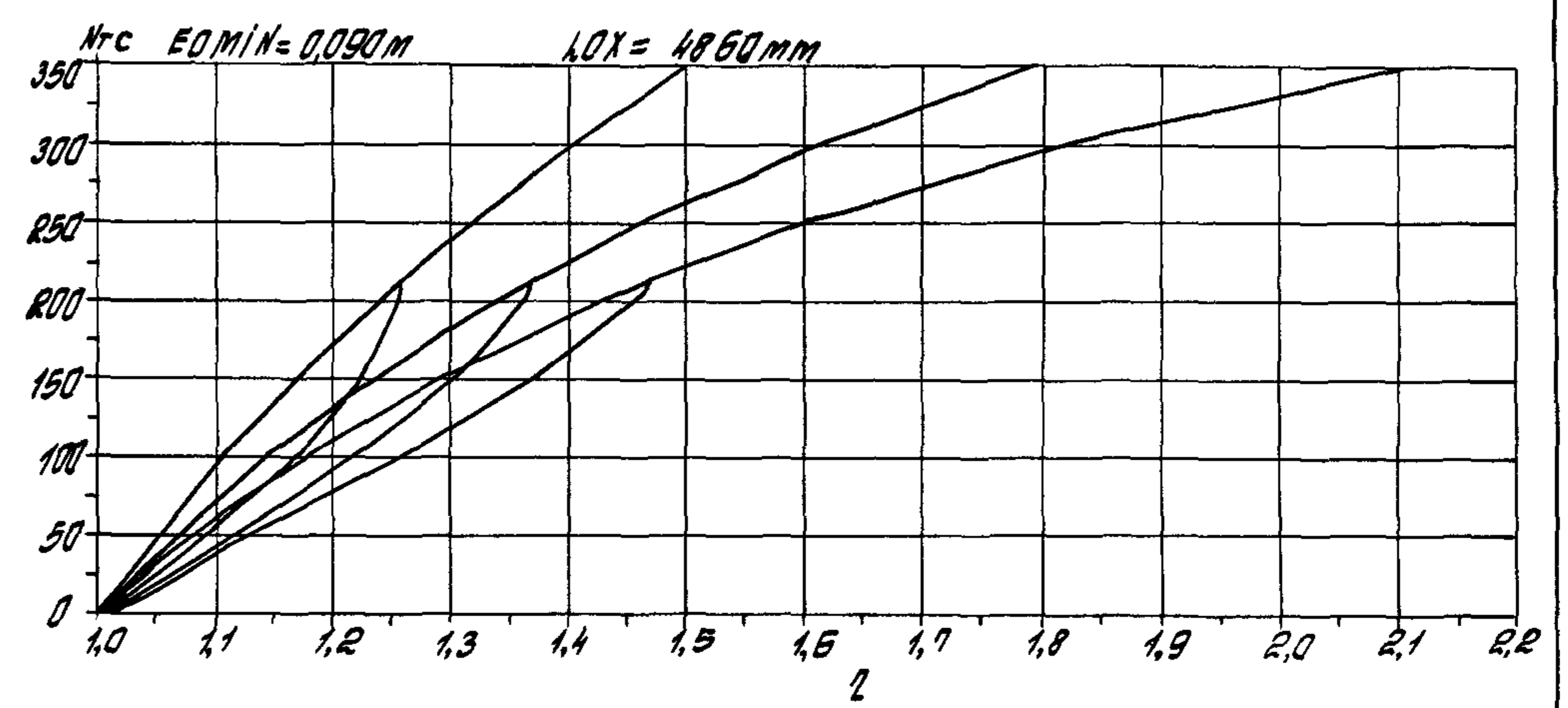
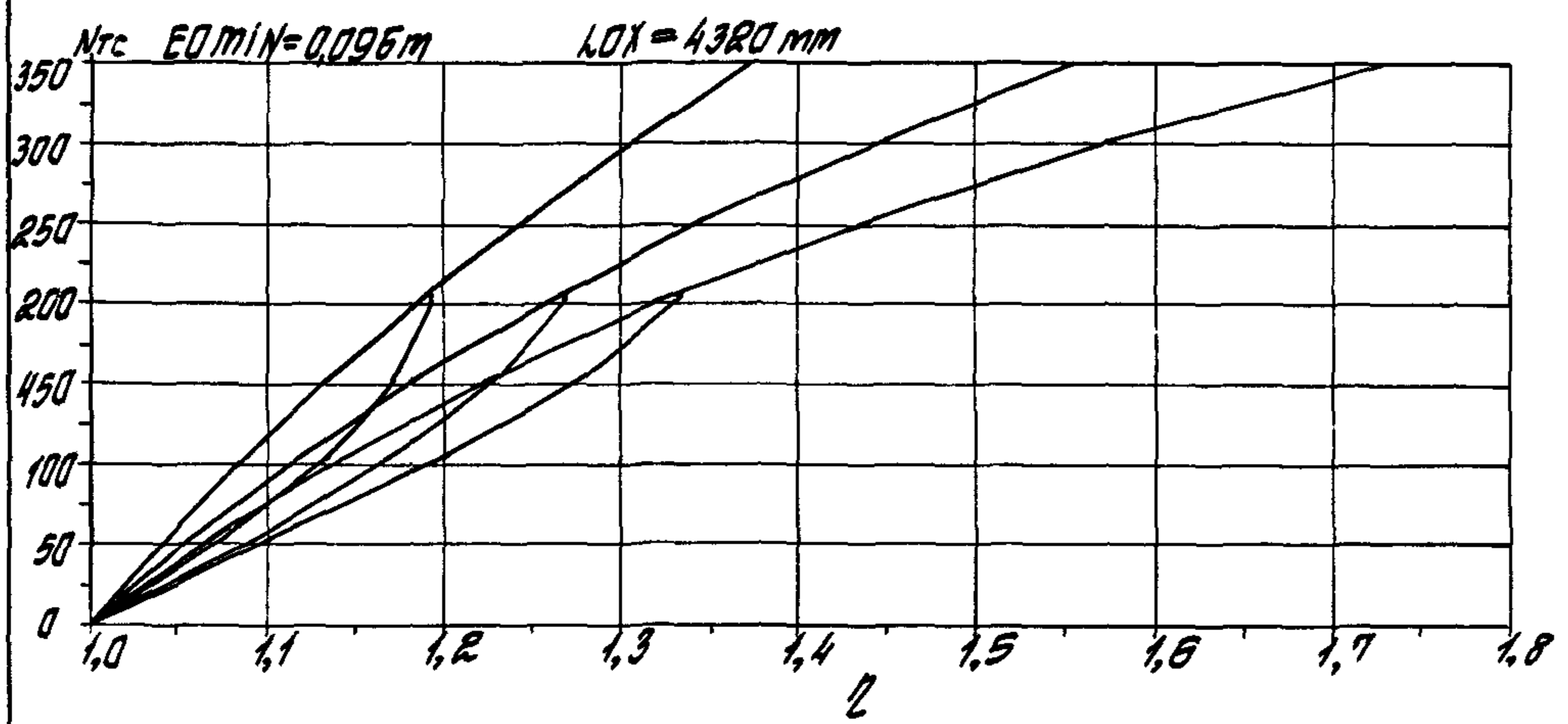

Личн. ... да. Подпис. и дата. Заам. инб. №

1.020.1-4 0-9 002			Личн
			135

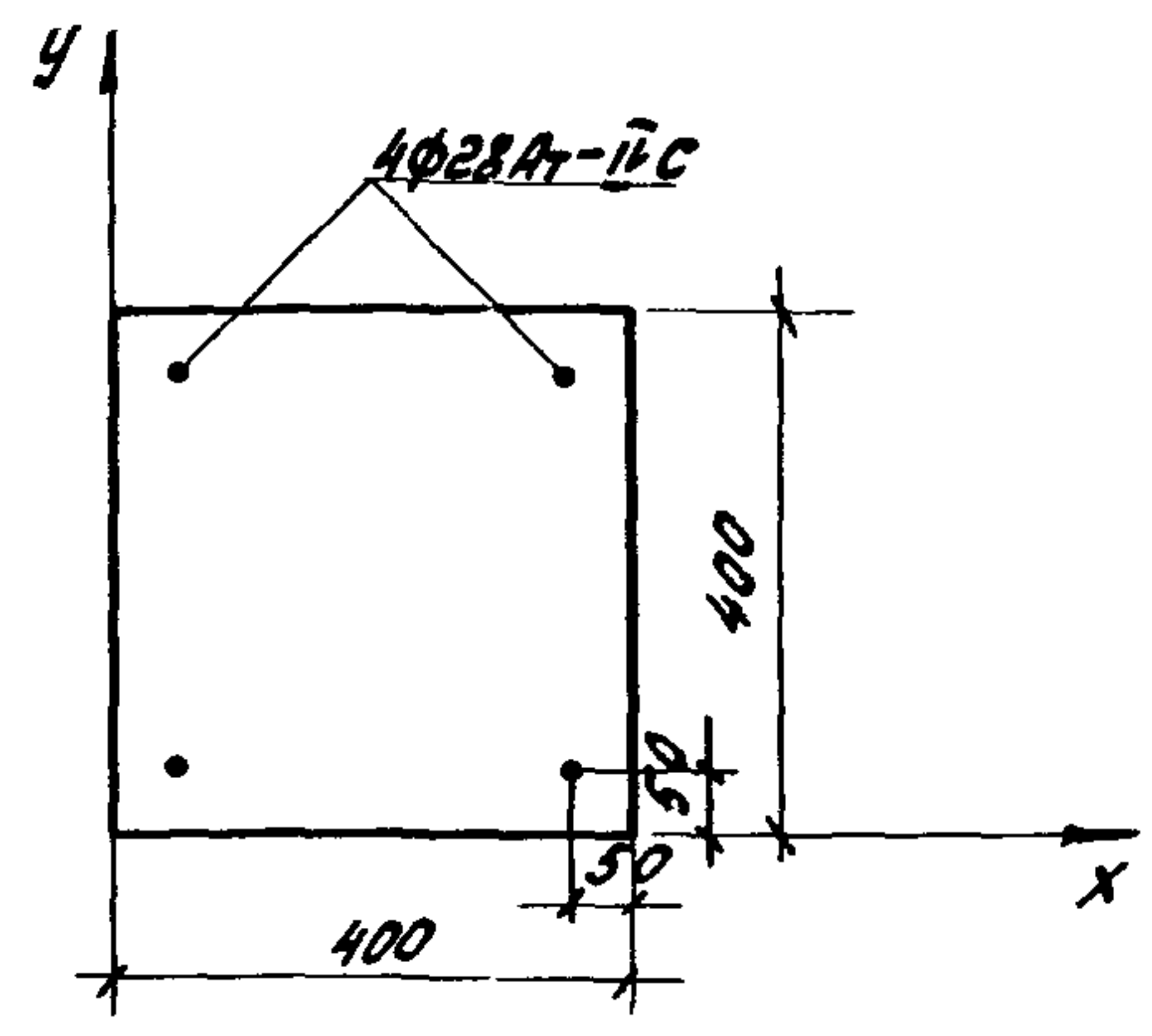
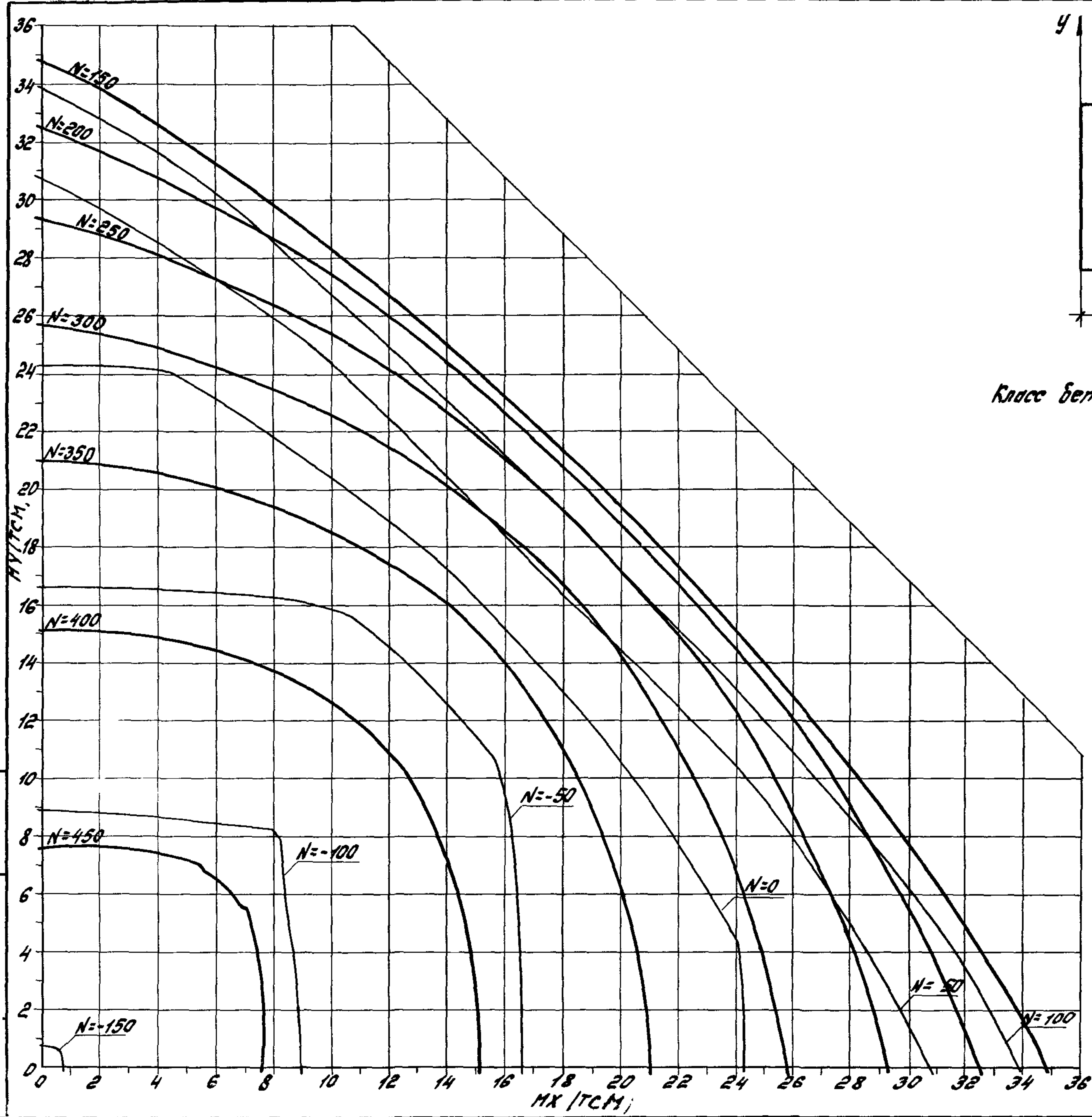

Класс бетона В40.0 ($R_b = 24.2 \text{ МПа}$ при учёте $\gamma_{b2} = 1.10$)
 Сталь Ат-ІІС
 Код сечения - 118 а

Упр. № 1000

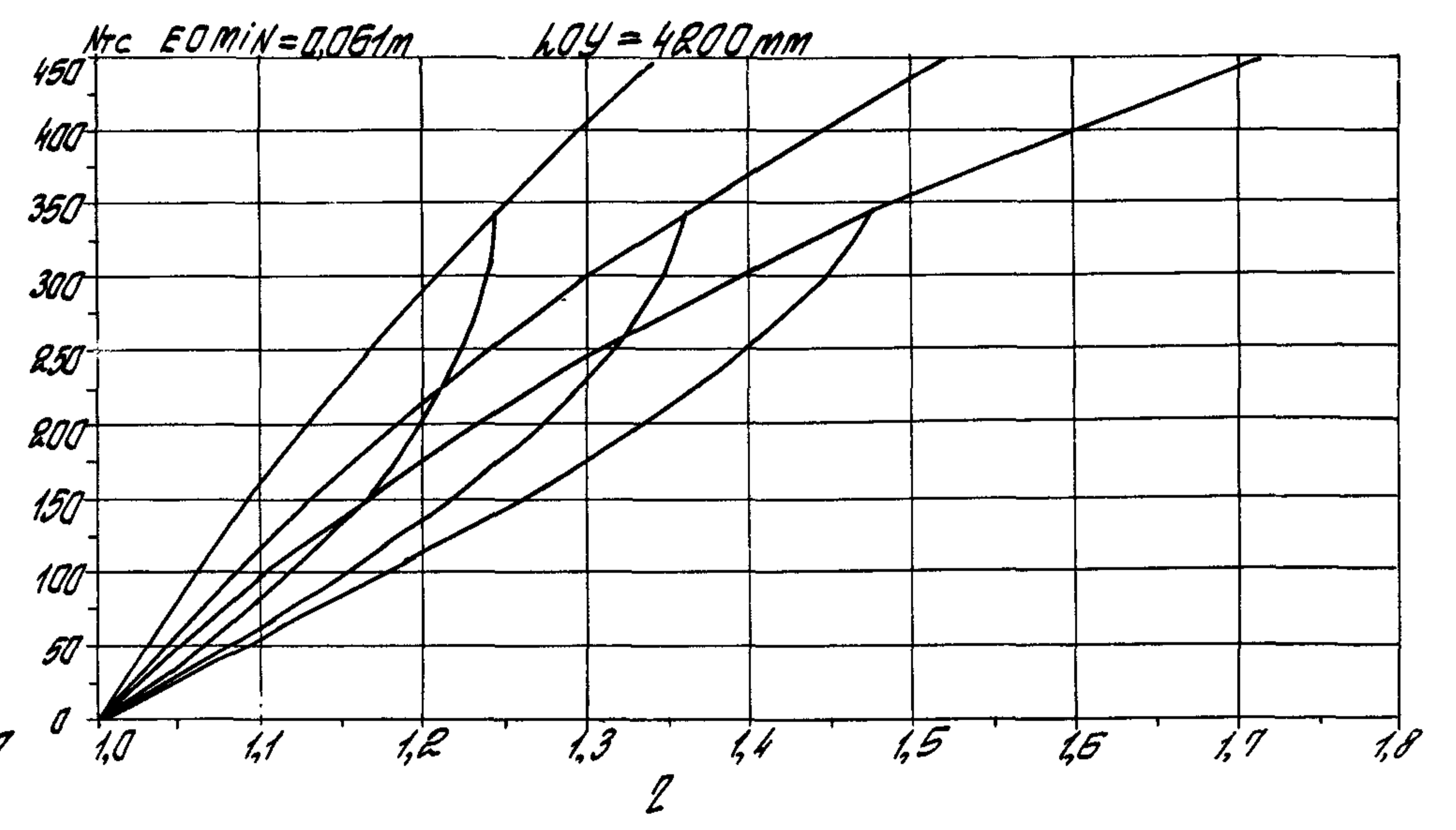
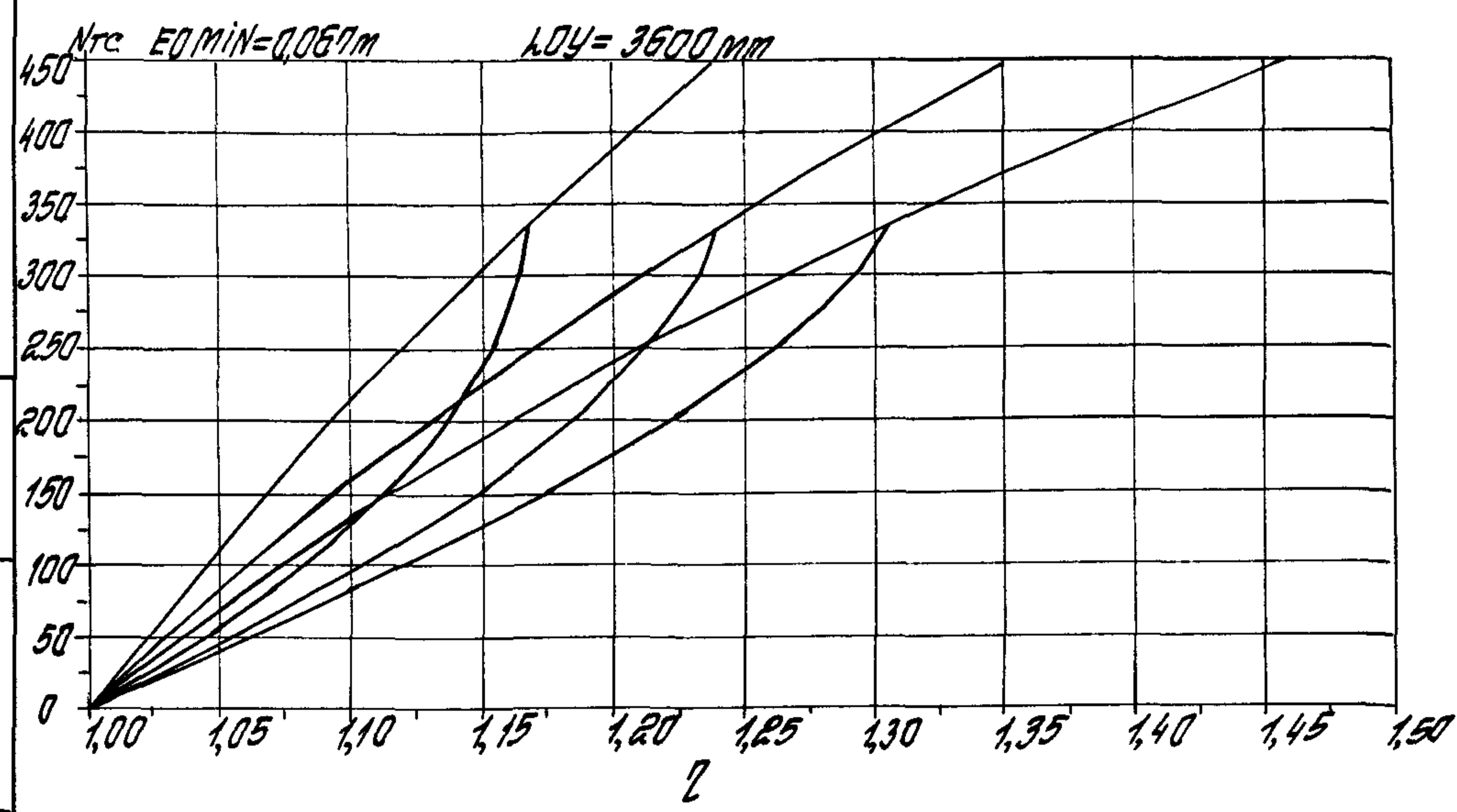
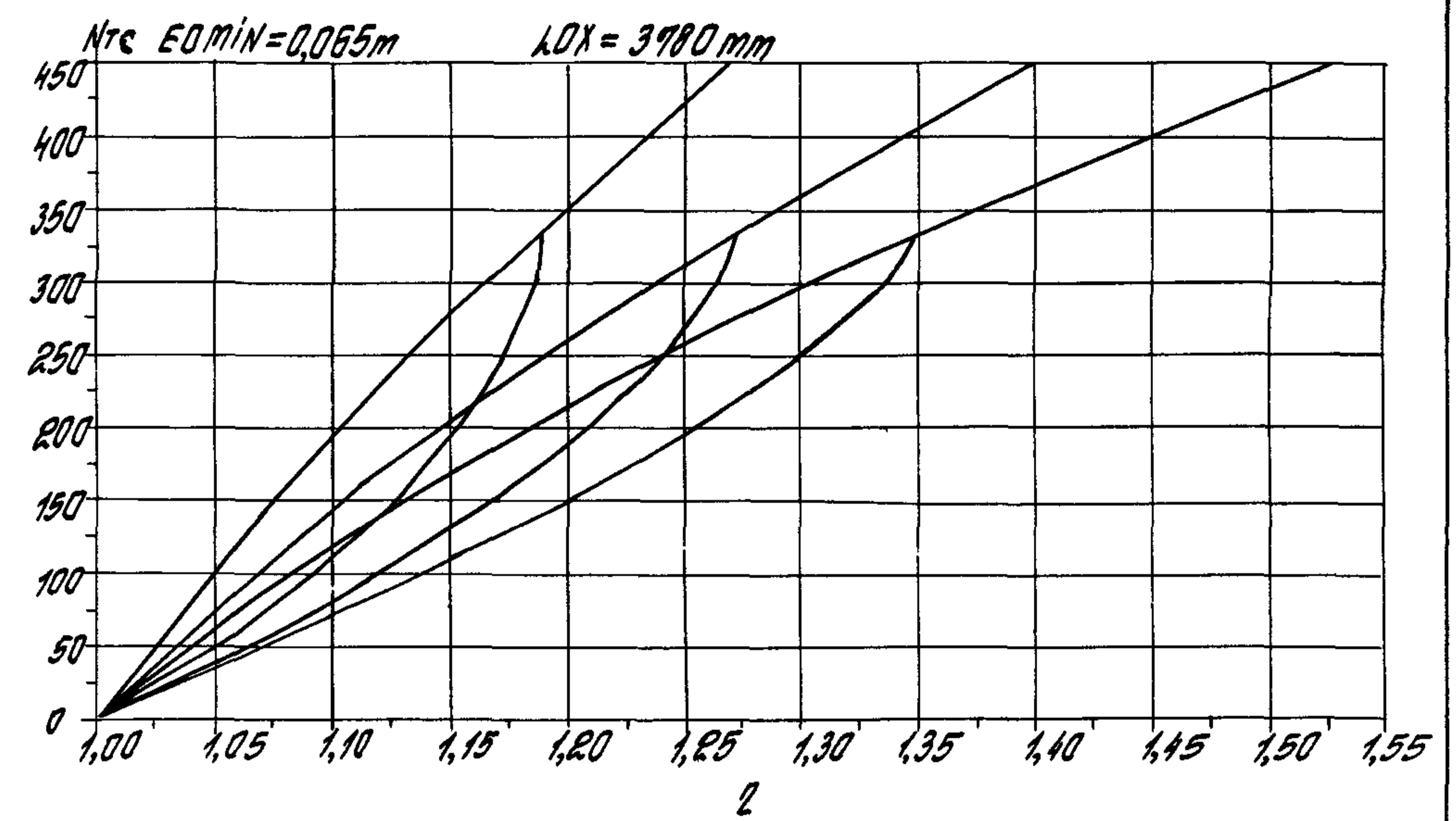
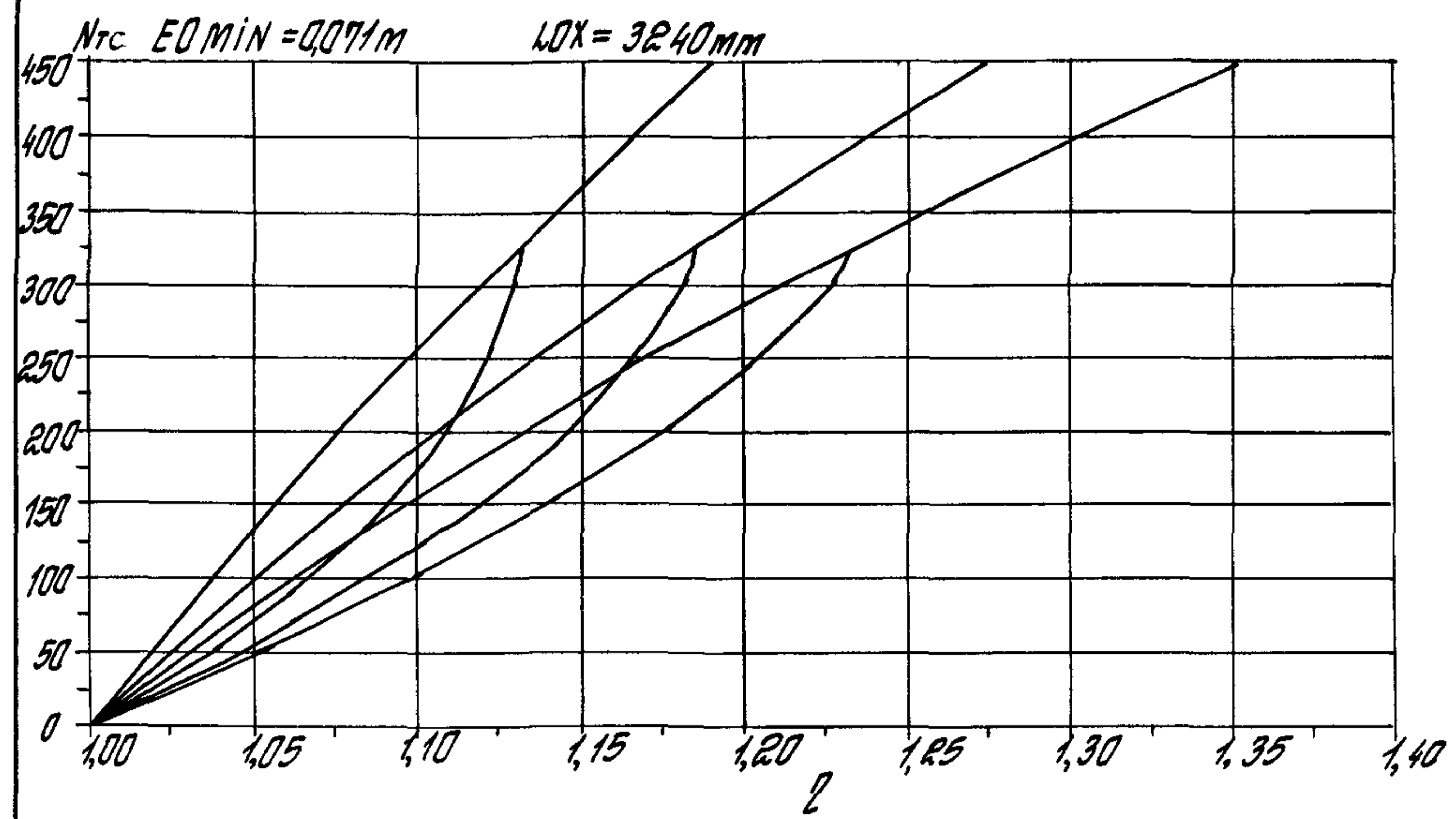

Инв. № подл. Подпись и дата. Взам. инв. №

1.020.1-4 0-9 002

Лист 138

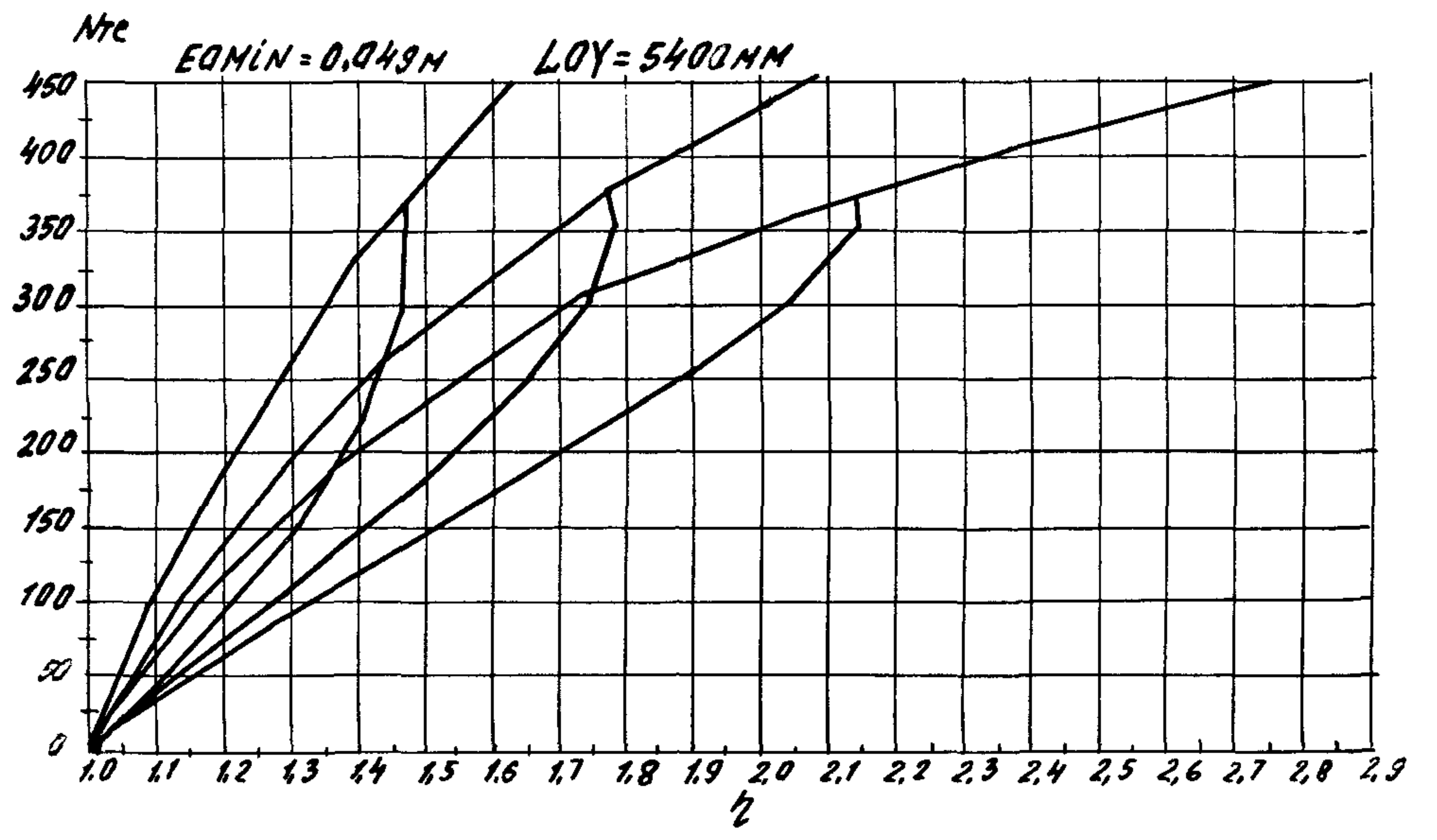
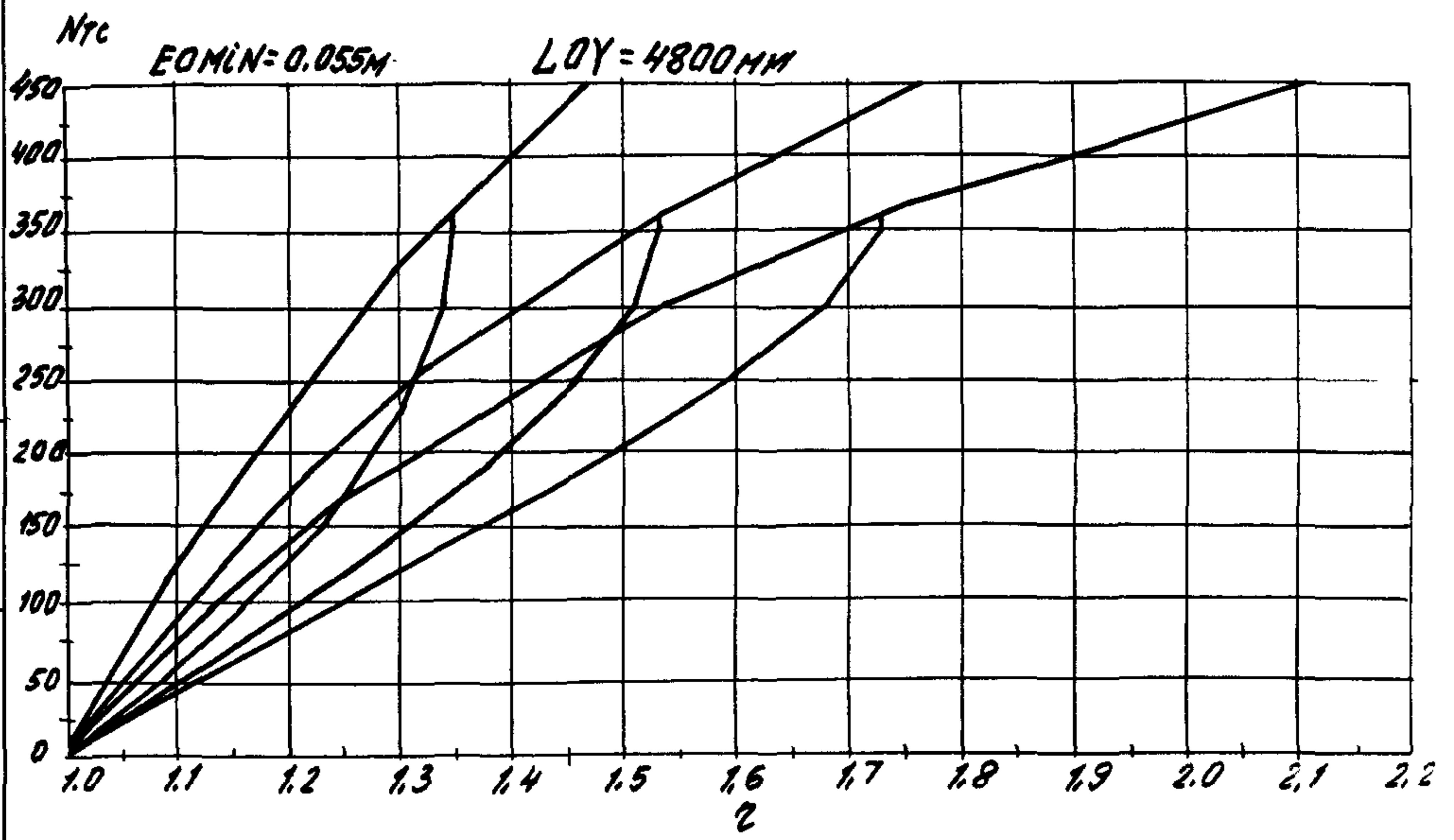
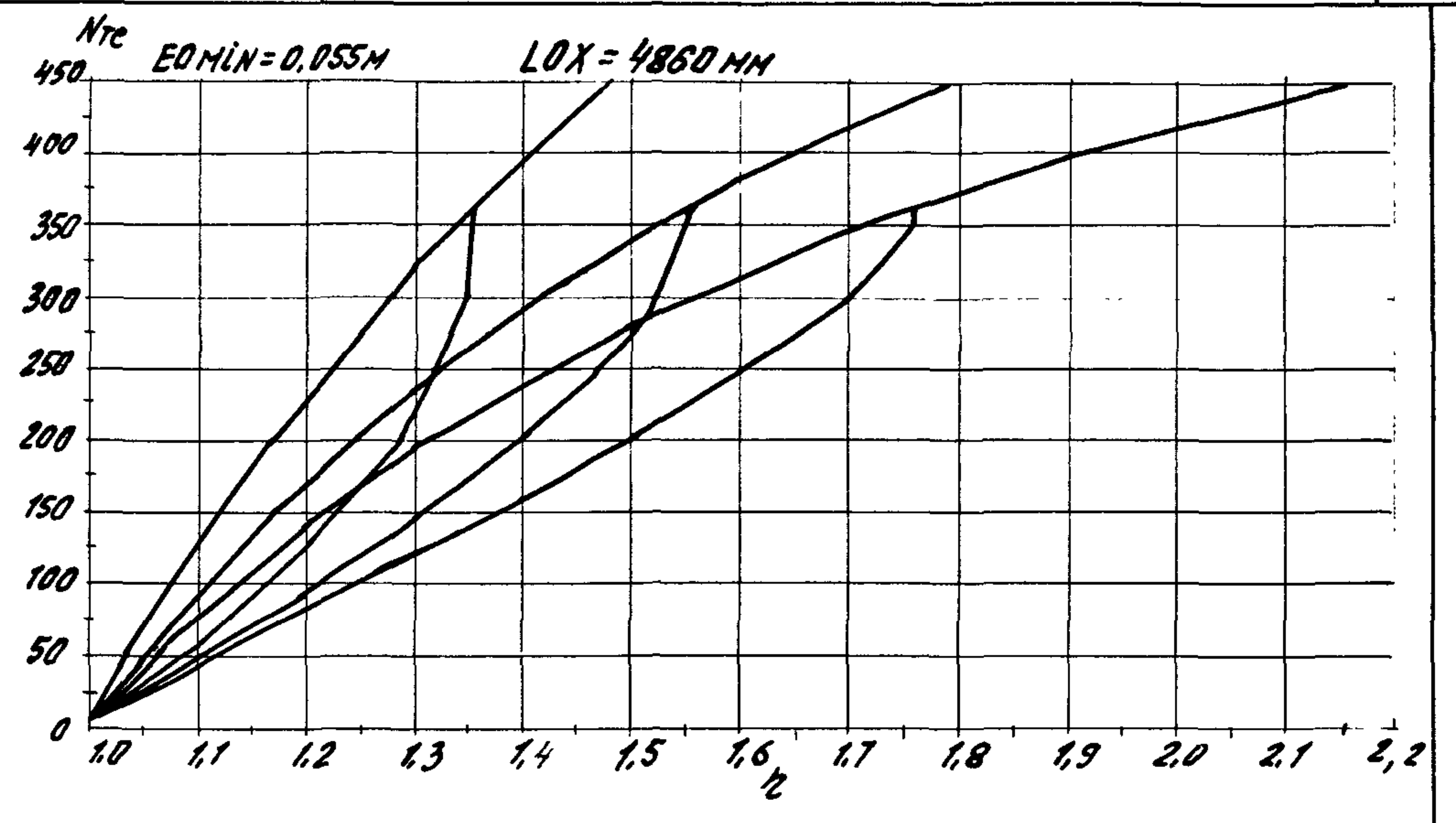
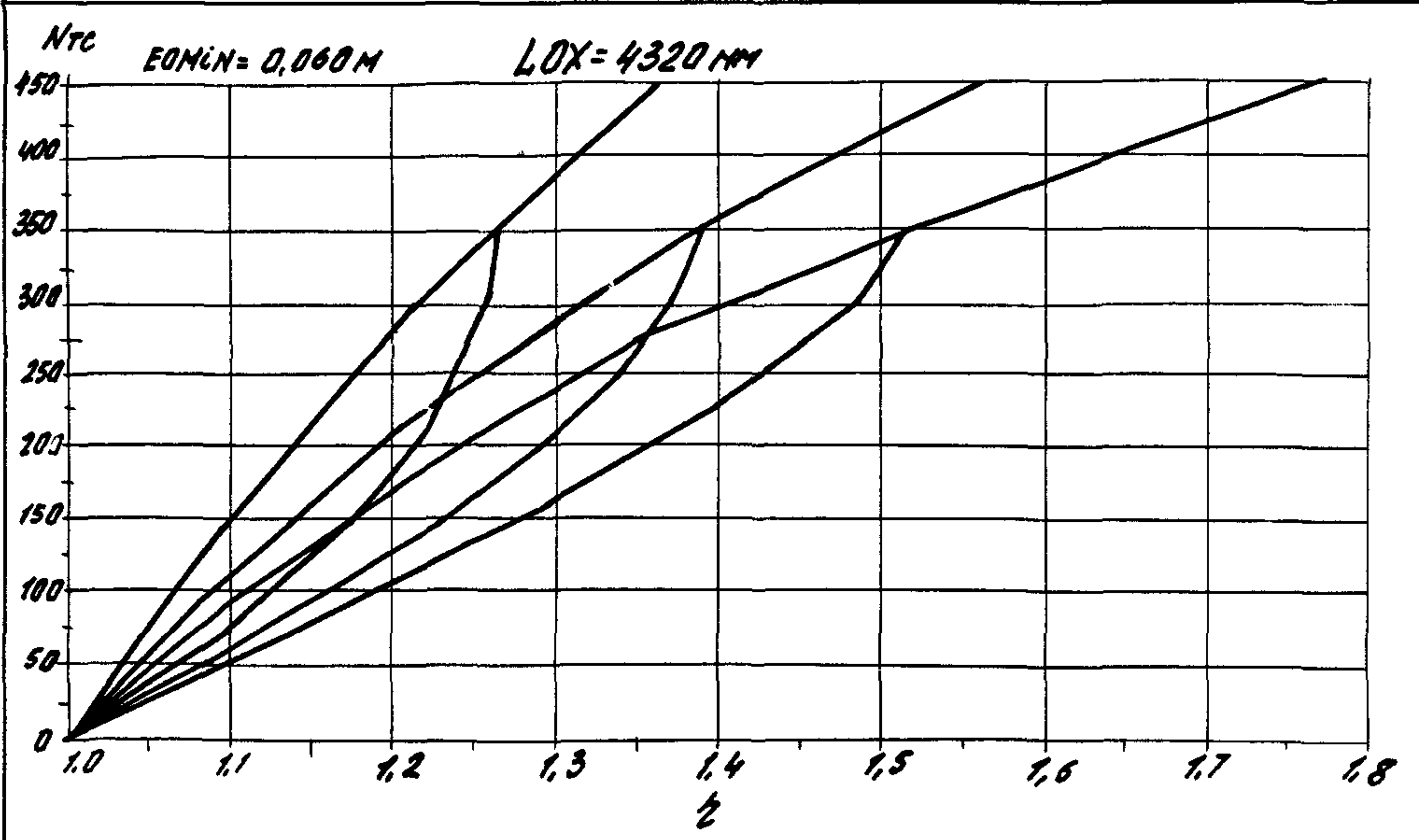

УНБ АИРОБА Д. 7-муҳо у ОАТТ ВАРМ. УНБ. АР

1.020.1-4 0-9 002 139

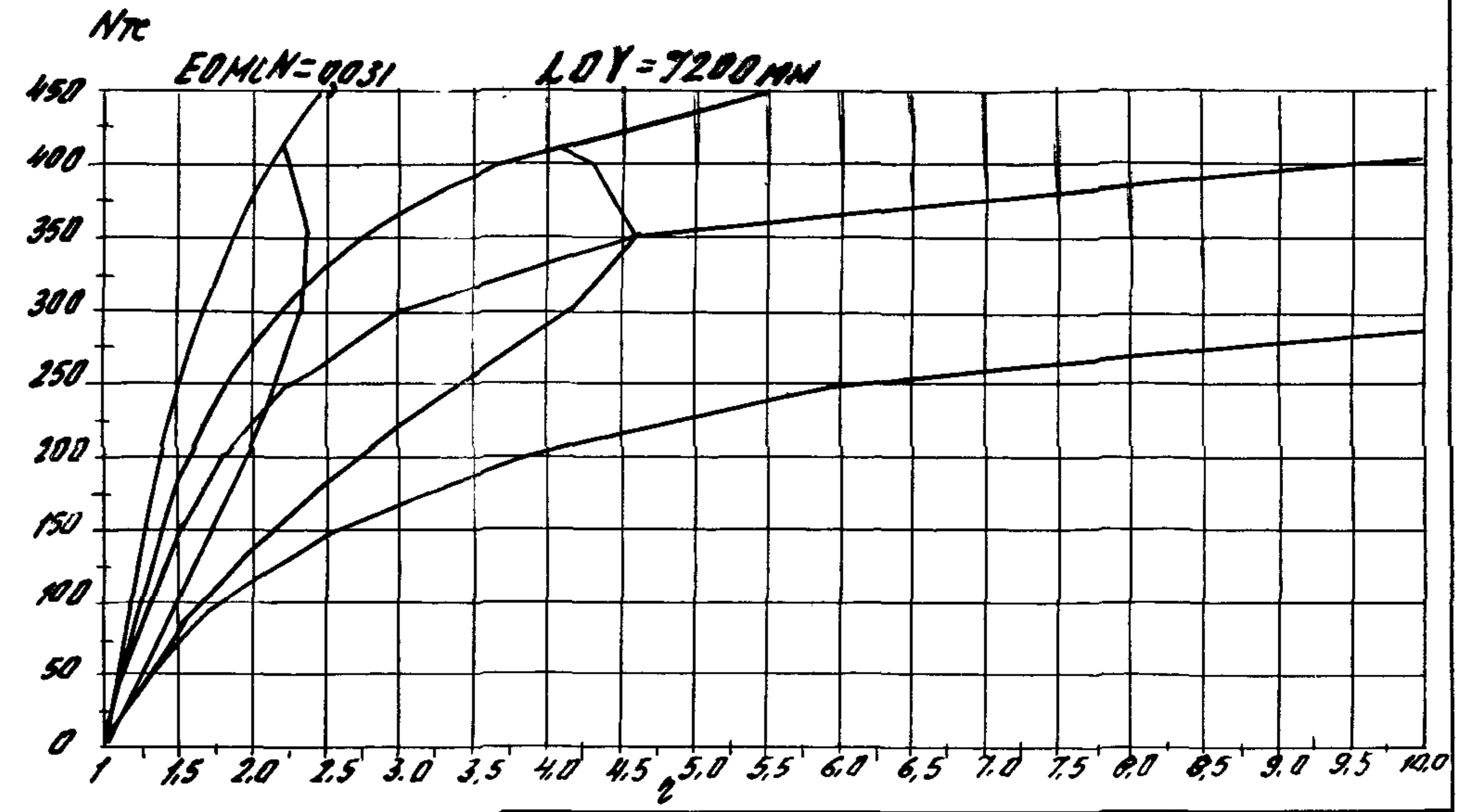
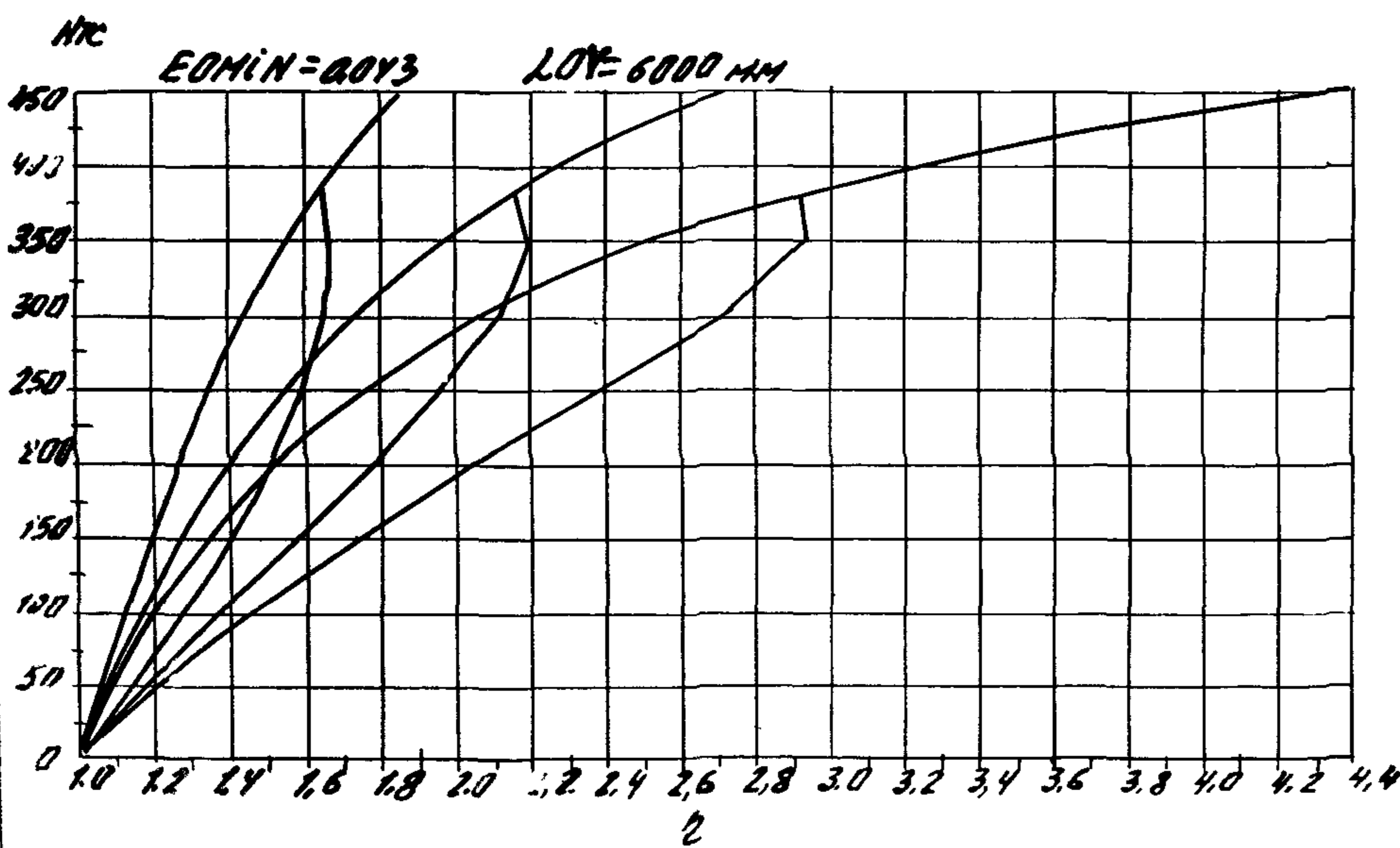
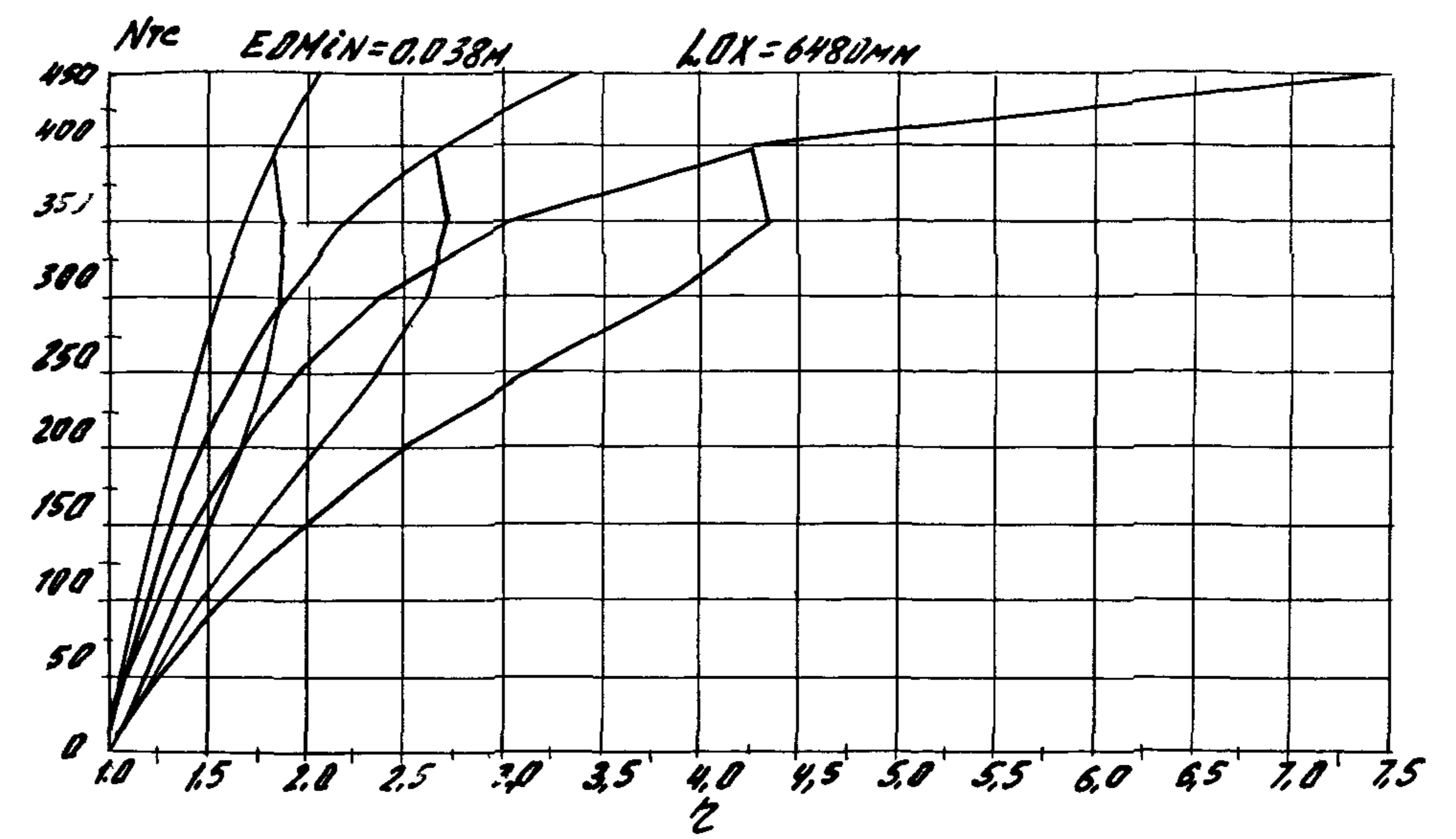
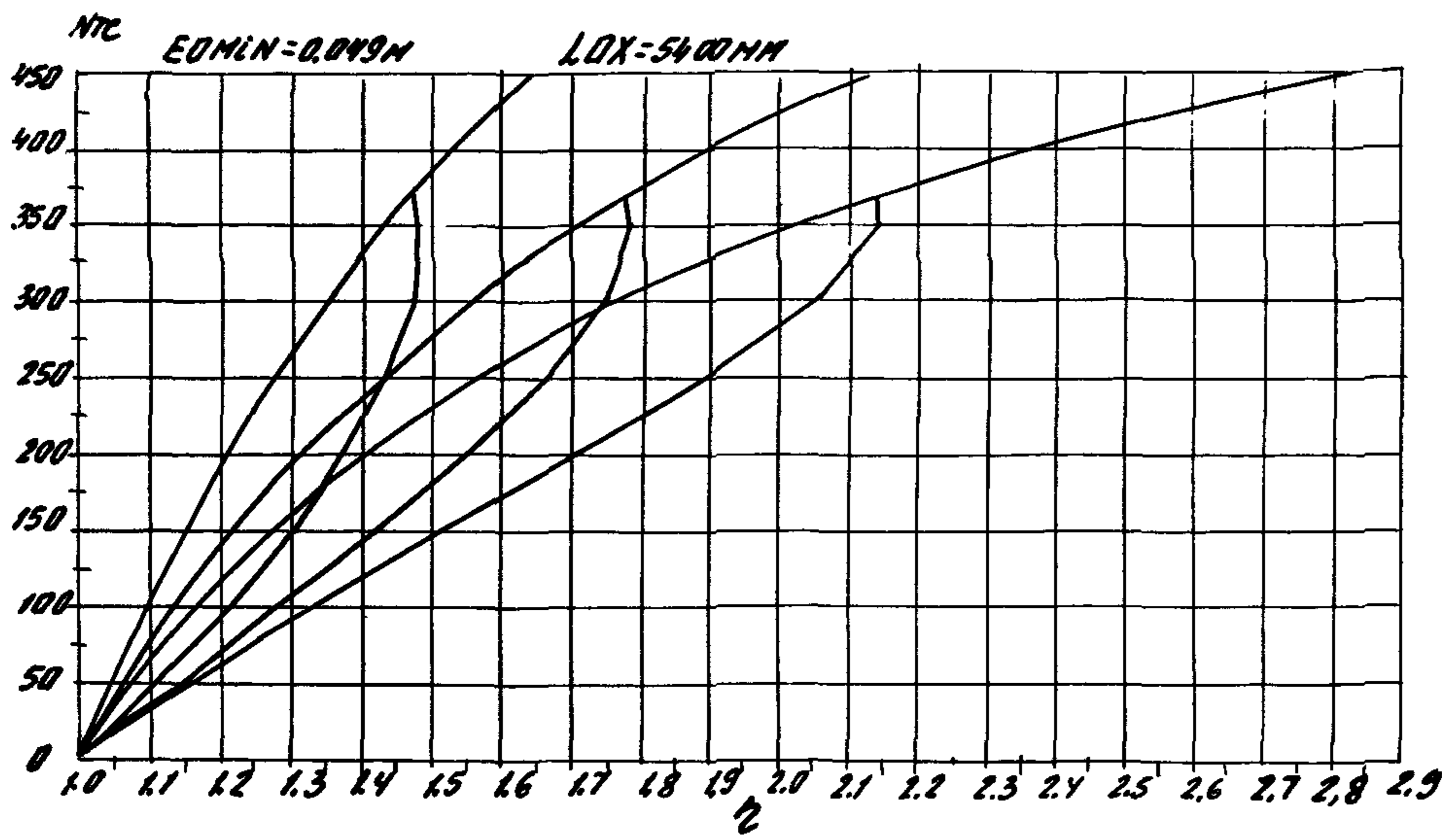

410.03 подл. Подписано и датум 1939г. Уво. № 2

1.020.1-4 0-9 002 ДУЕТ
140

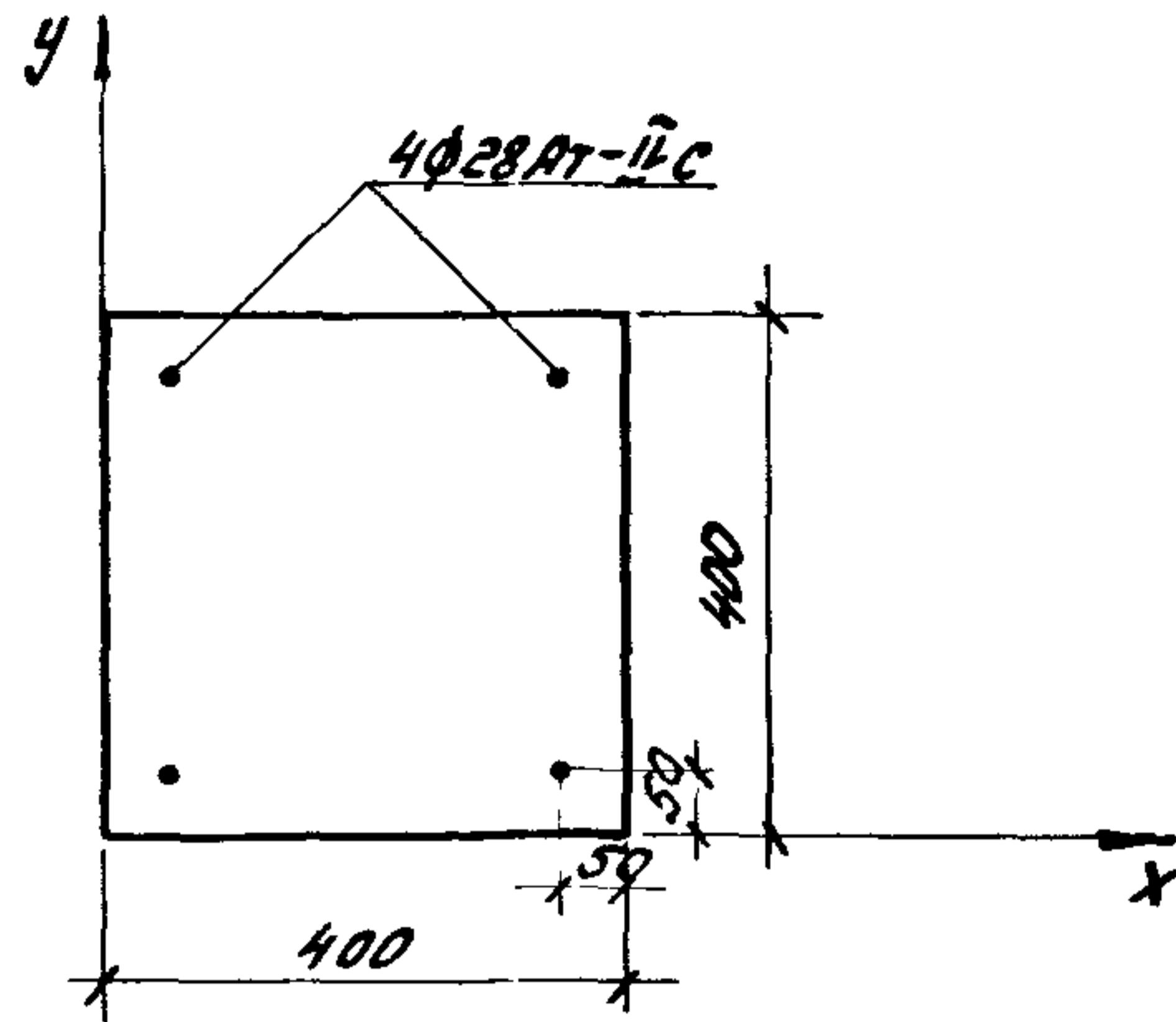
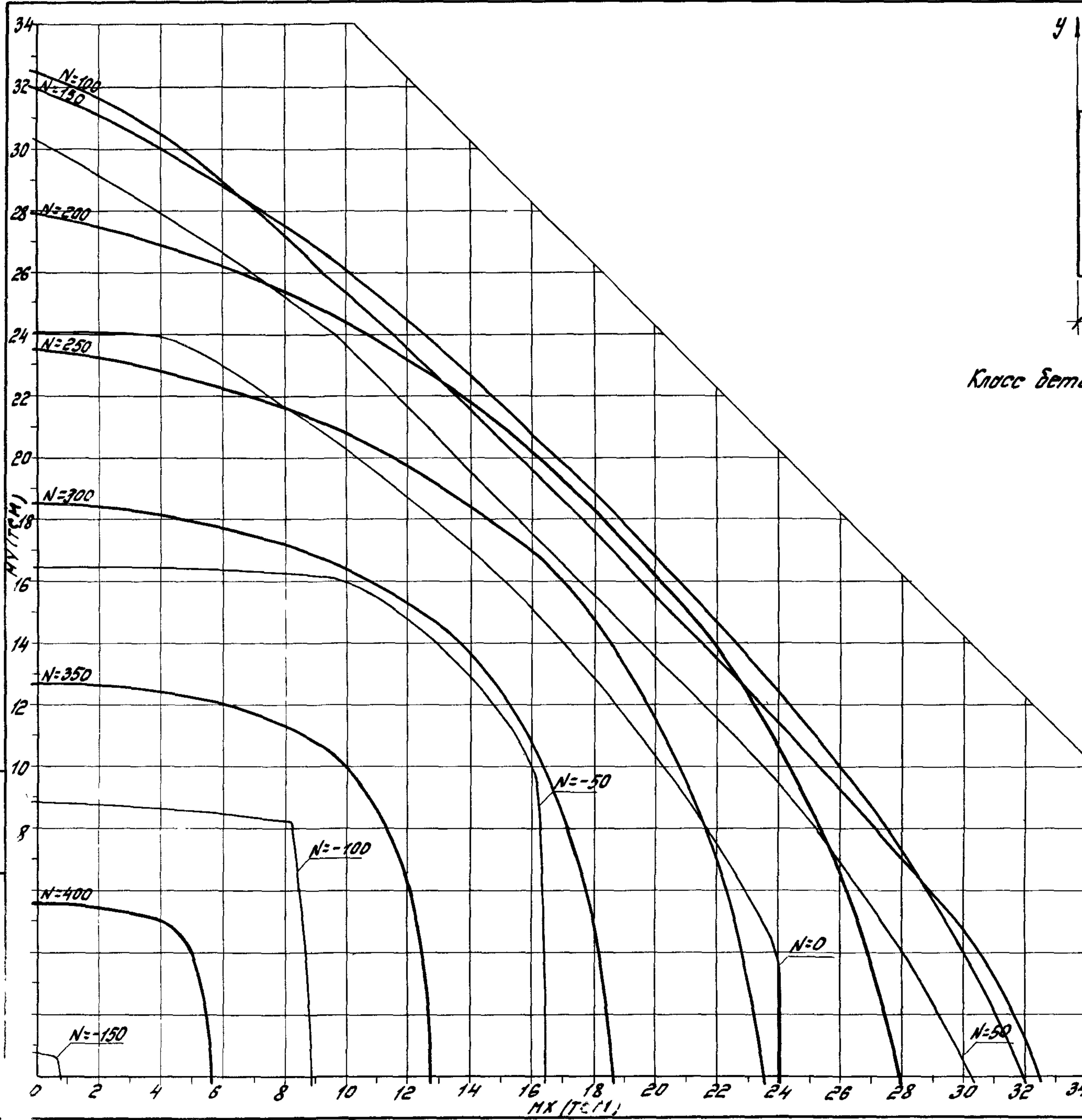

Класс бетона В40.0 ($R_b = 19.8 \text{ МПа}$ при учёте $\gamma_{b2} = 0.90$)
 Сталь Ат-ІІС
 Код сечения - 1135

1.020. 1-4 0-3 002 14

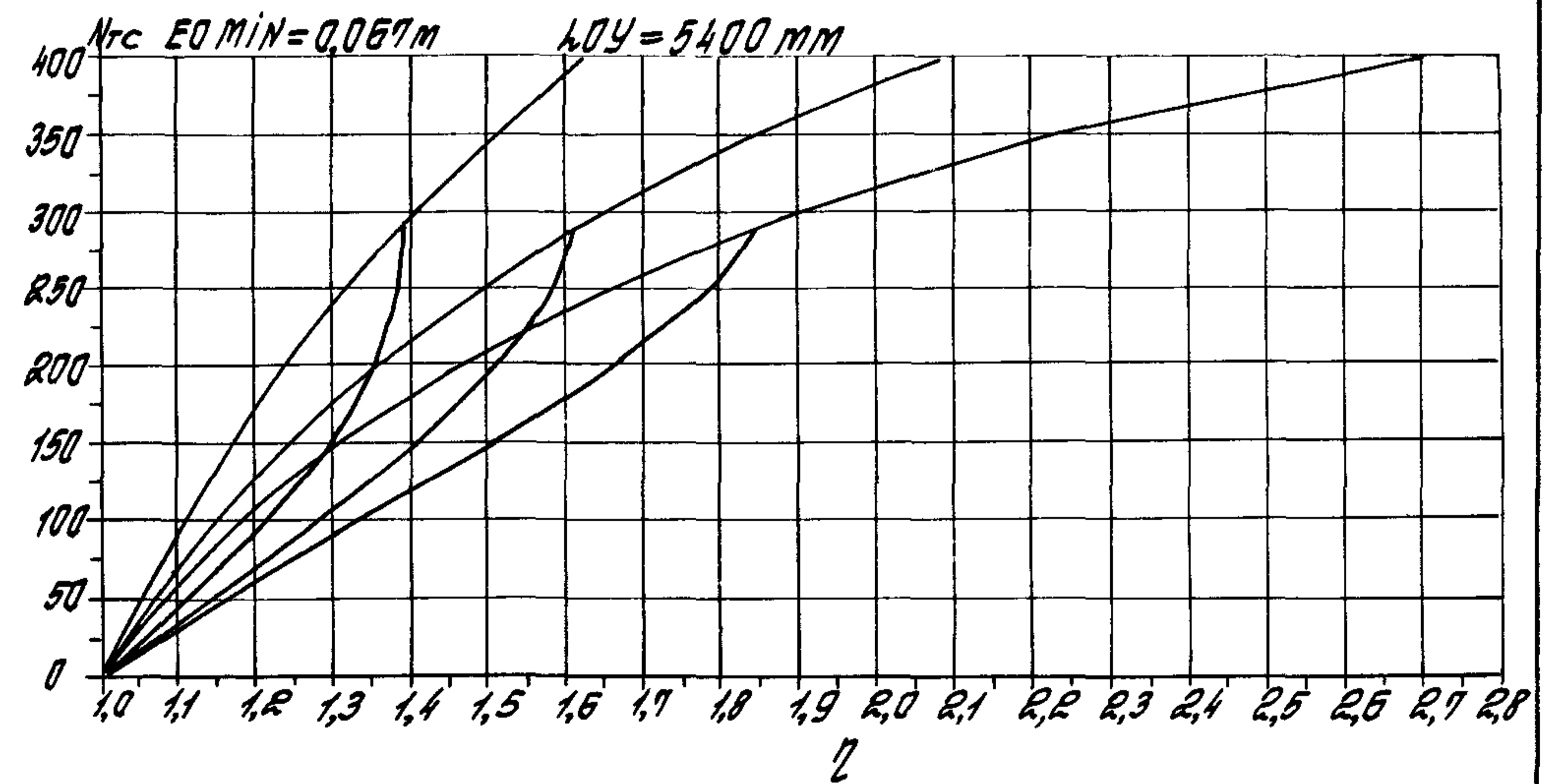
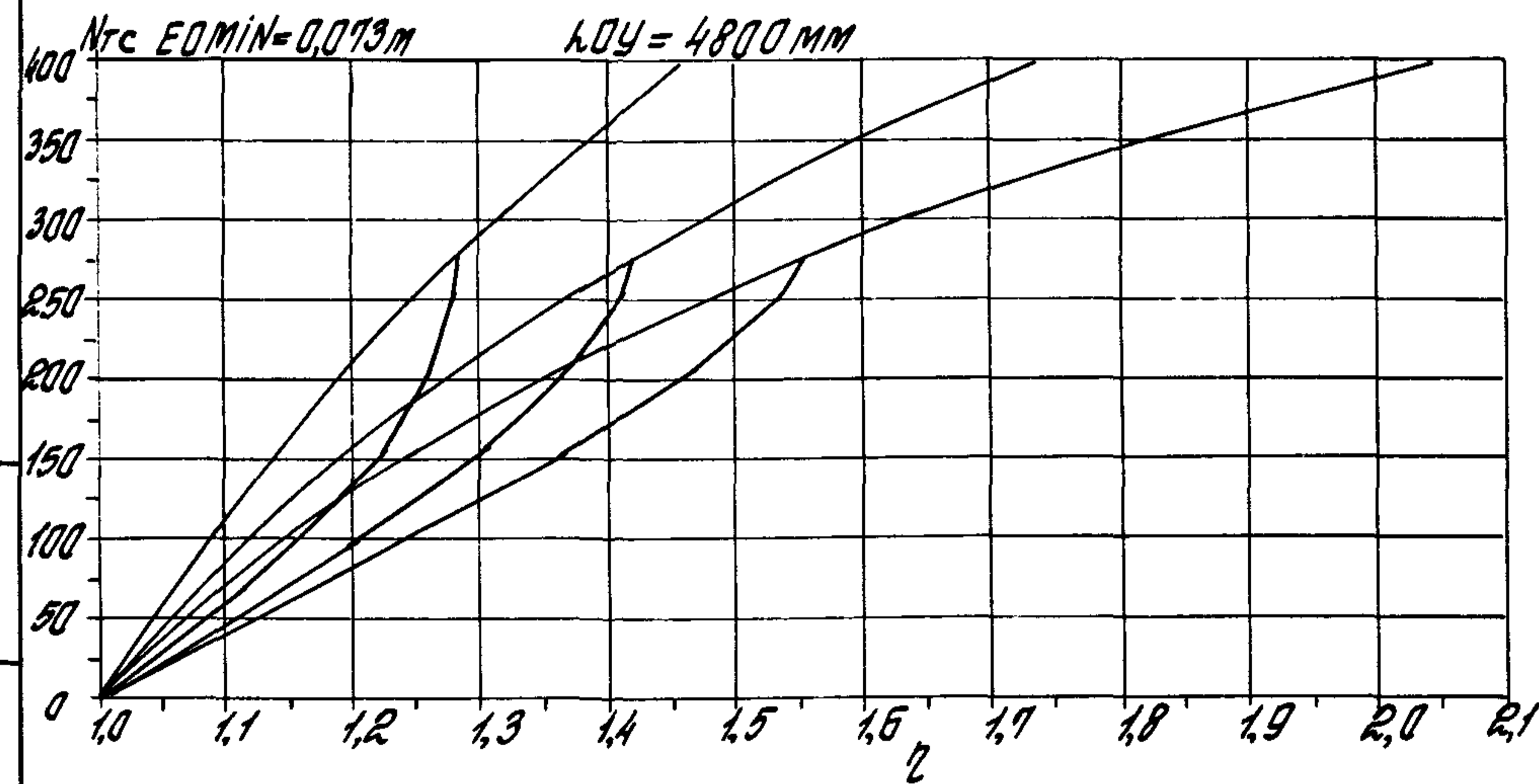
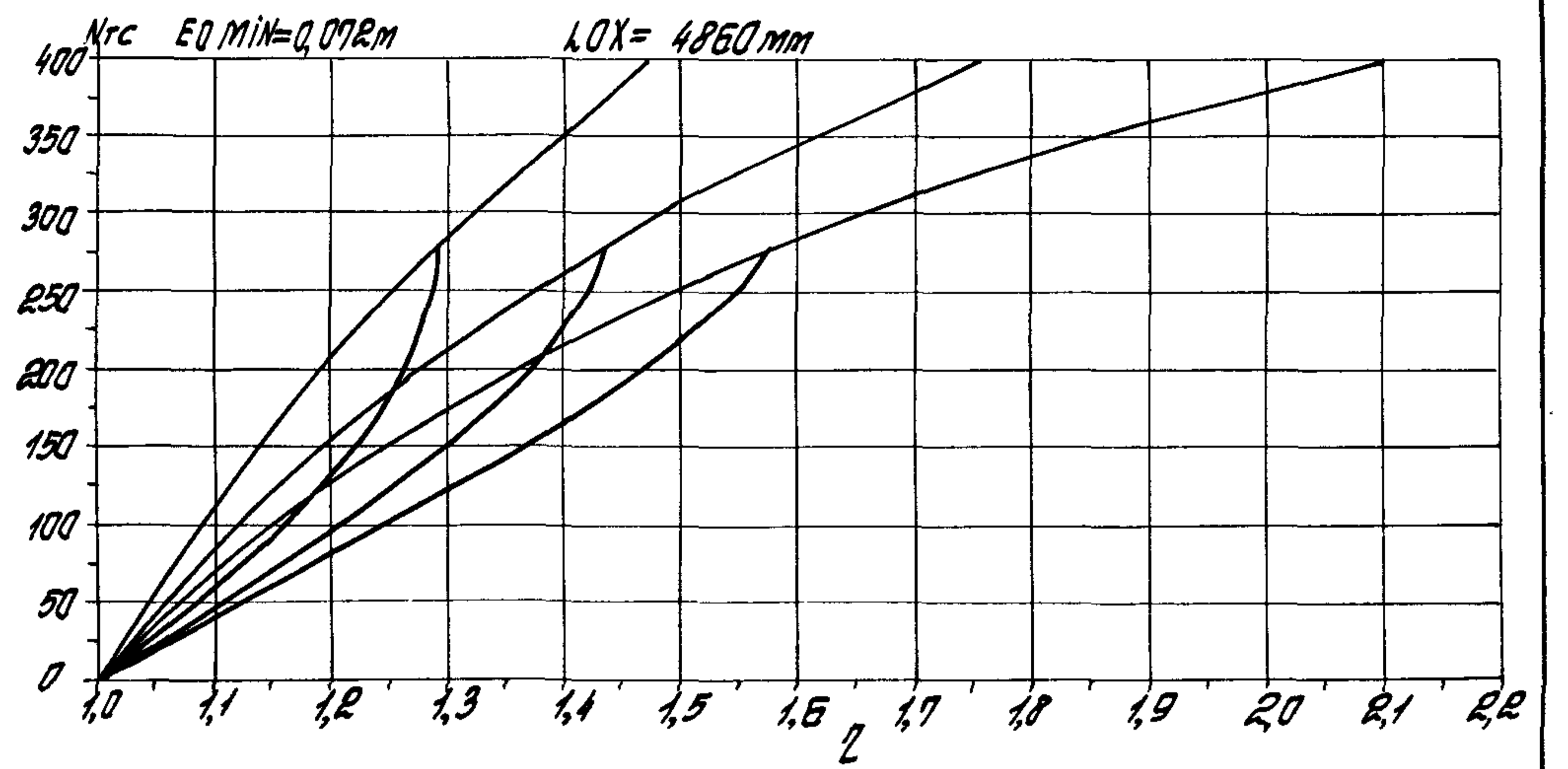
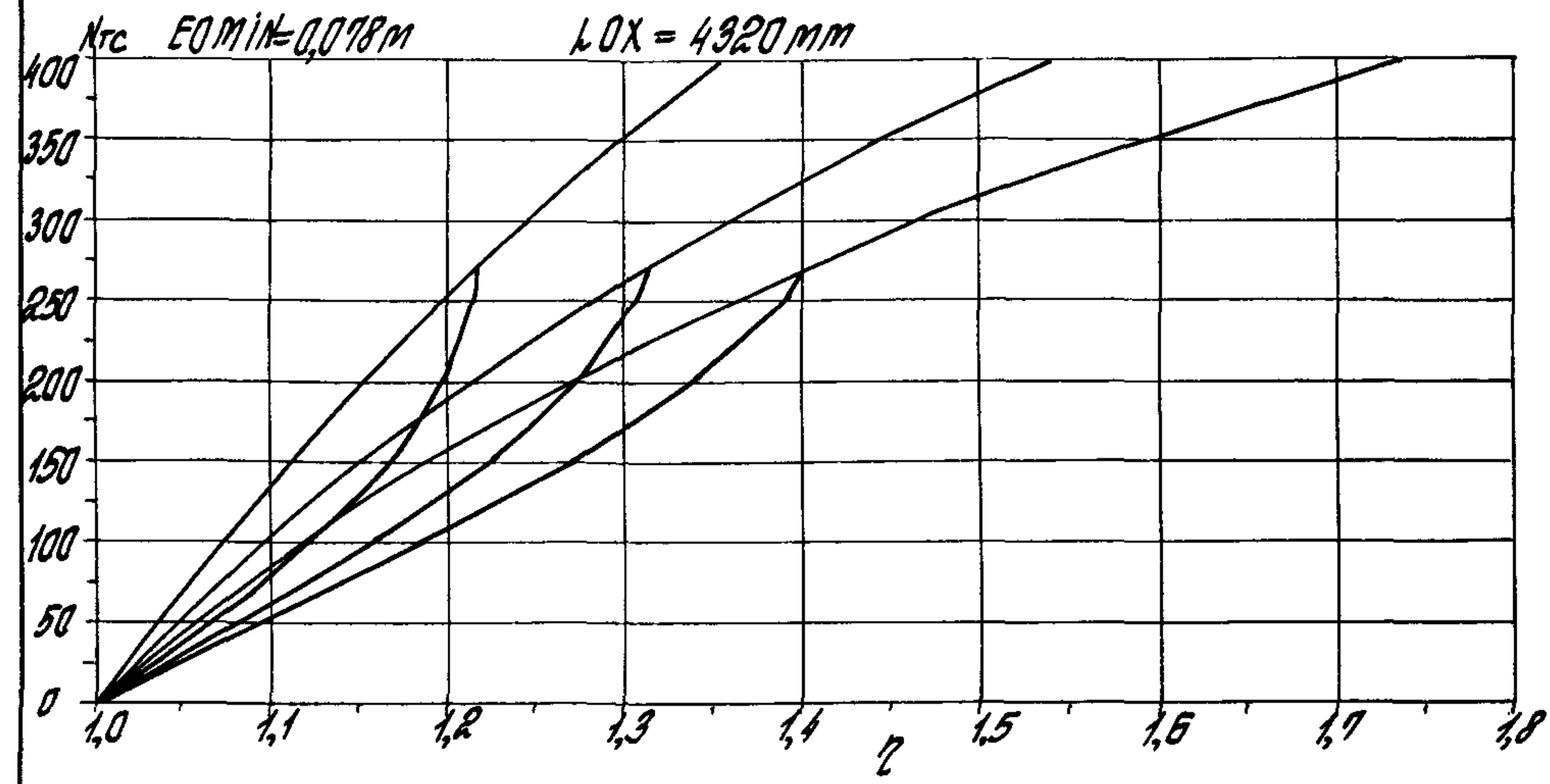

1.020.1-4 0-9 002 Lucm
143

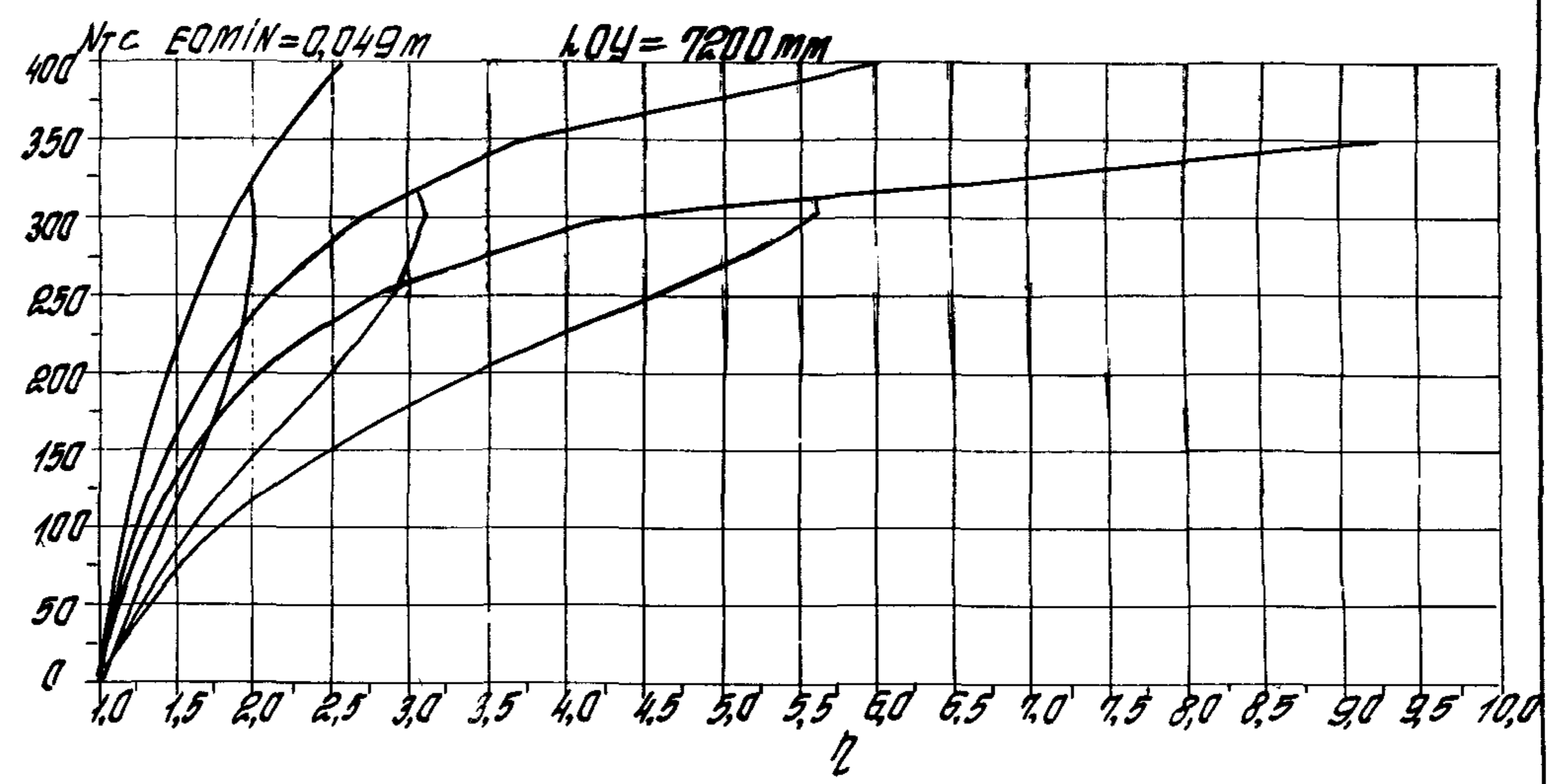
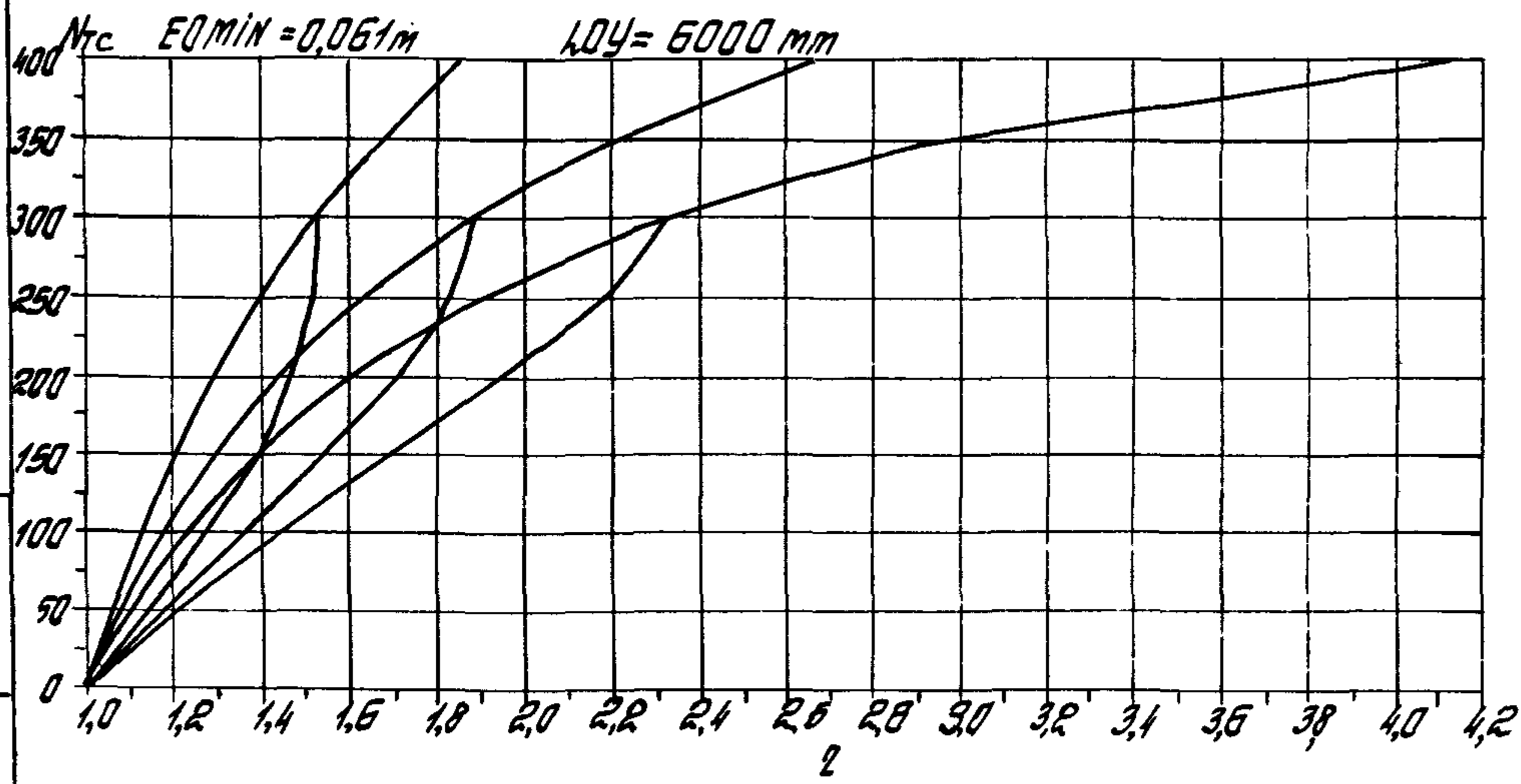
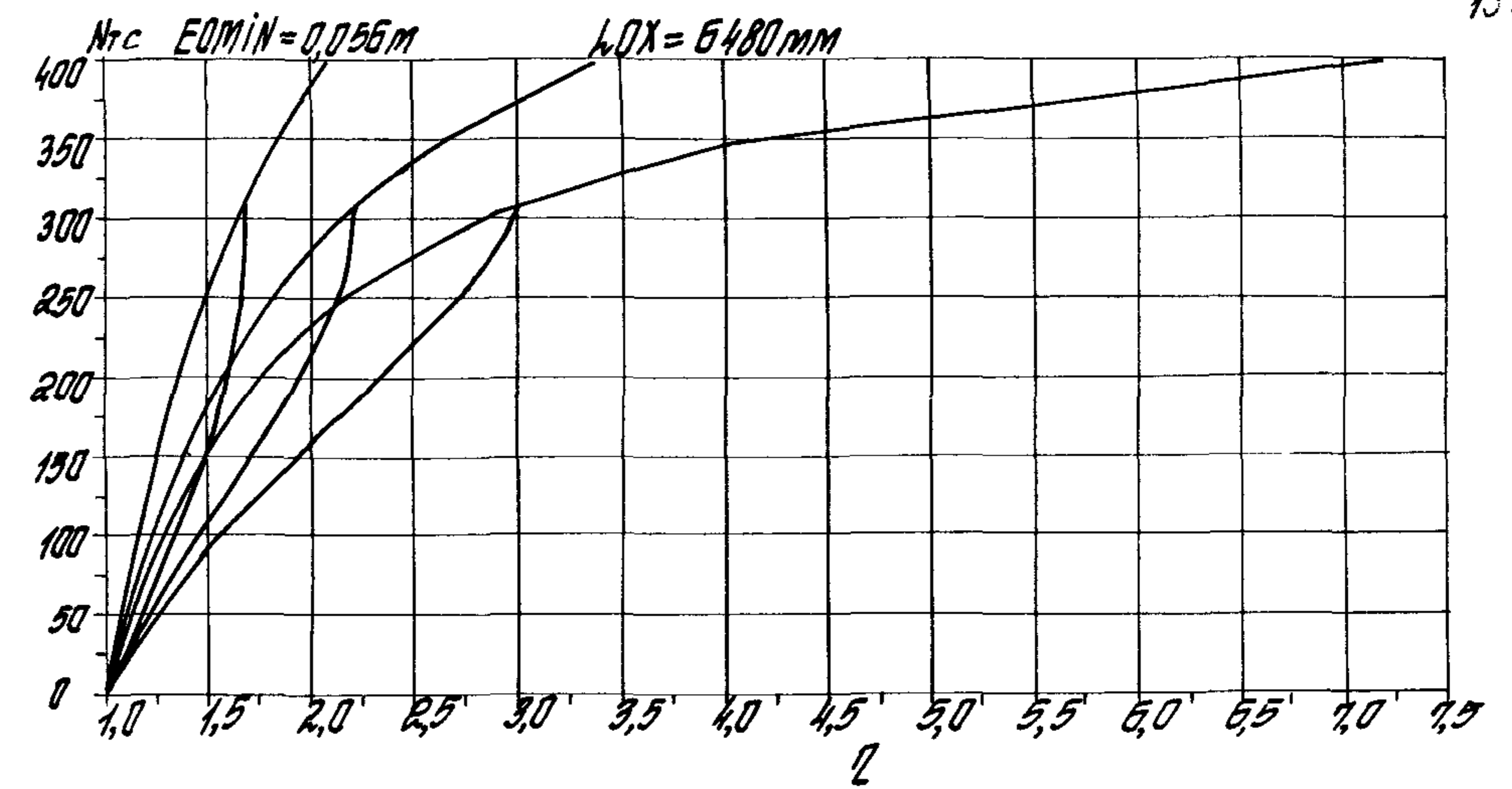
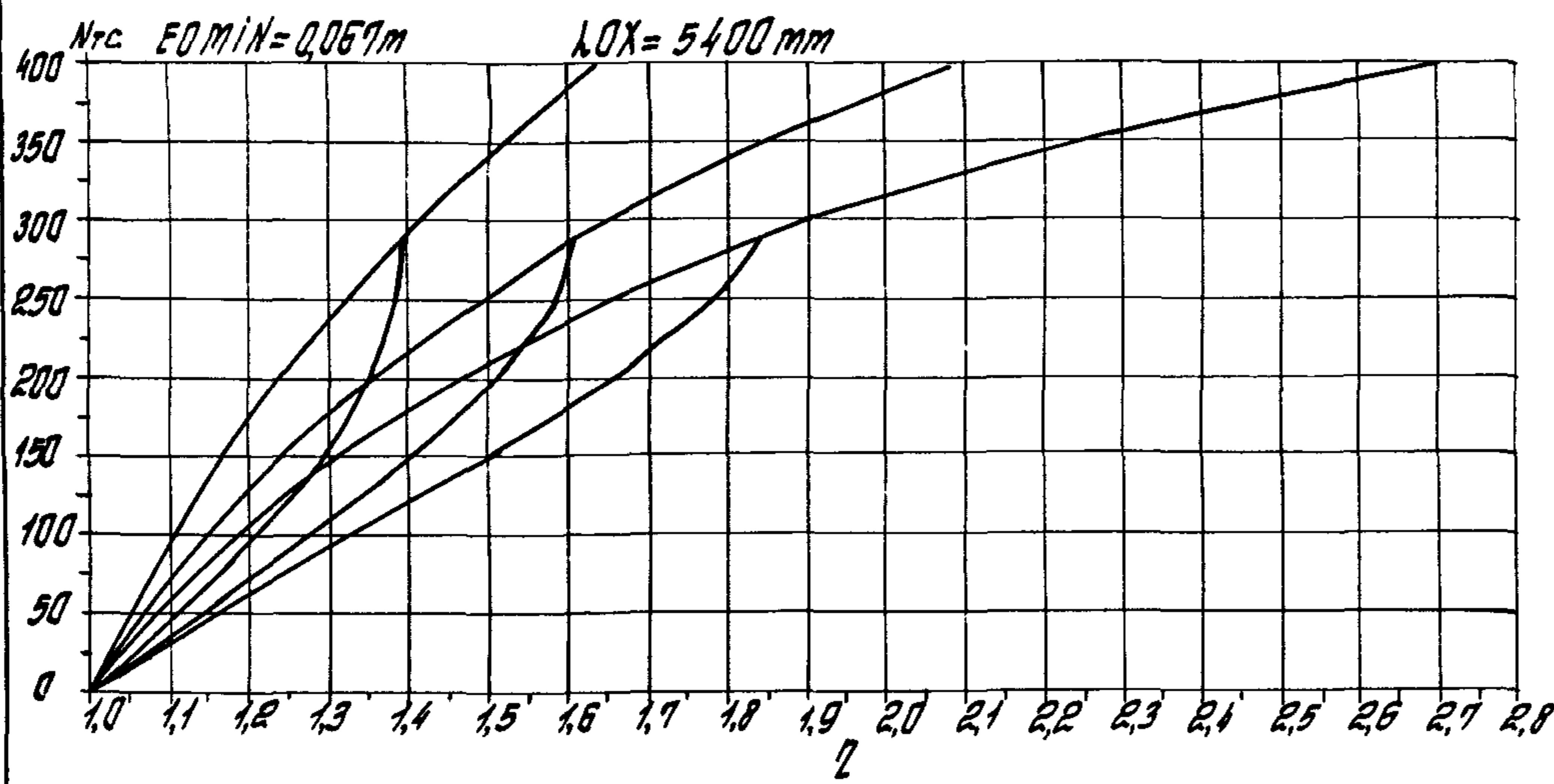

УДБ № 100А. Модуль и форма. 8300. 1000. 1000.

1.020.1-4 0-9 002

Лист	144
------	-----

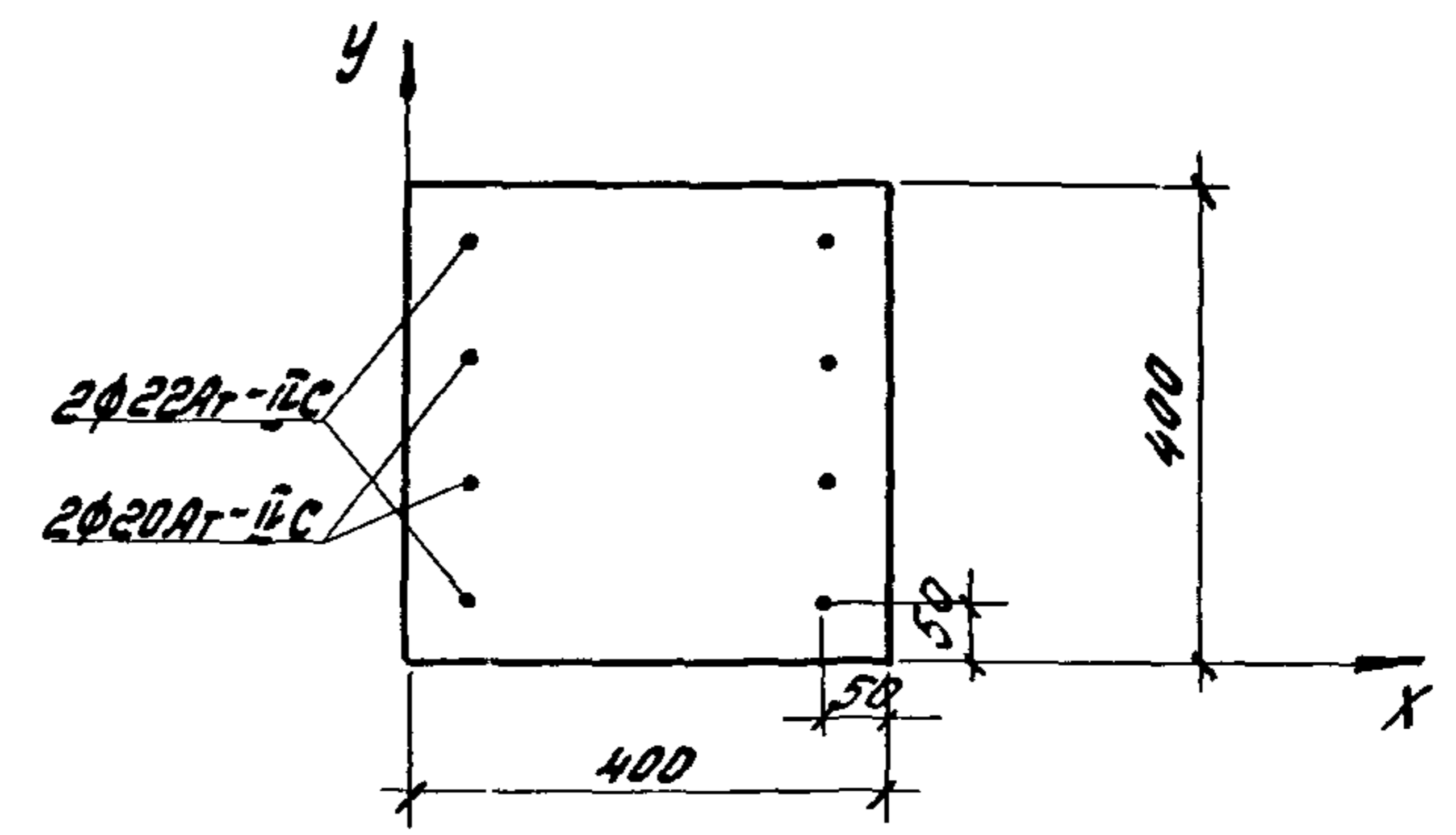
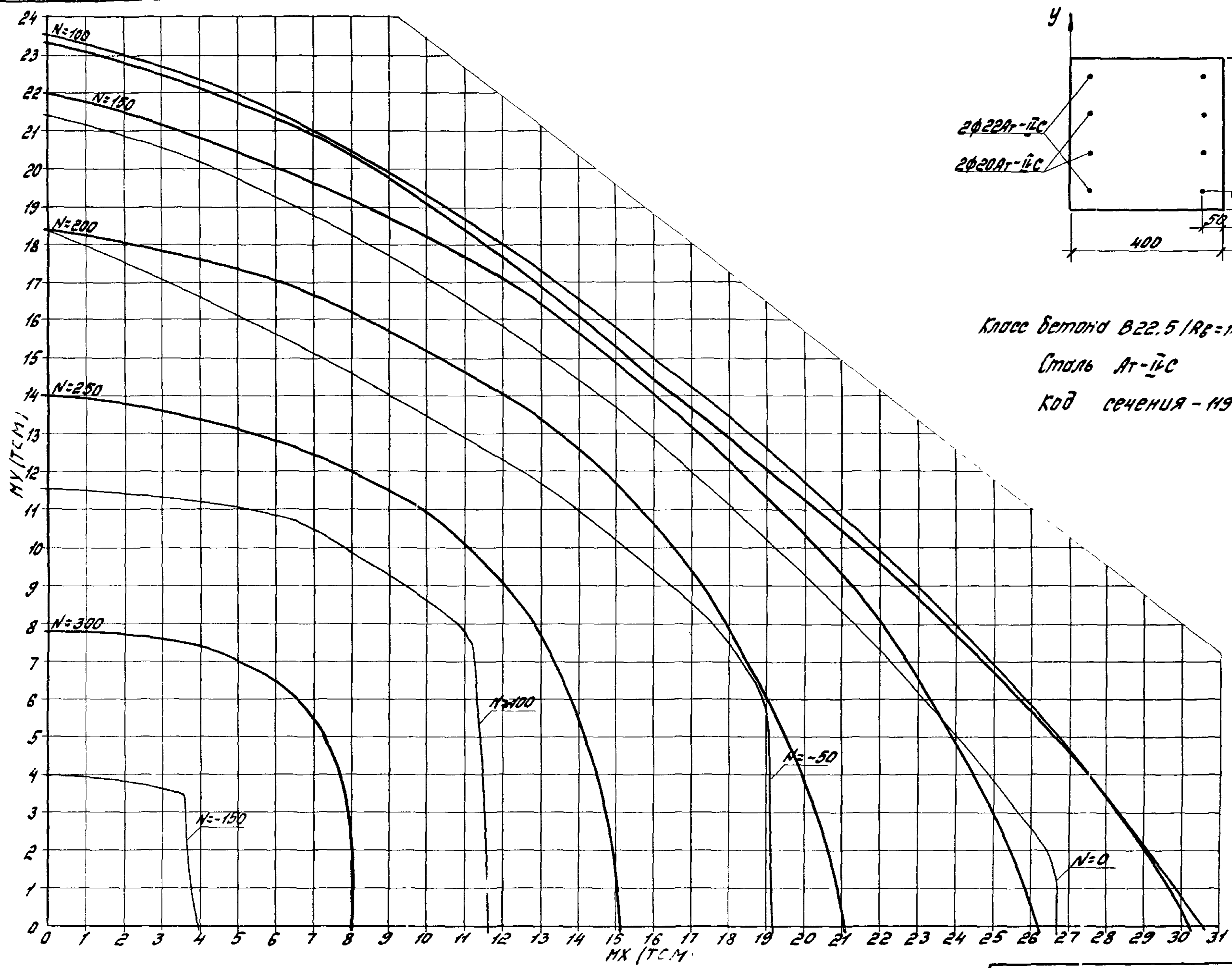

Класс бетона В22.5 ($R_b = 14.3 \text{ МПа}$ при учете $\gamma_{R2} = 1.10$)
 Сталь Ar-IIIc
 Код сечения - Н9ц

СДП. М. 1-111111

1.025. 1-4	0-У	002	Лист 145
------------	-----	-----	-------------

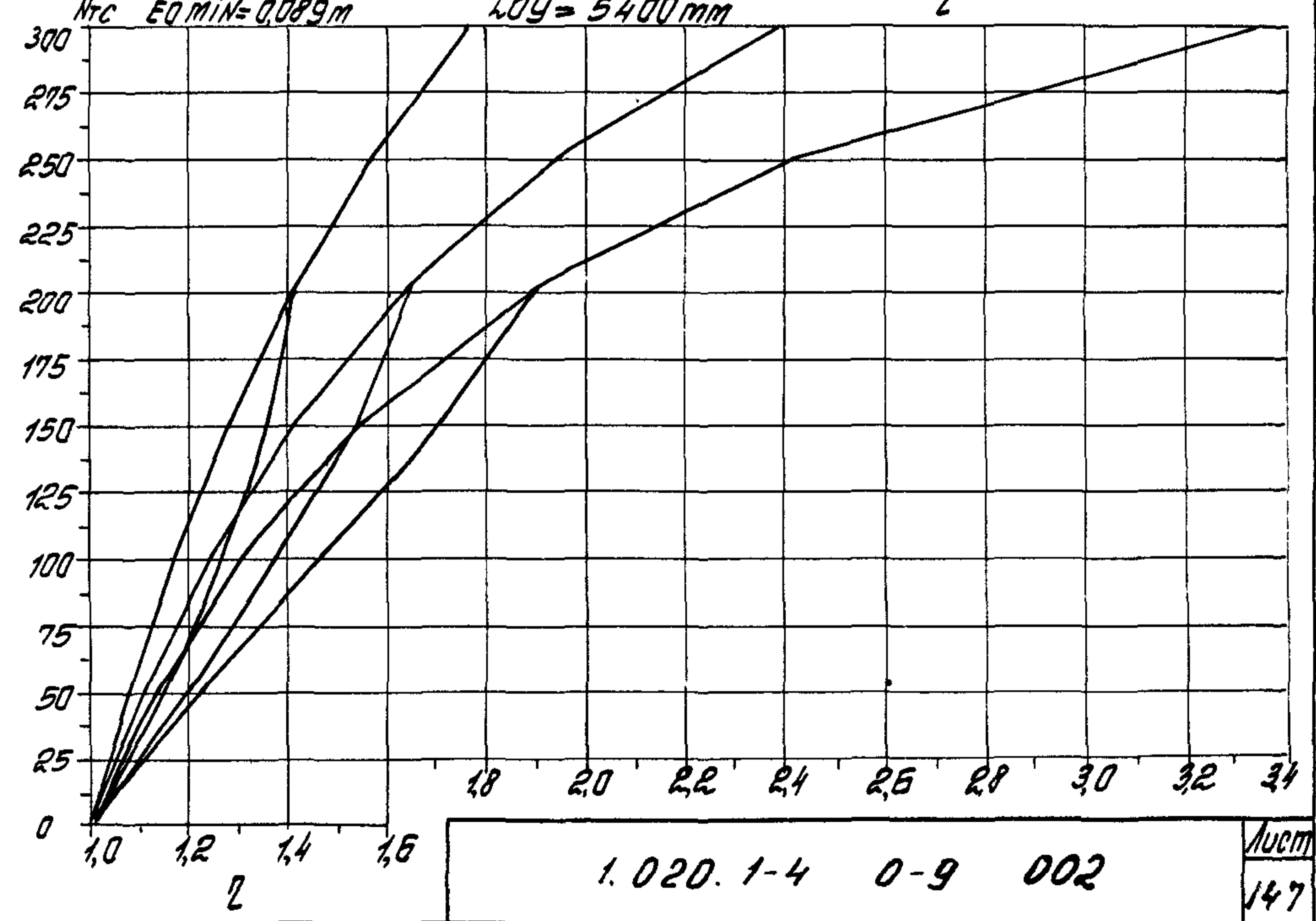
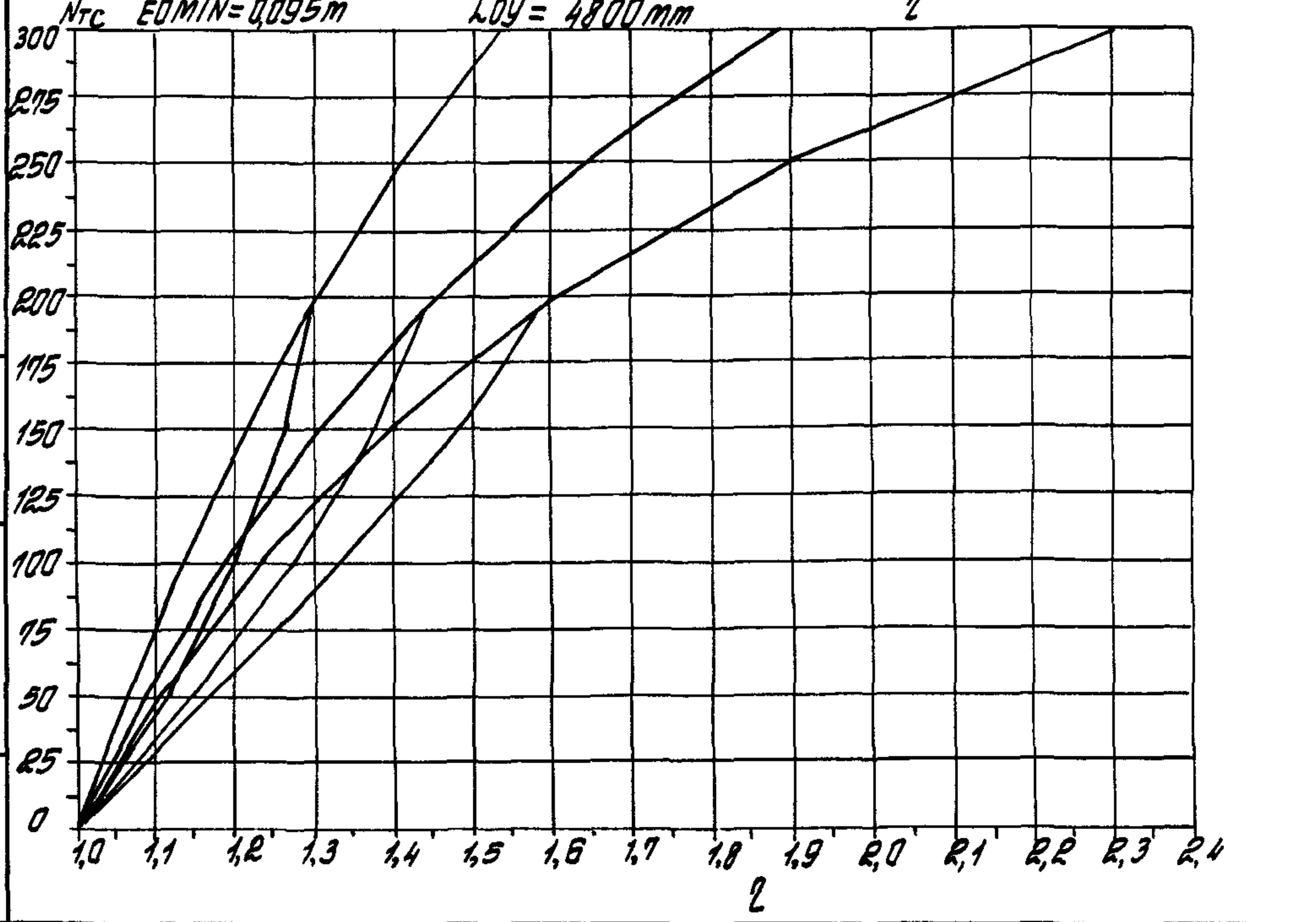
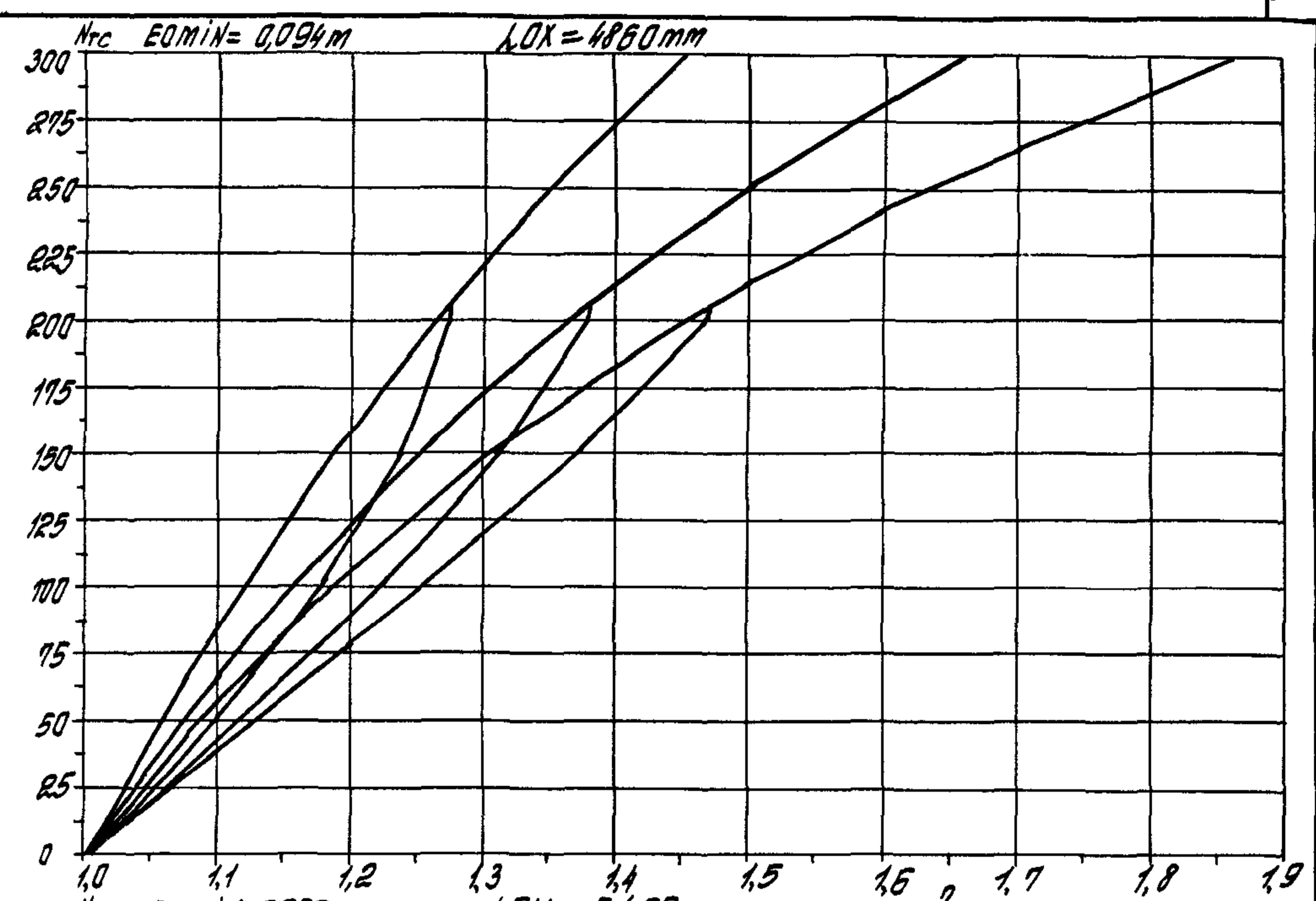
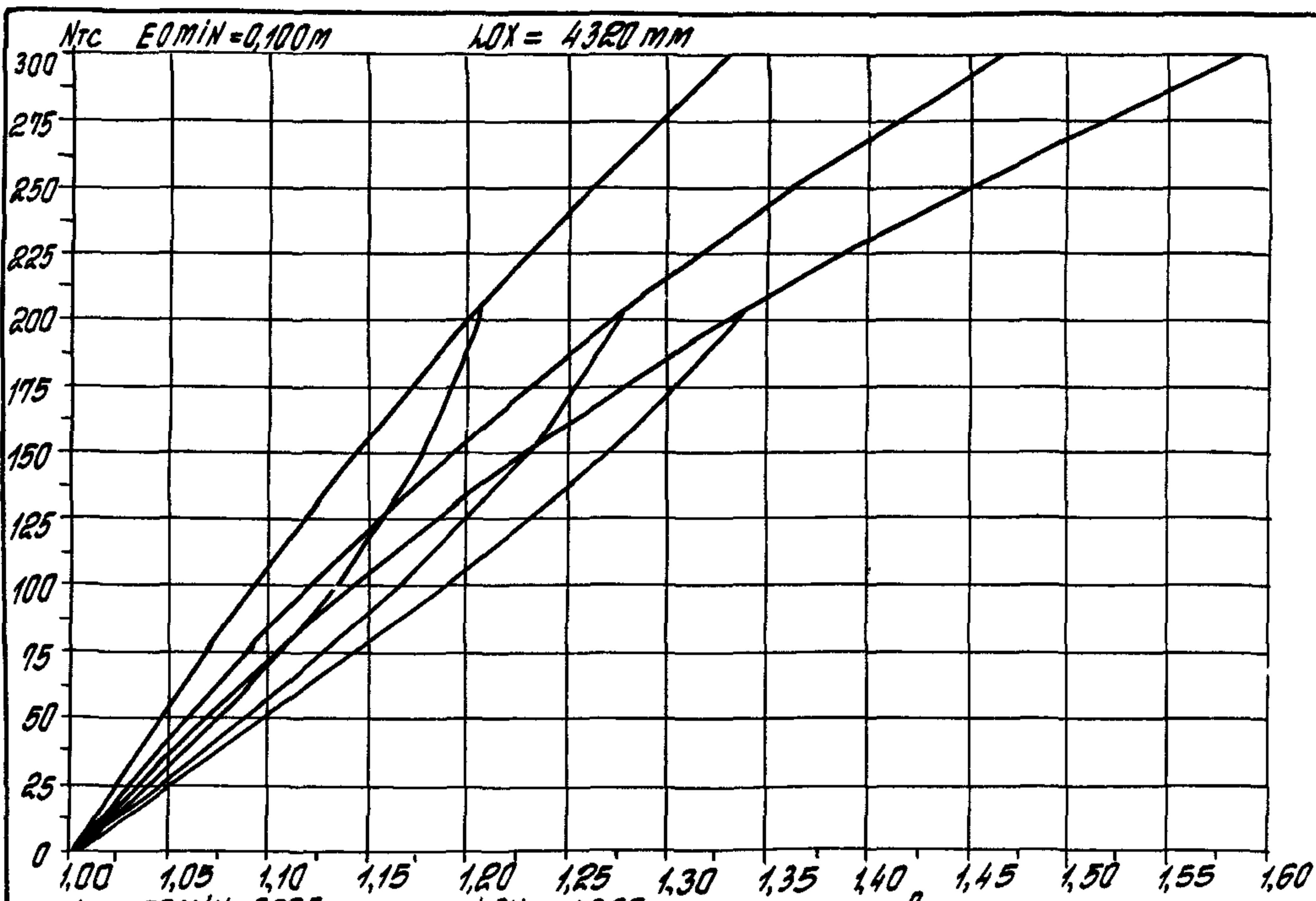

УИЧ. № подл. Подпись и дата. Взам. инв. №

1.020.1-4 0-9 002
Лист 147

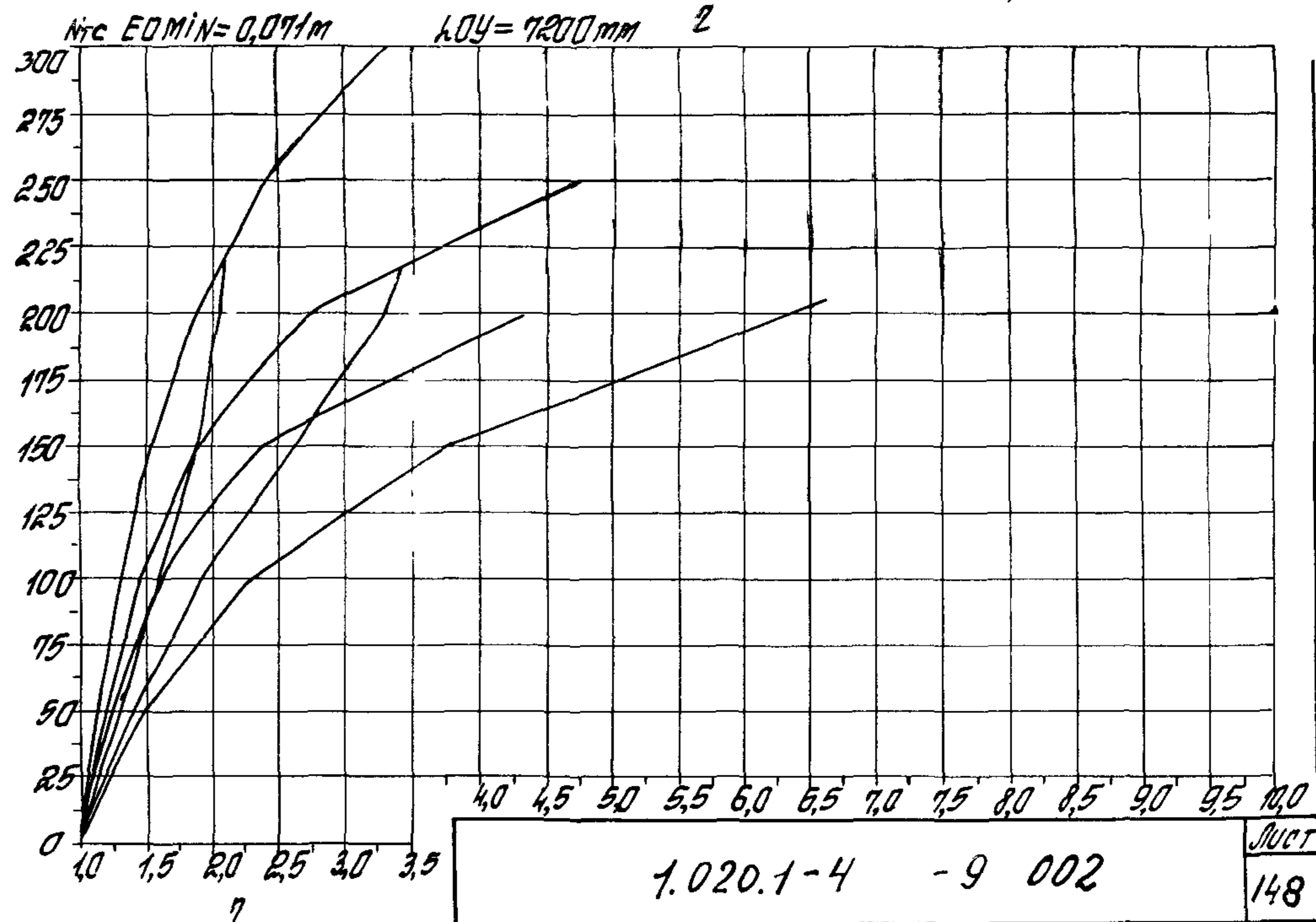
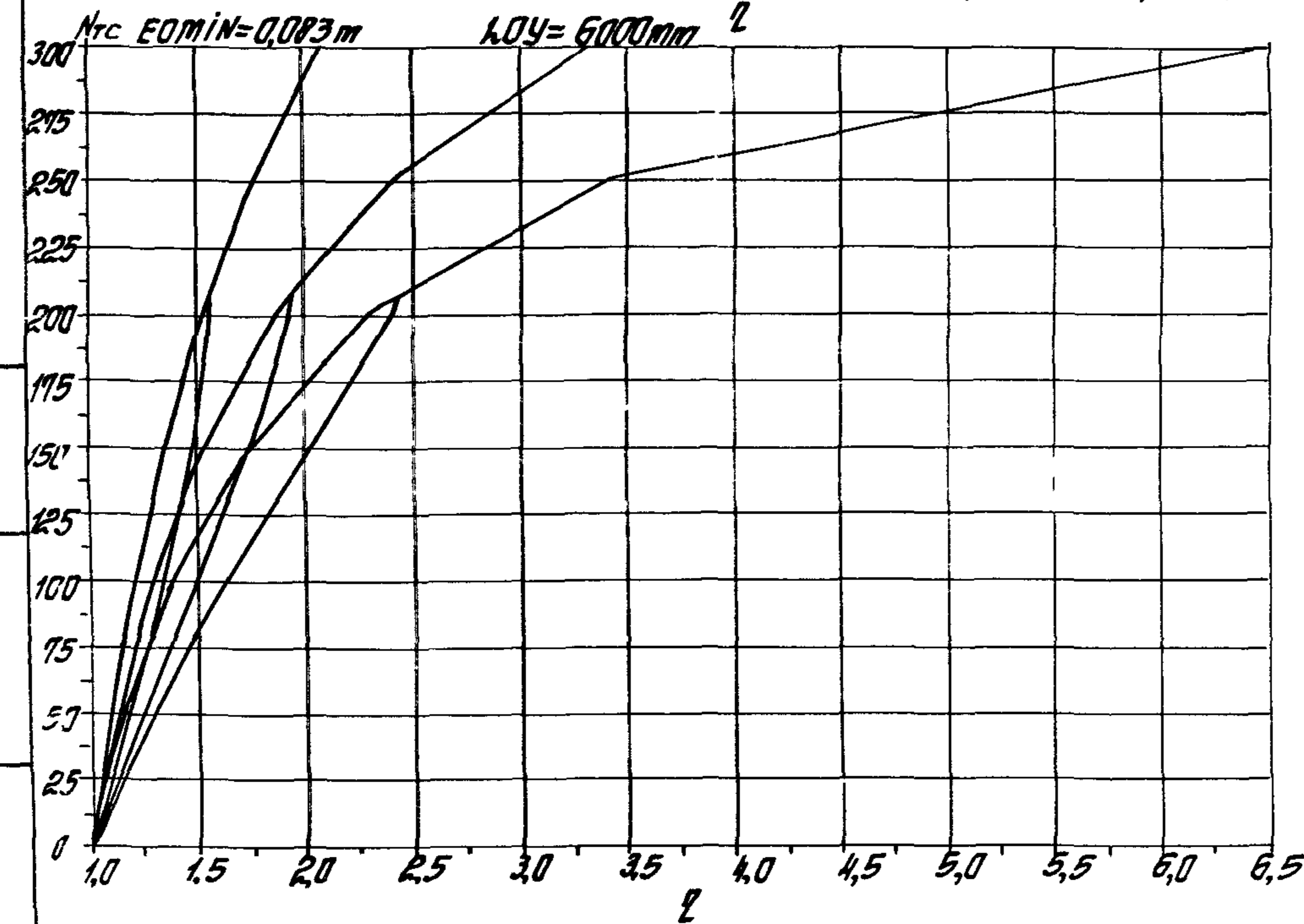
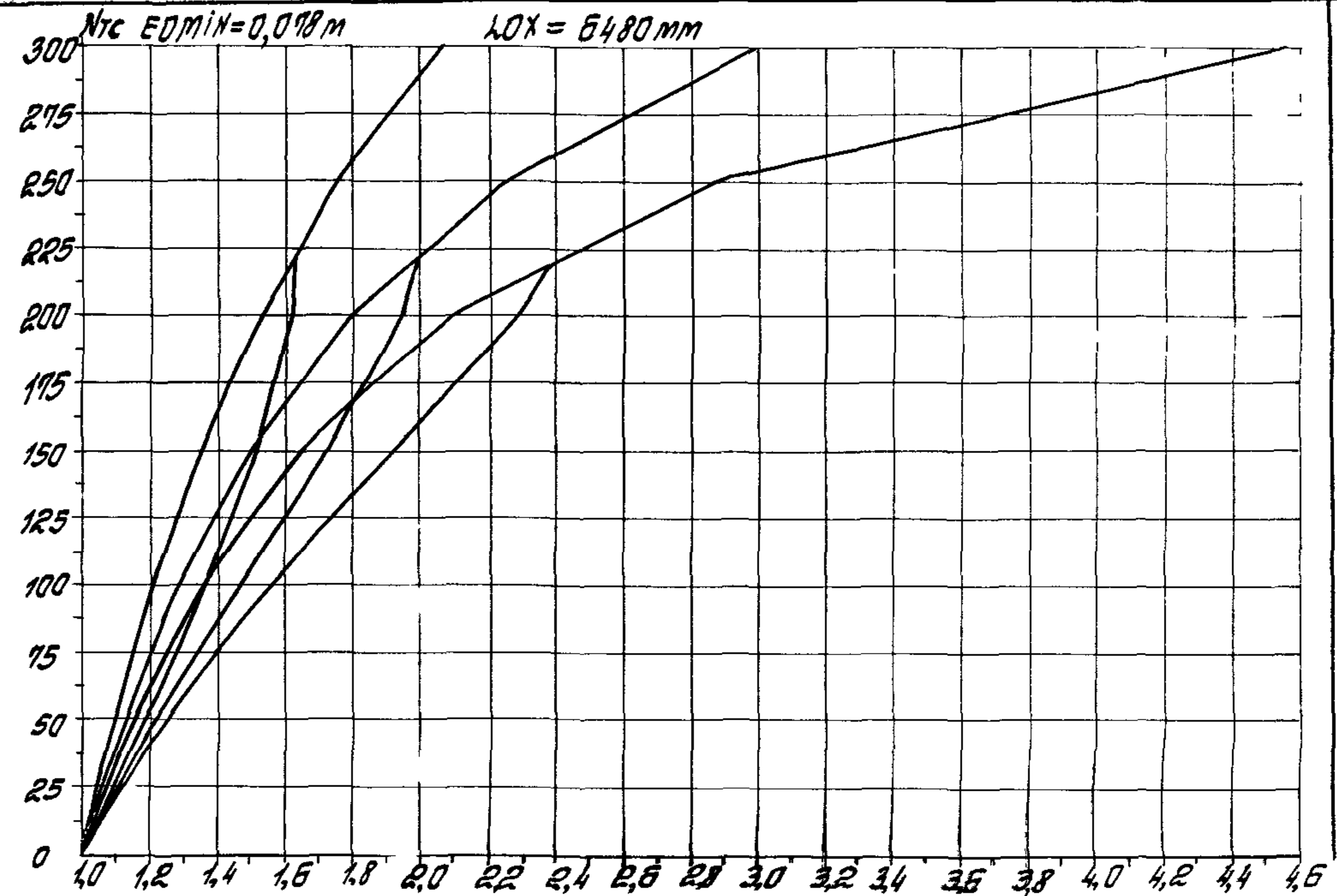
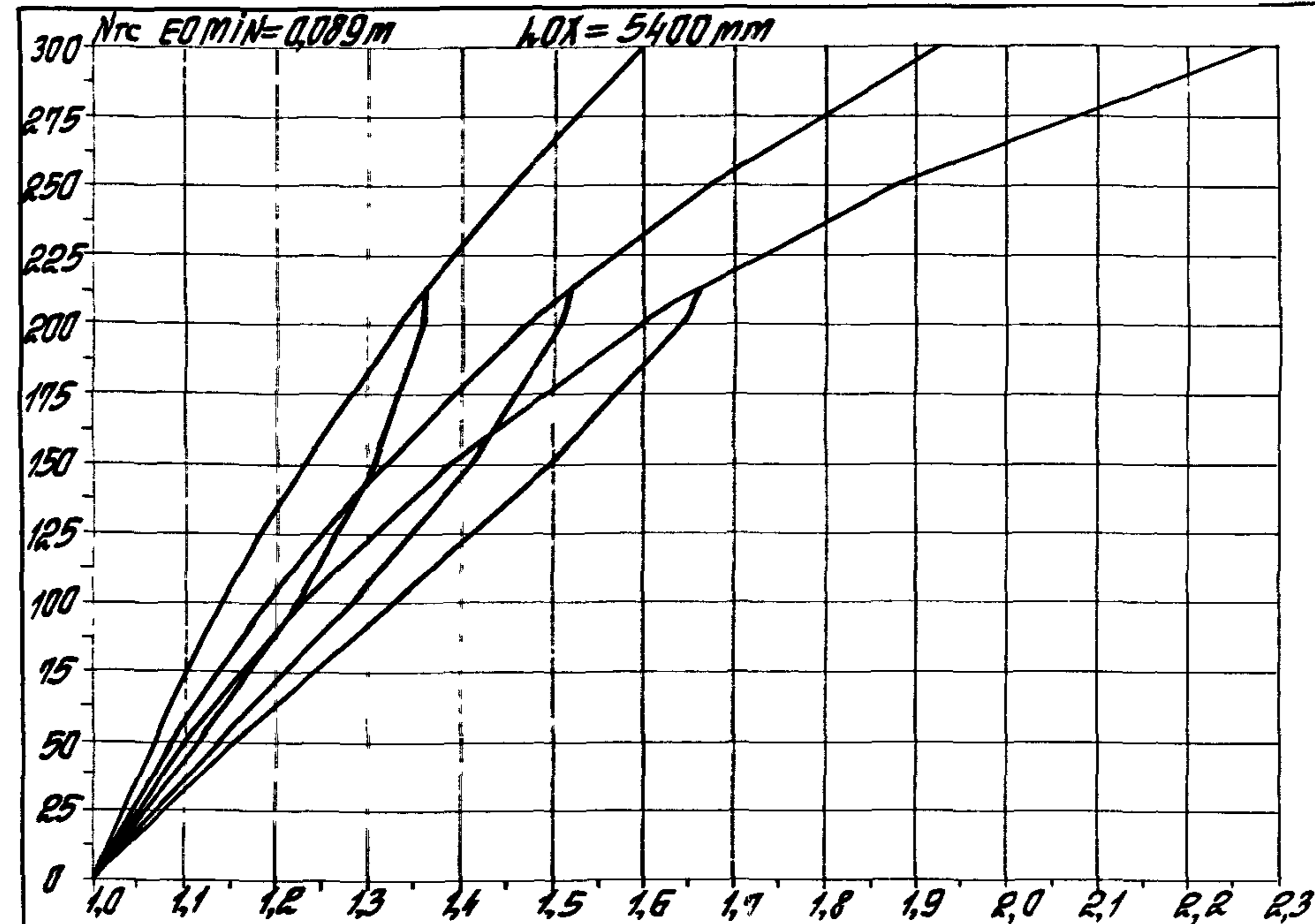

Упр. № 1000. Подпись и дата. 11.11.89

4,0 4,5 5,0 5,5 6,0 6,5 7,0 7,5 8,0 8,5 9,0 9,5 10,0

1.020.1-4 - 9 002

148

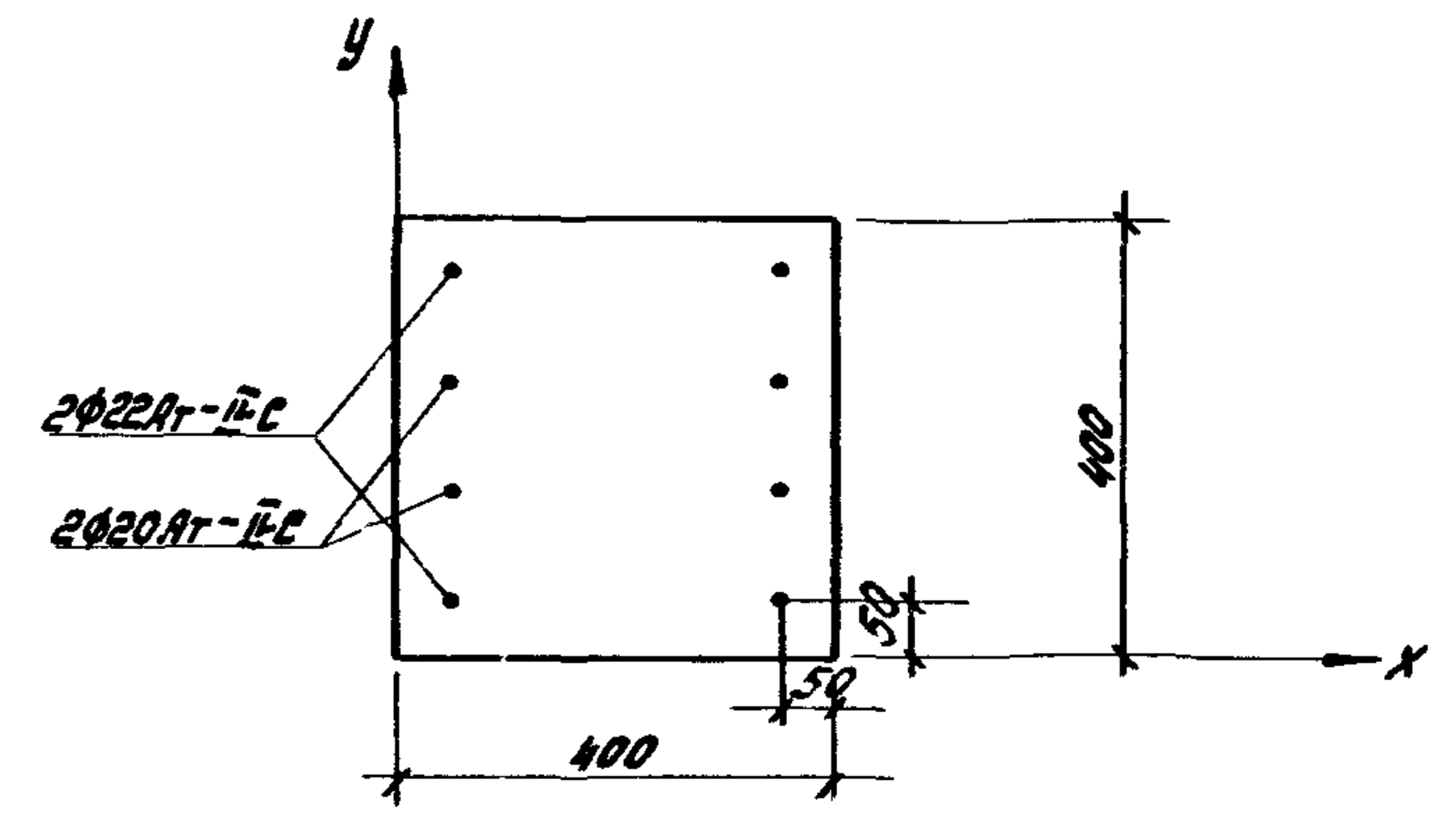
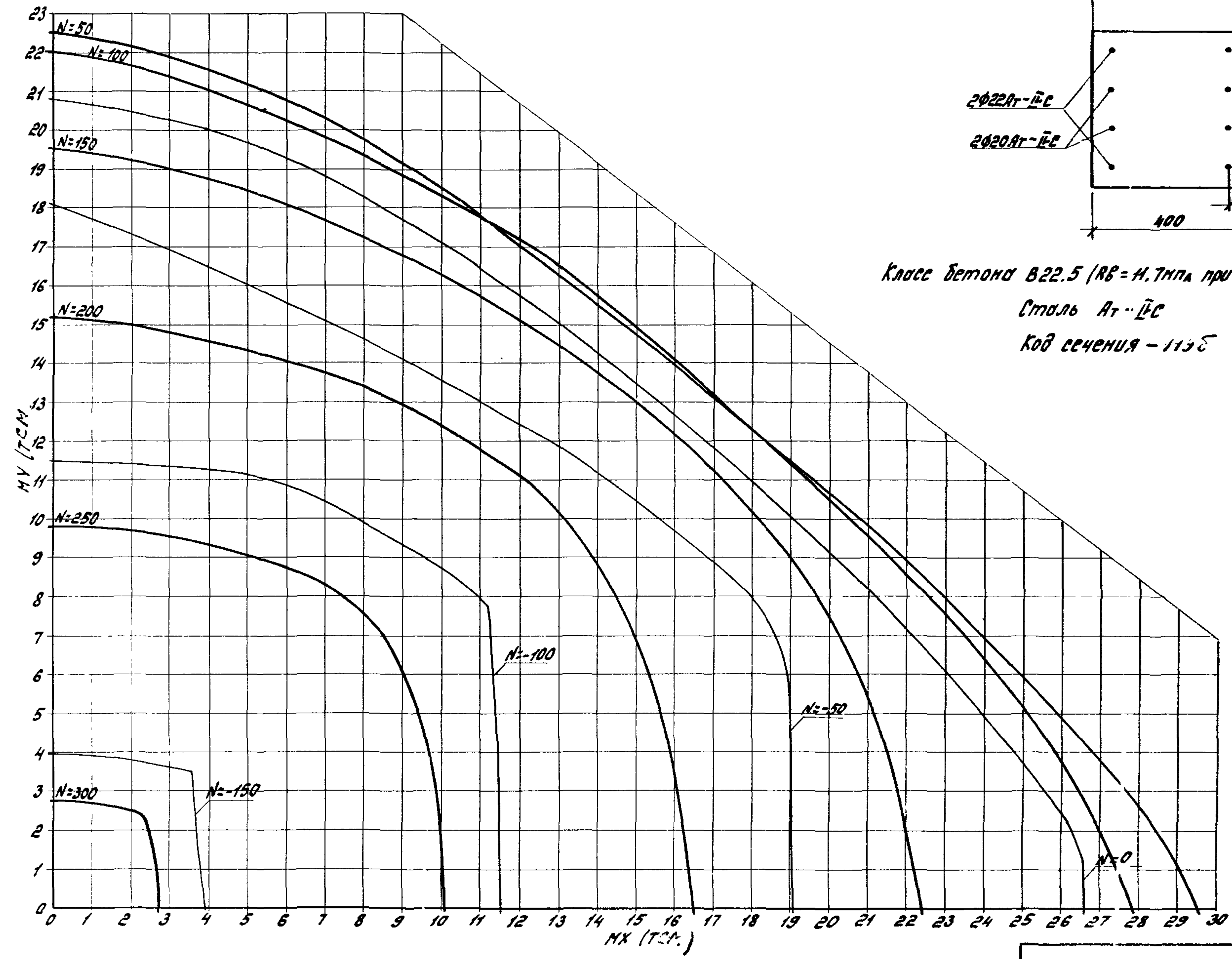

Класс бетона В22.5 ($R_B = 11.7 \text{ МПа}$ при учёте $\gamma_{B2} = 0.90$)
 Сталь Ат-ІІС
 Код сечения - 113Б

1.020.1-4 0-9 002

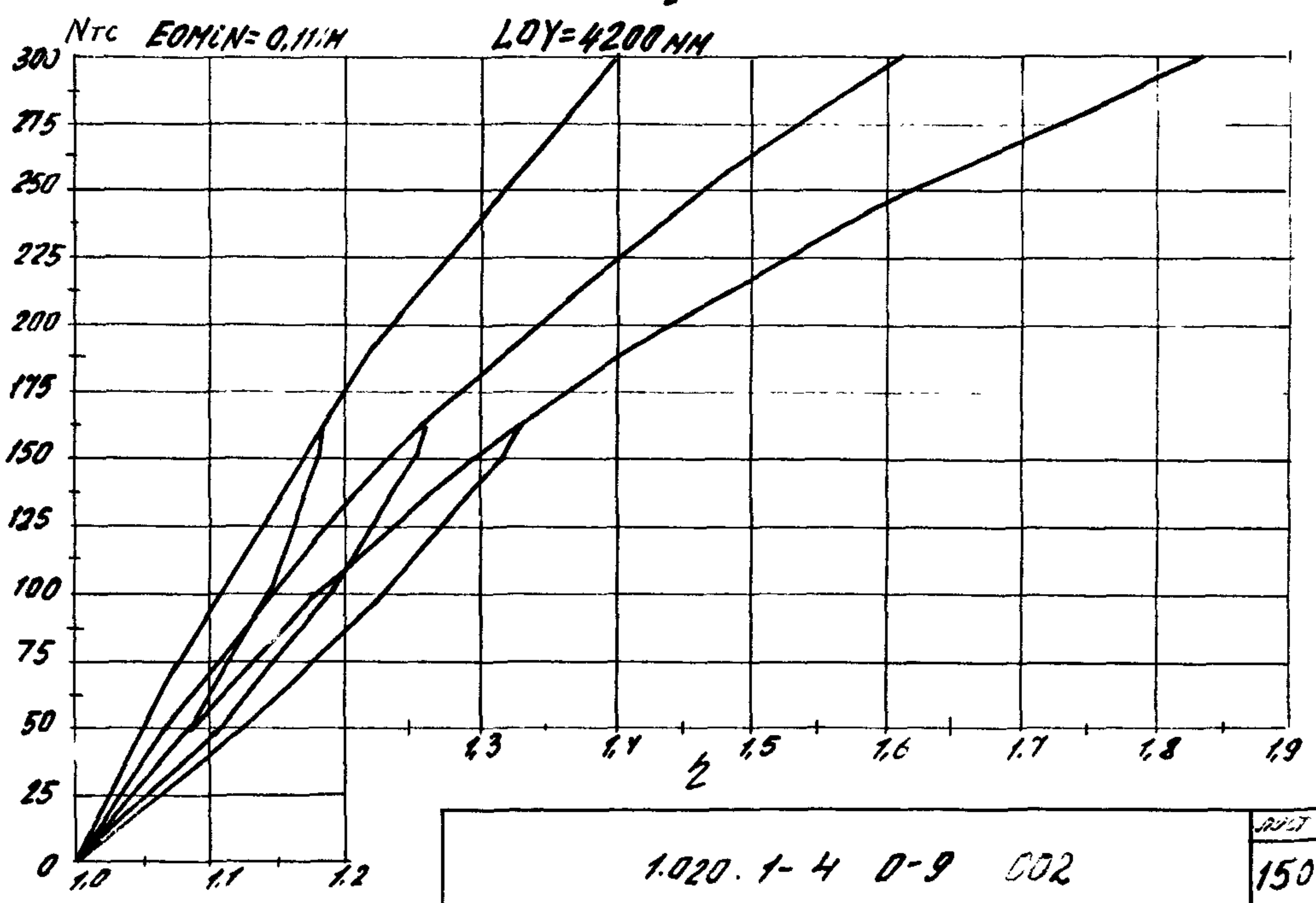
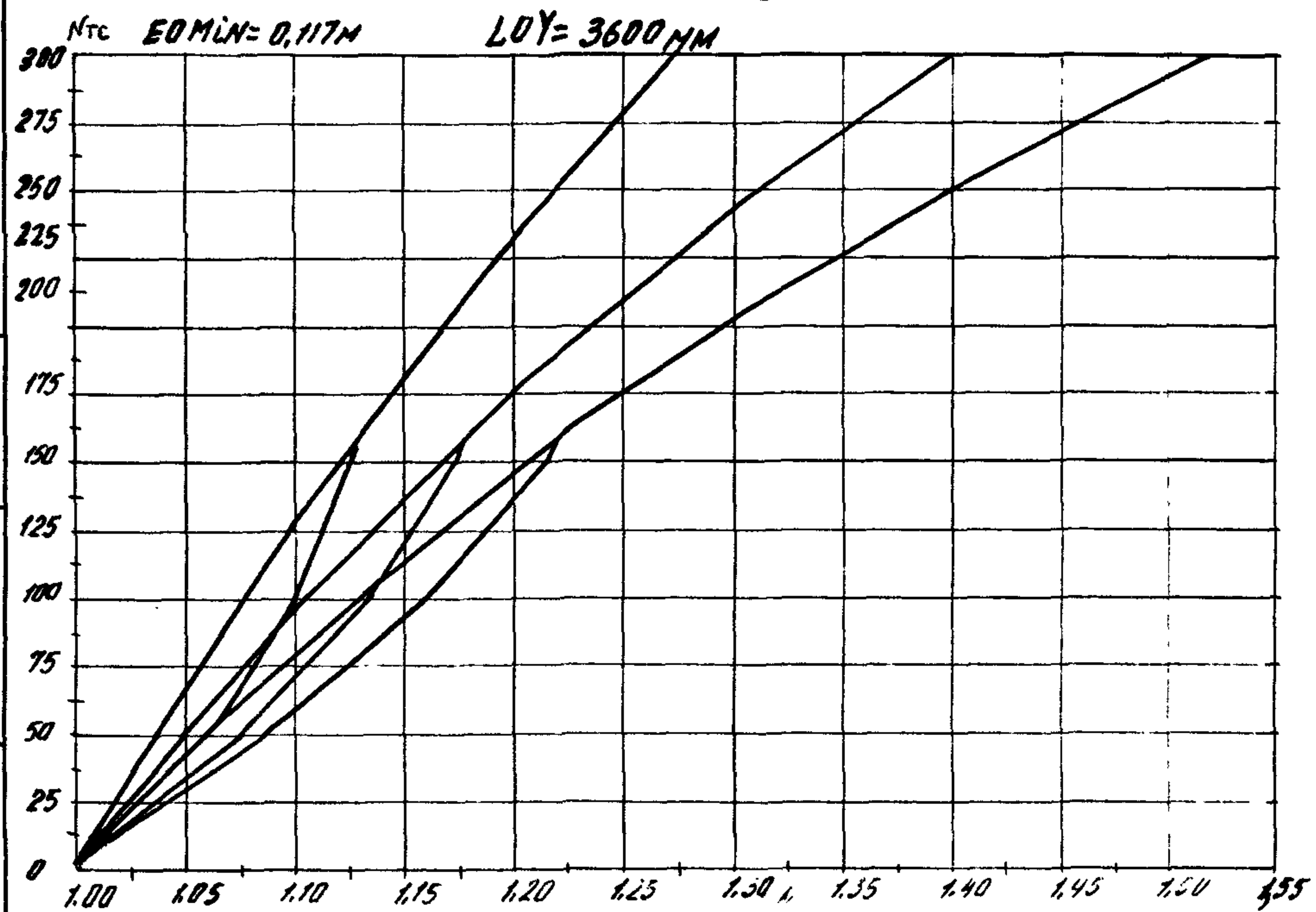
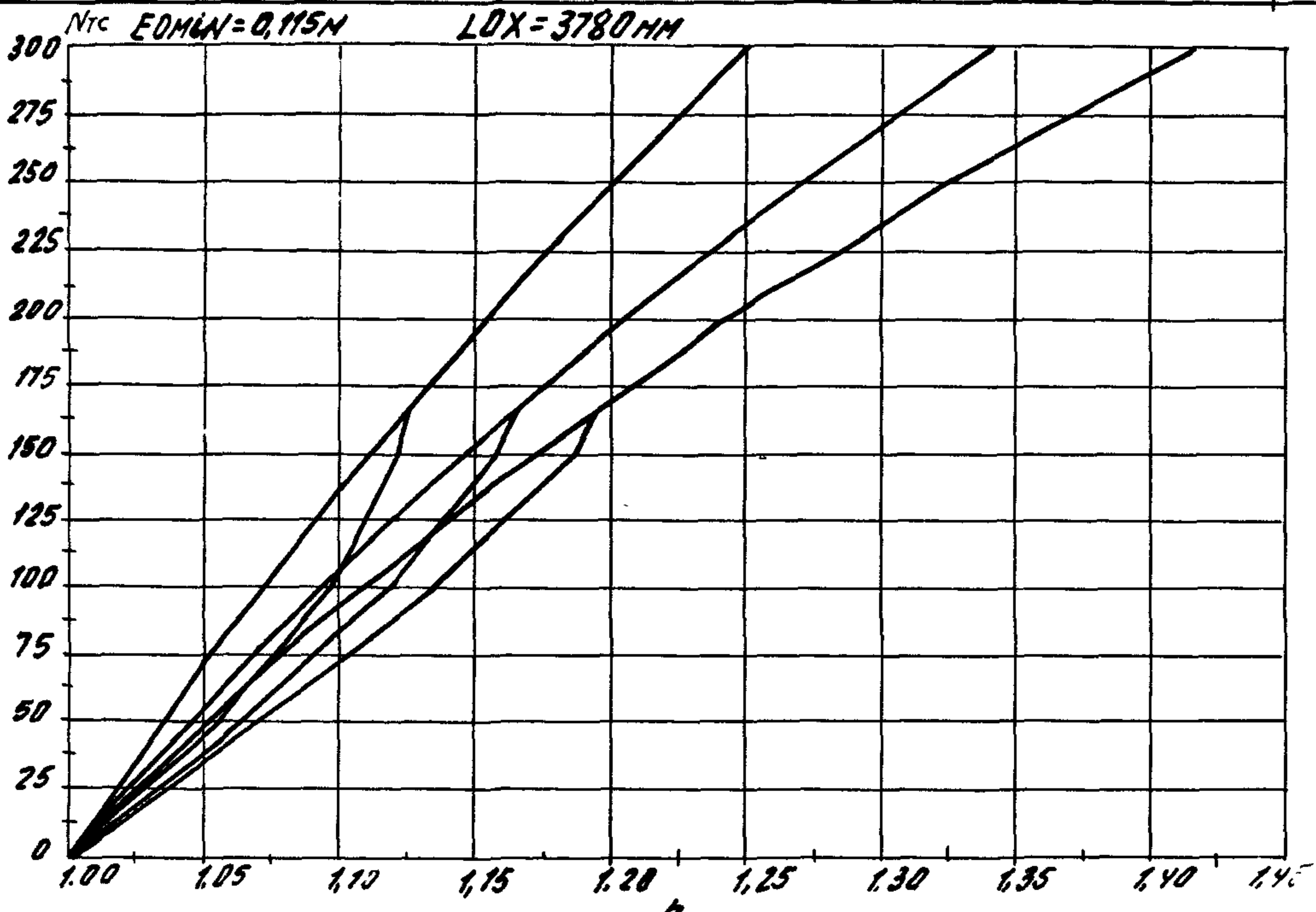
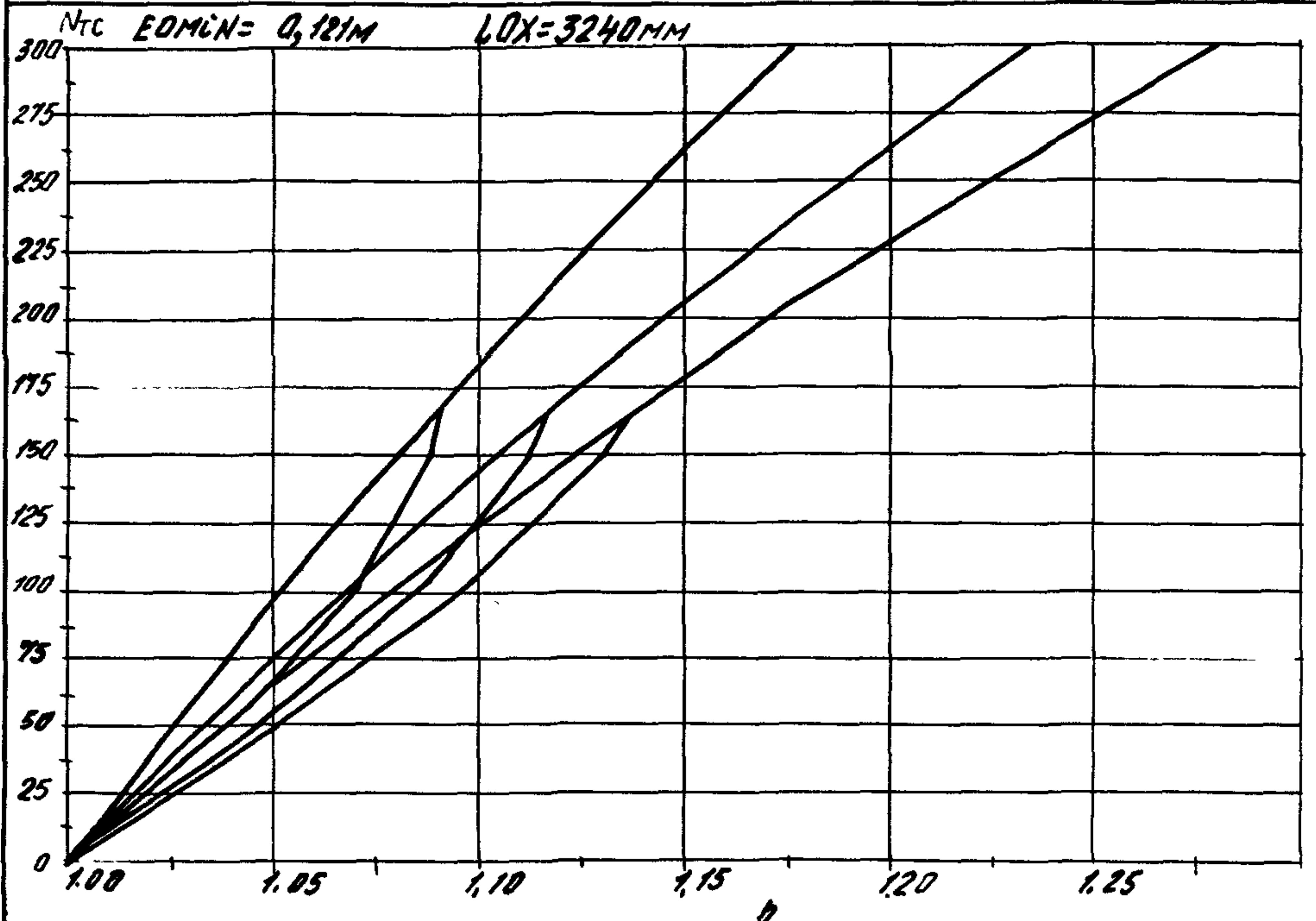

1.020. 1-4 0-9 002

150

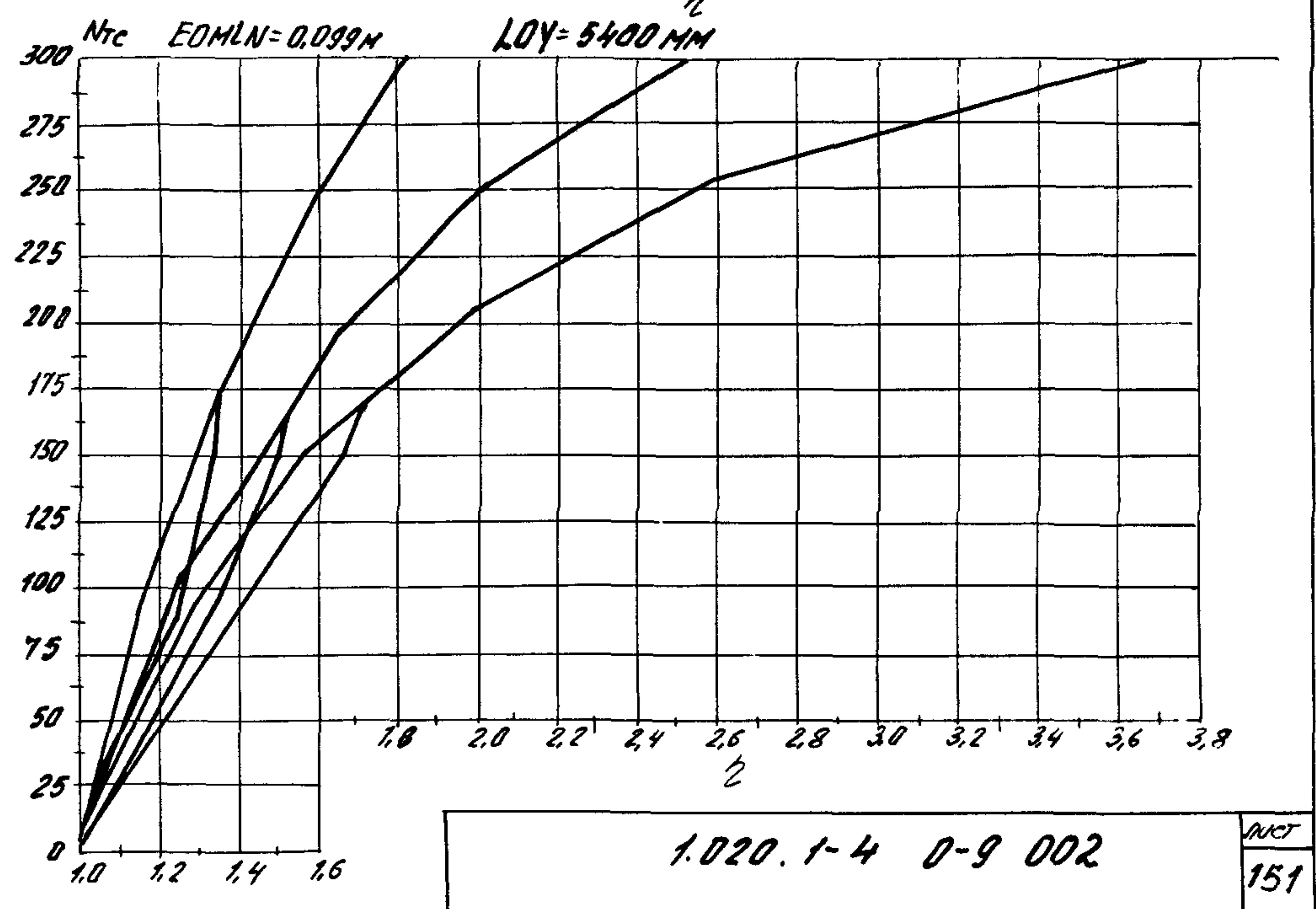
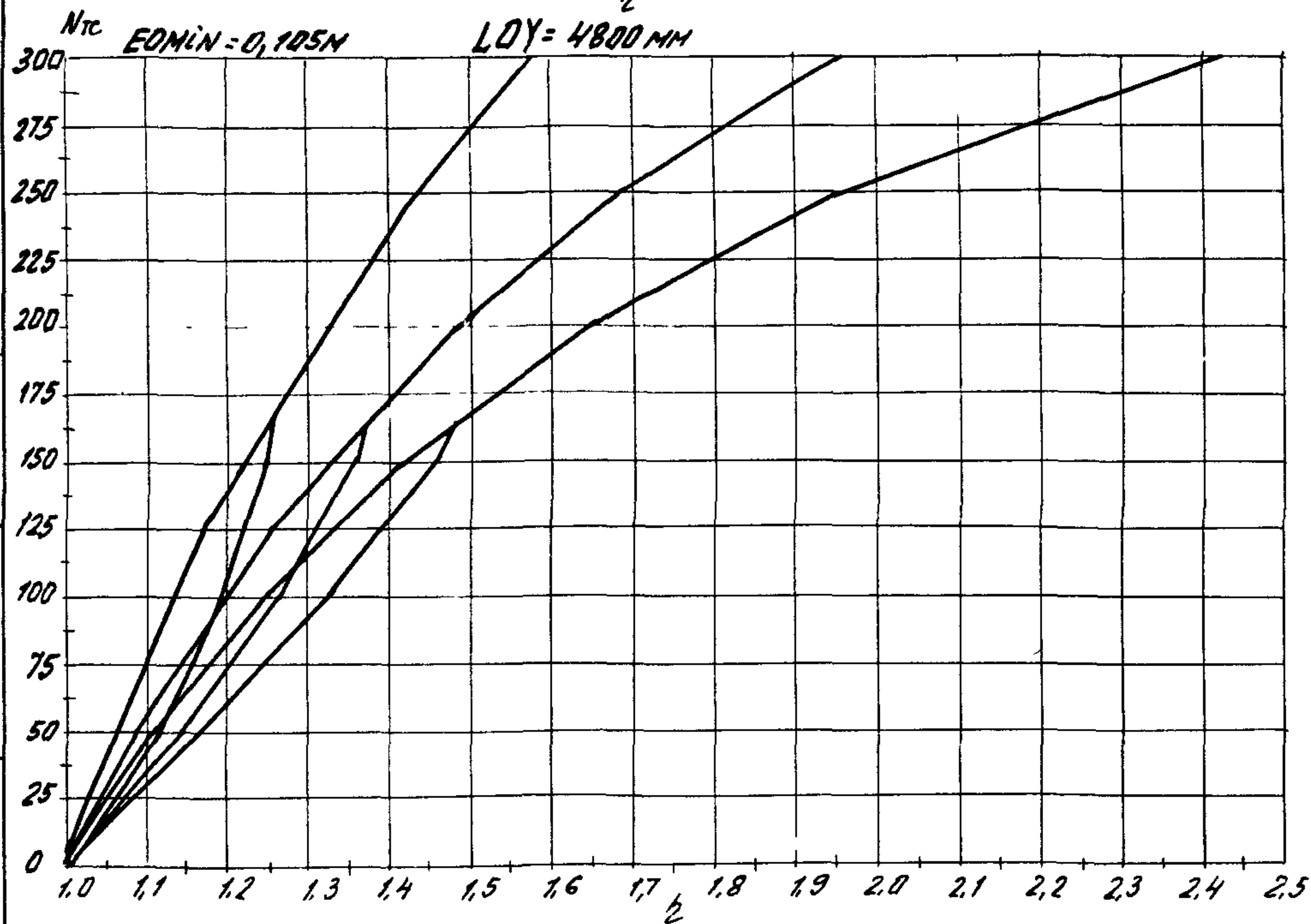
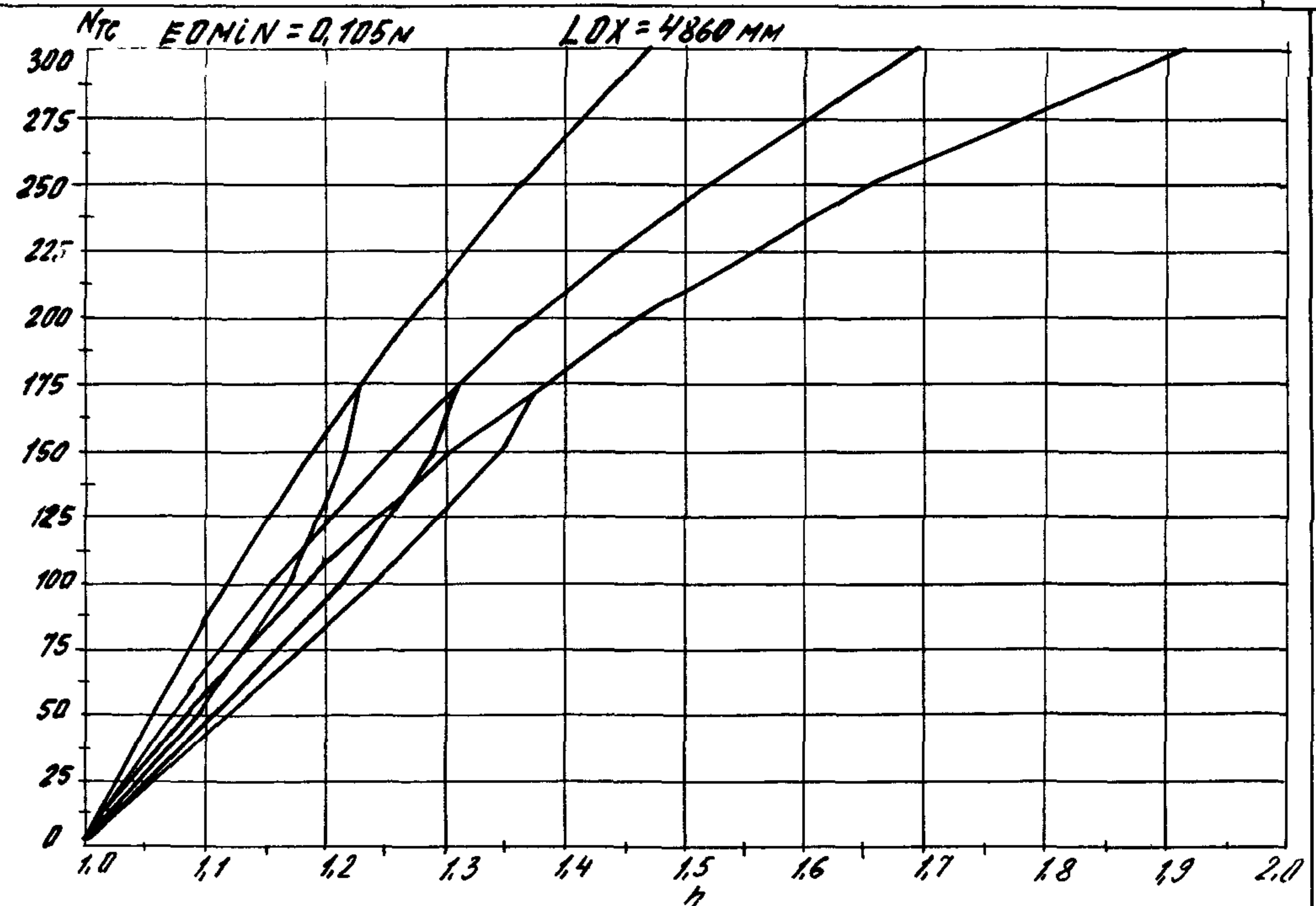
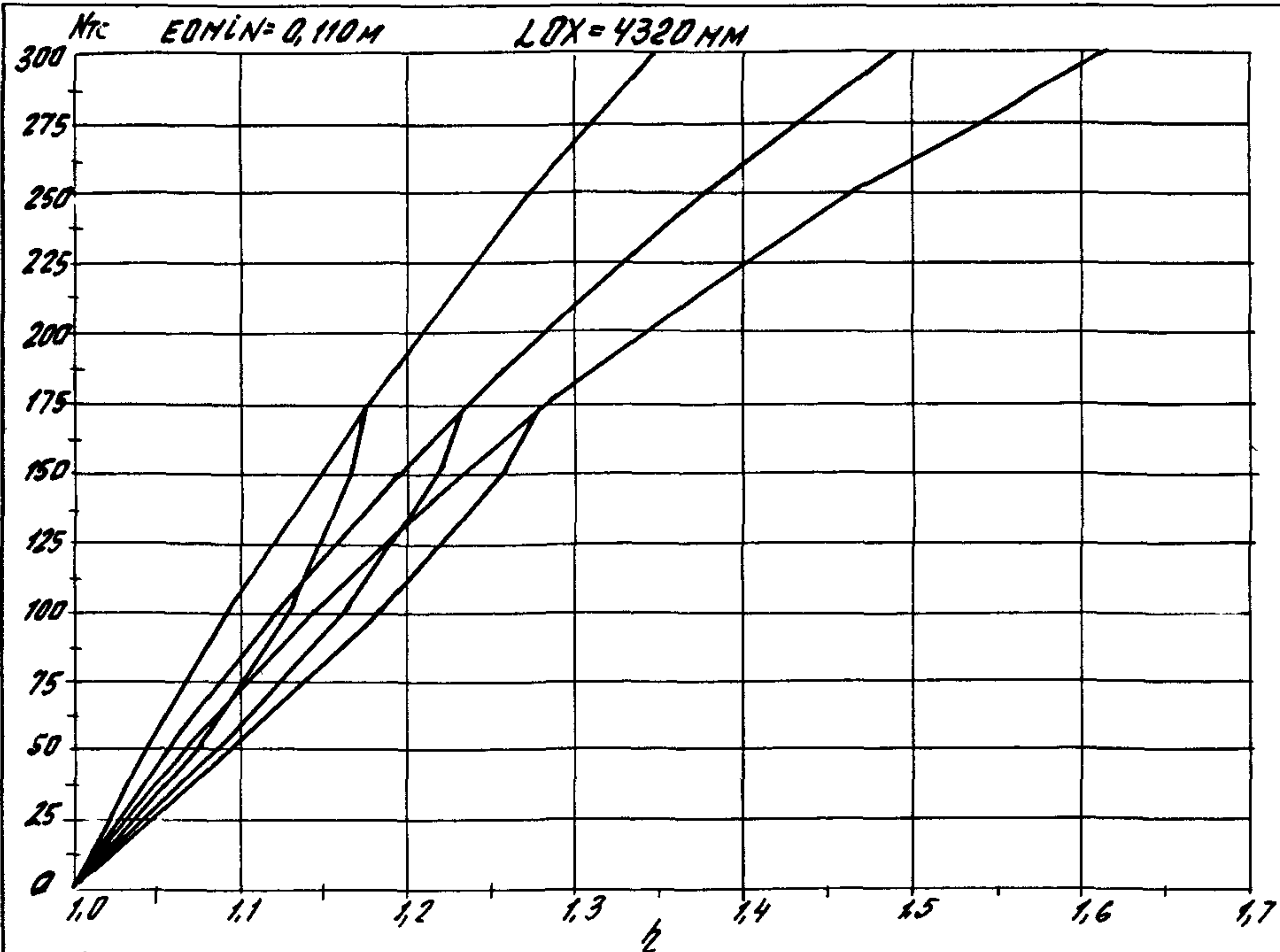

1000-106 U DAIN

1.020.1-4 0-9 002

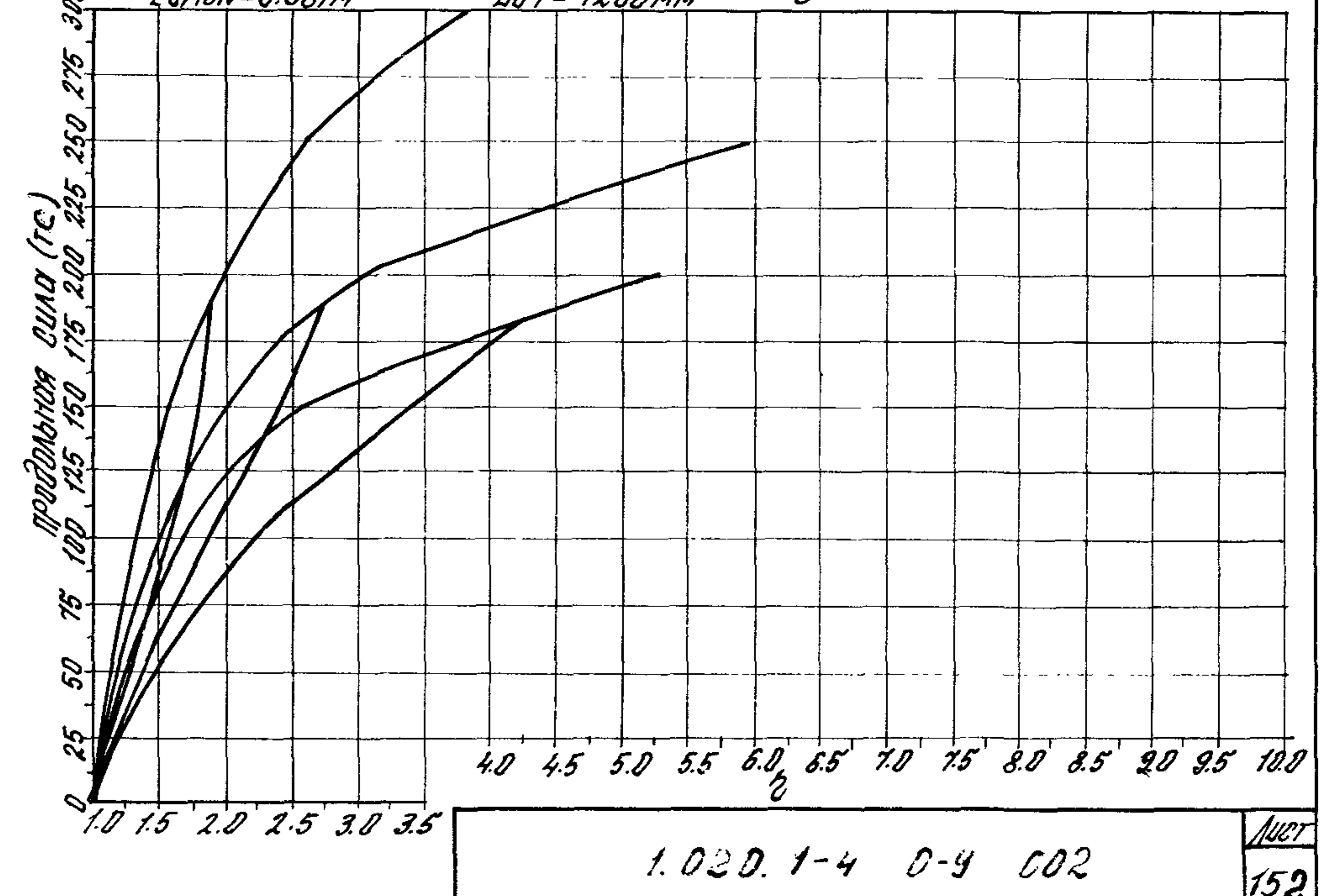
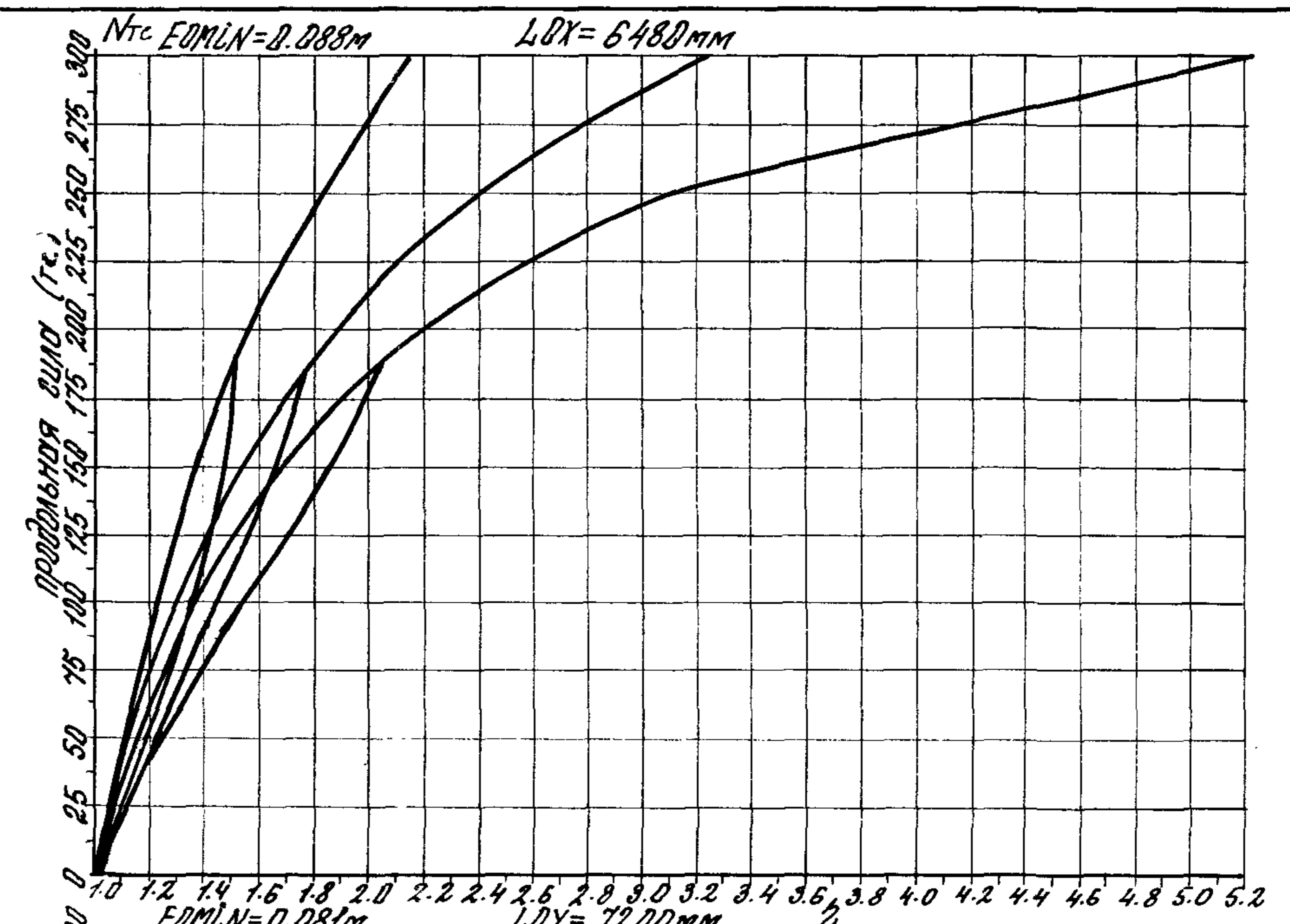
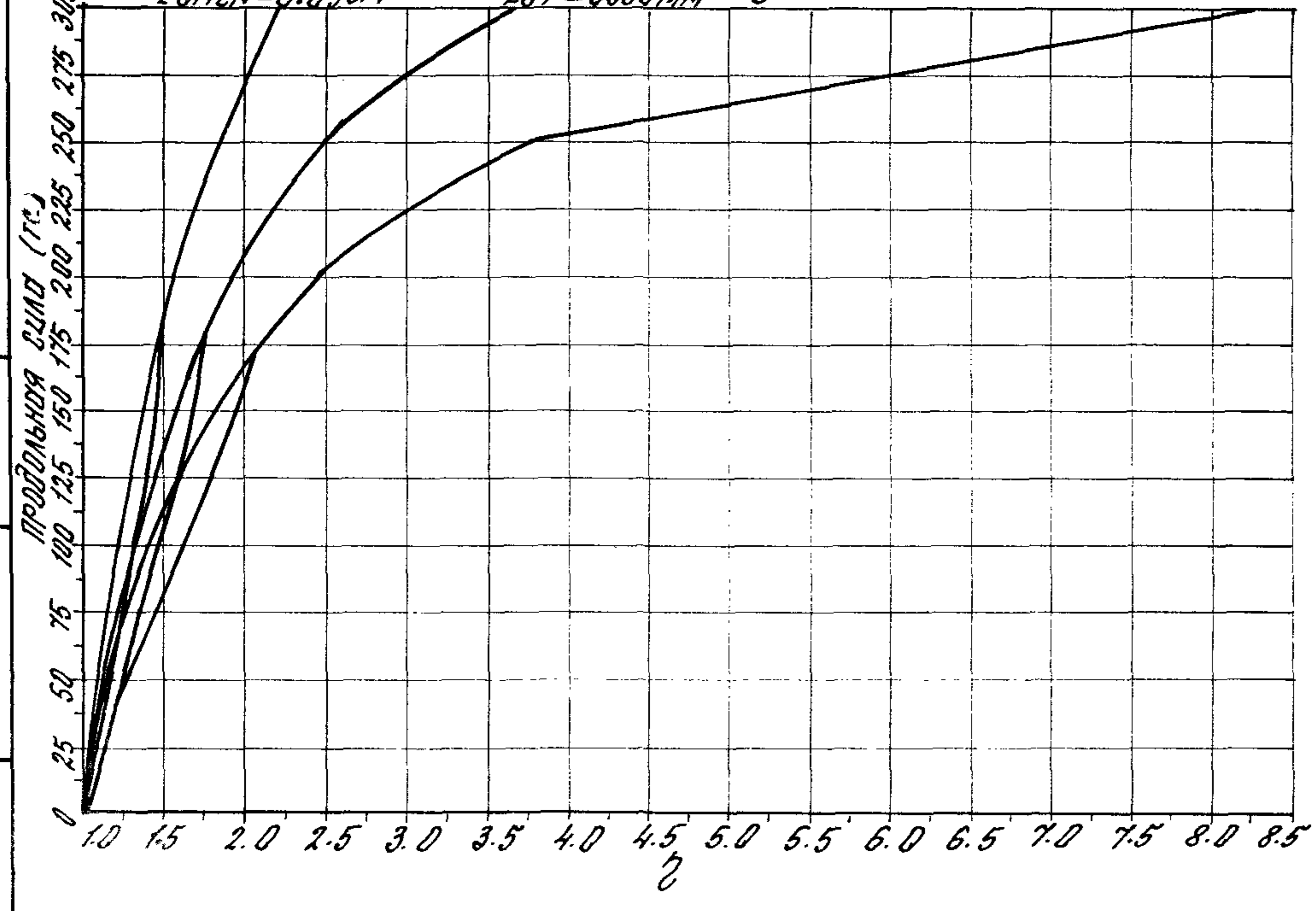
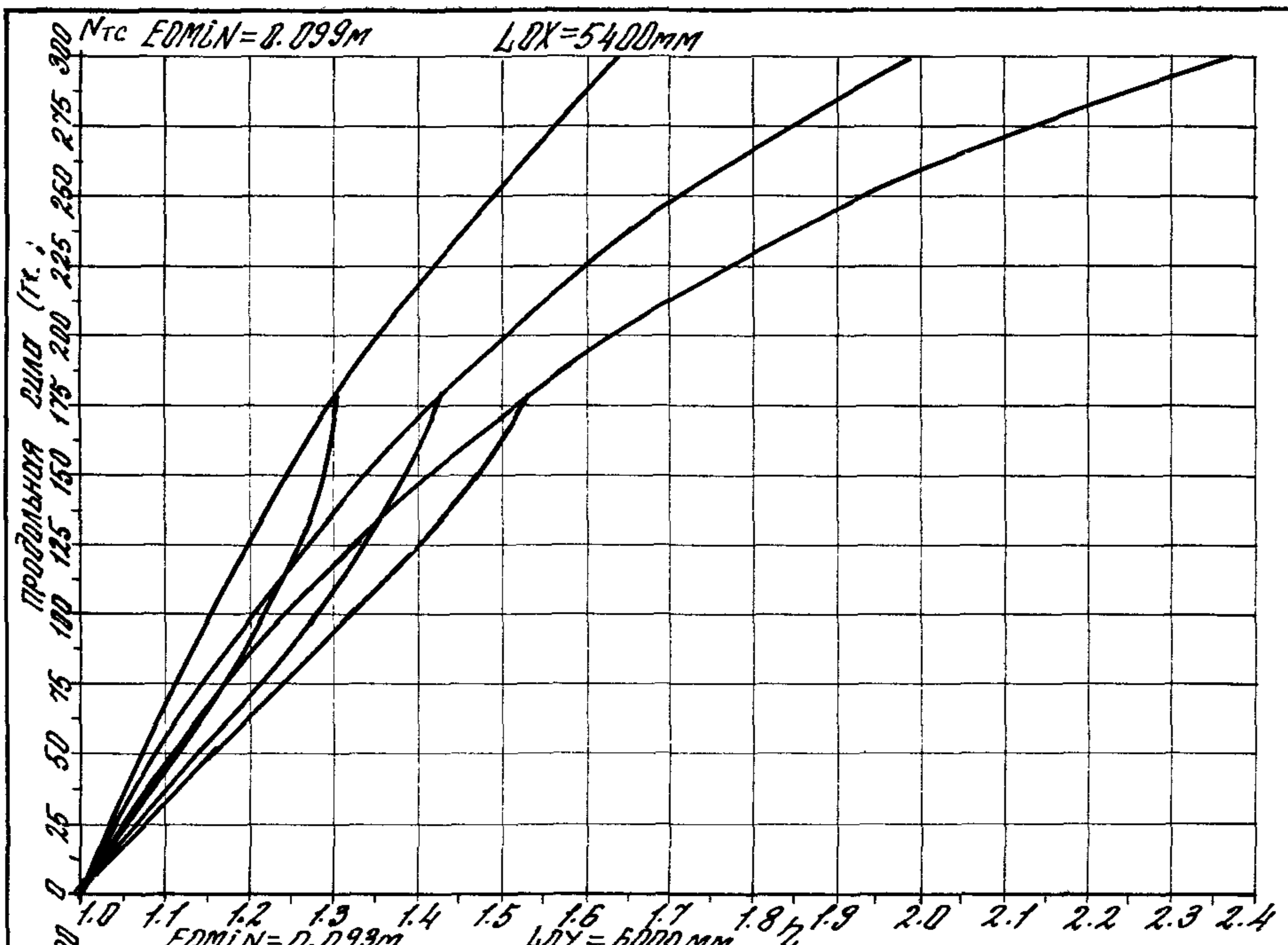

Инд. завод. Госпл. завода

1.020.1-4 0-4 002

152

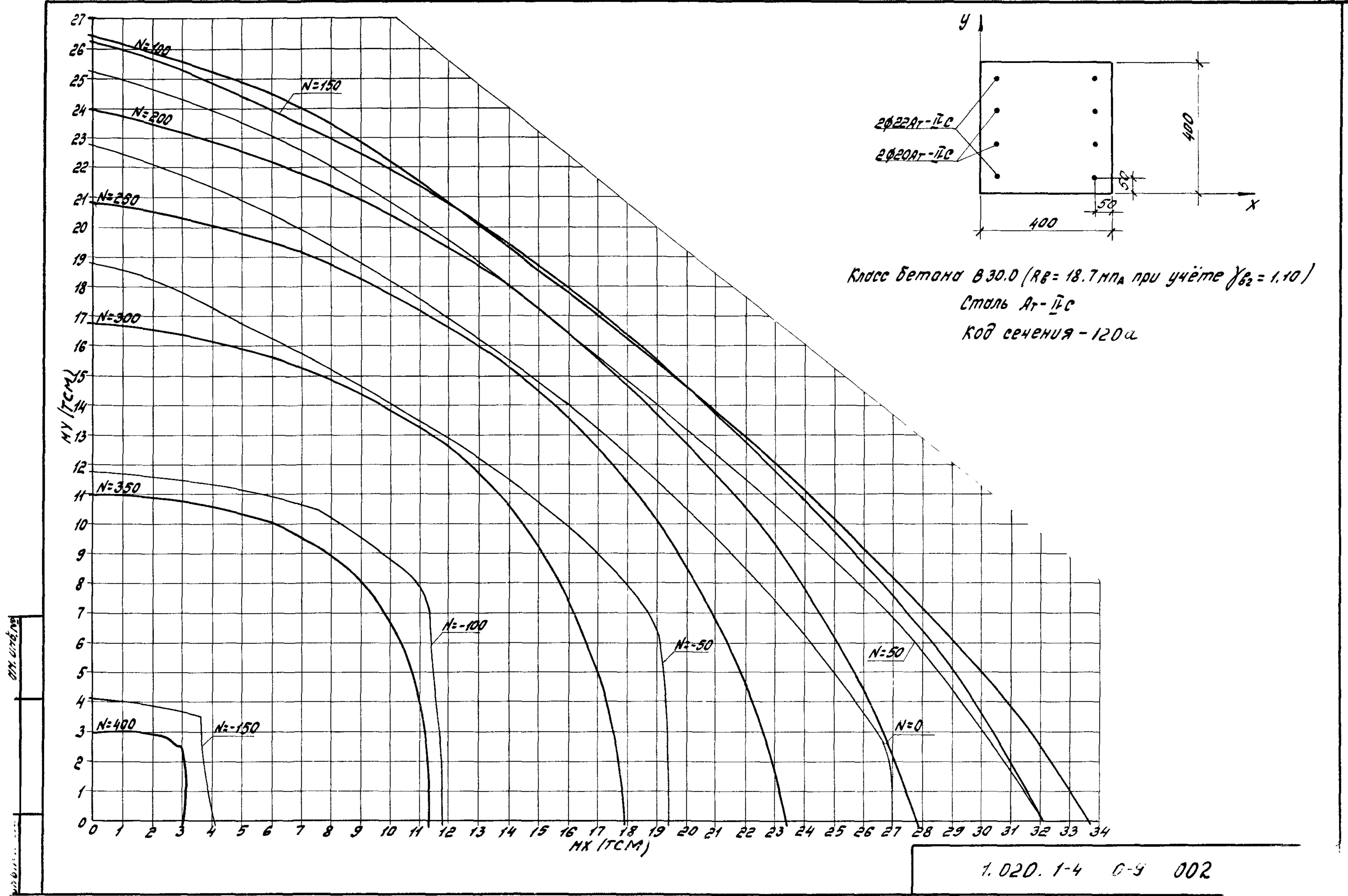

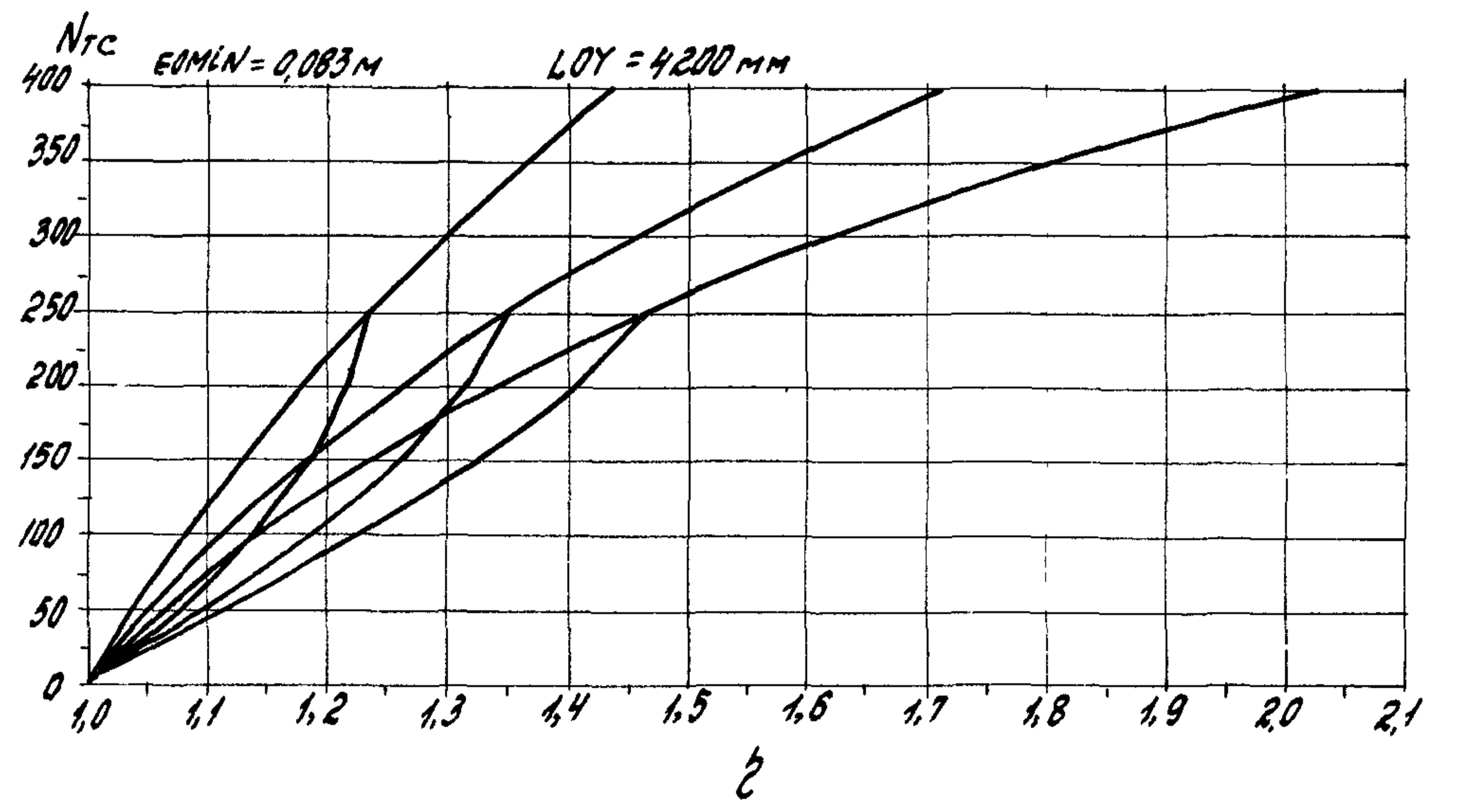
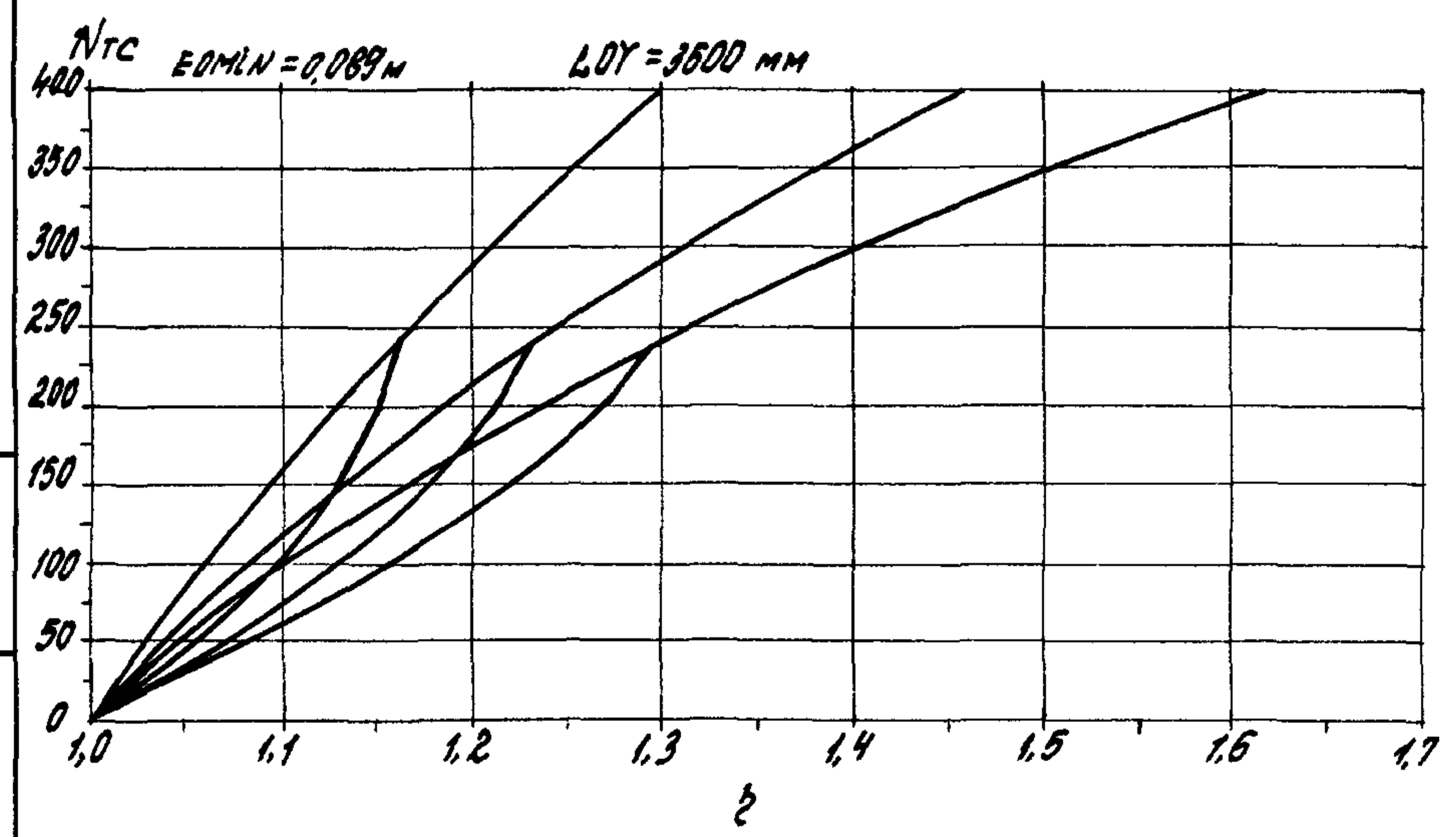
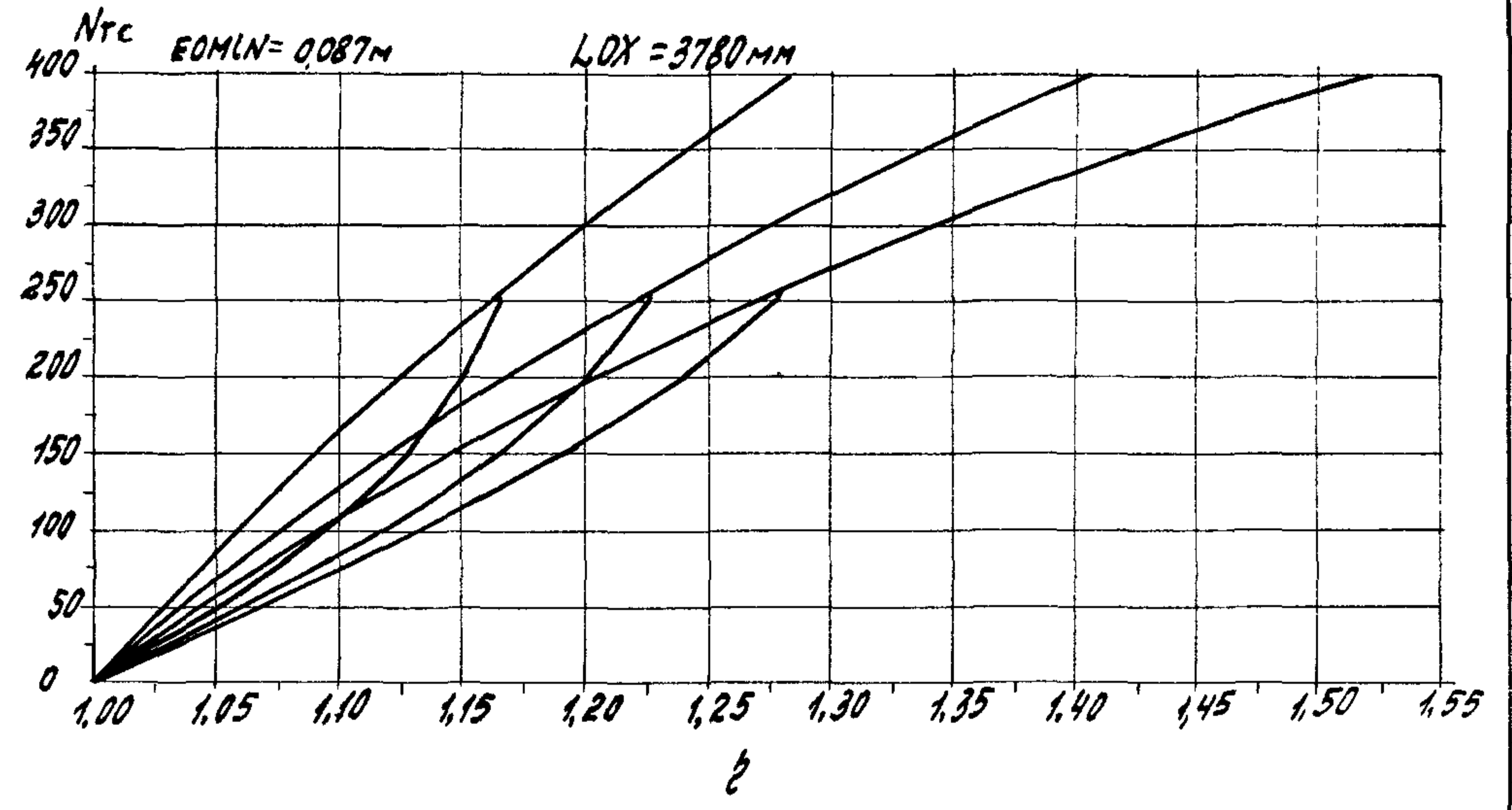
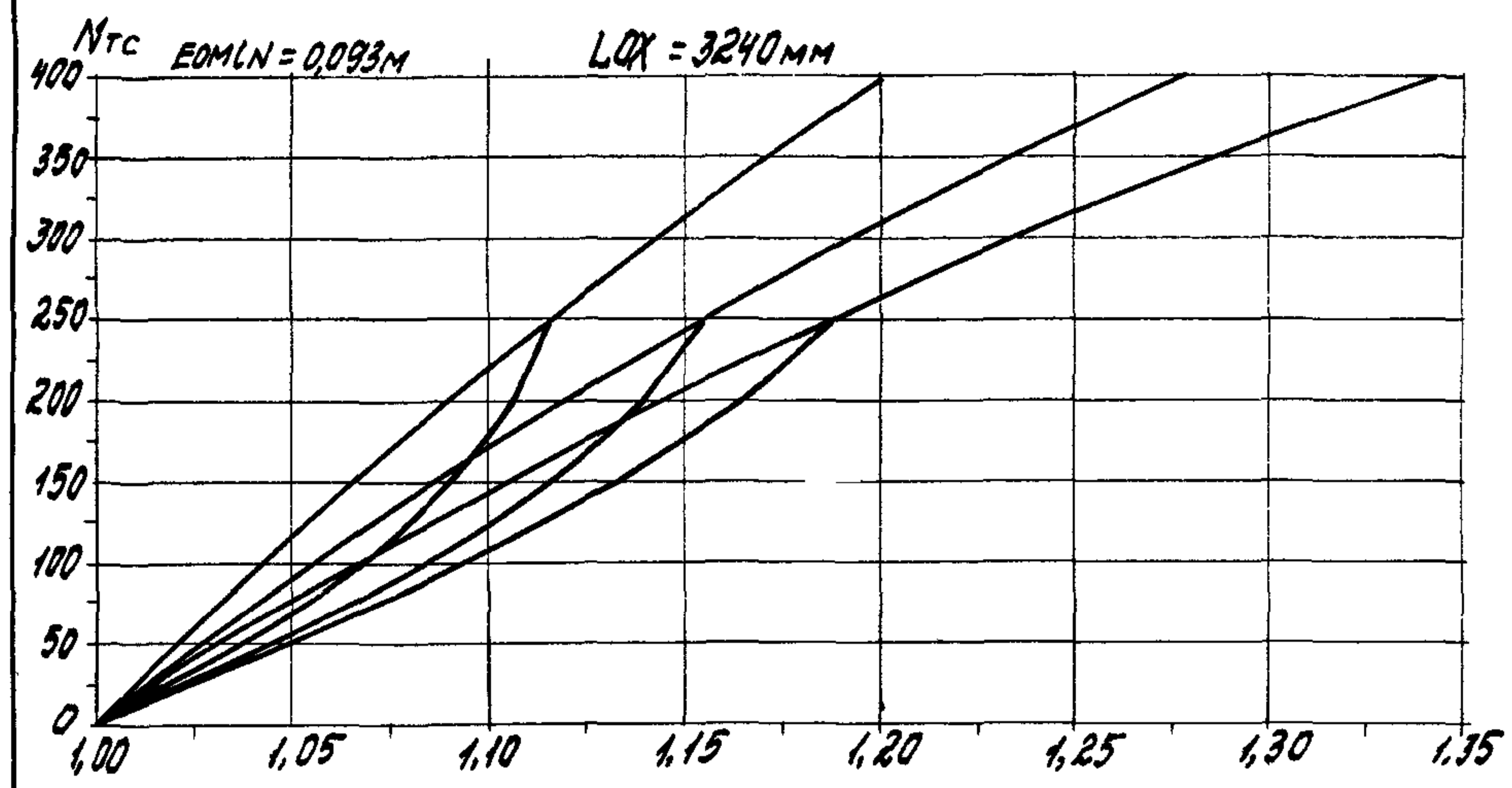

Лист № 154 из 154. Подпись и дата. Взам. инв. №

1.020.1-4 0-9 002 Лист 154

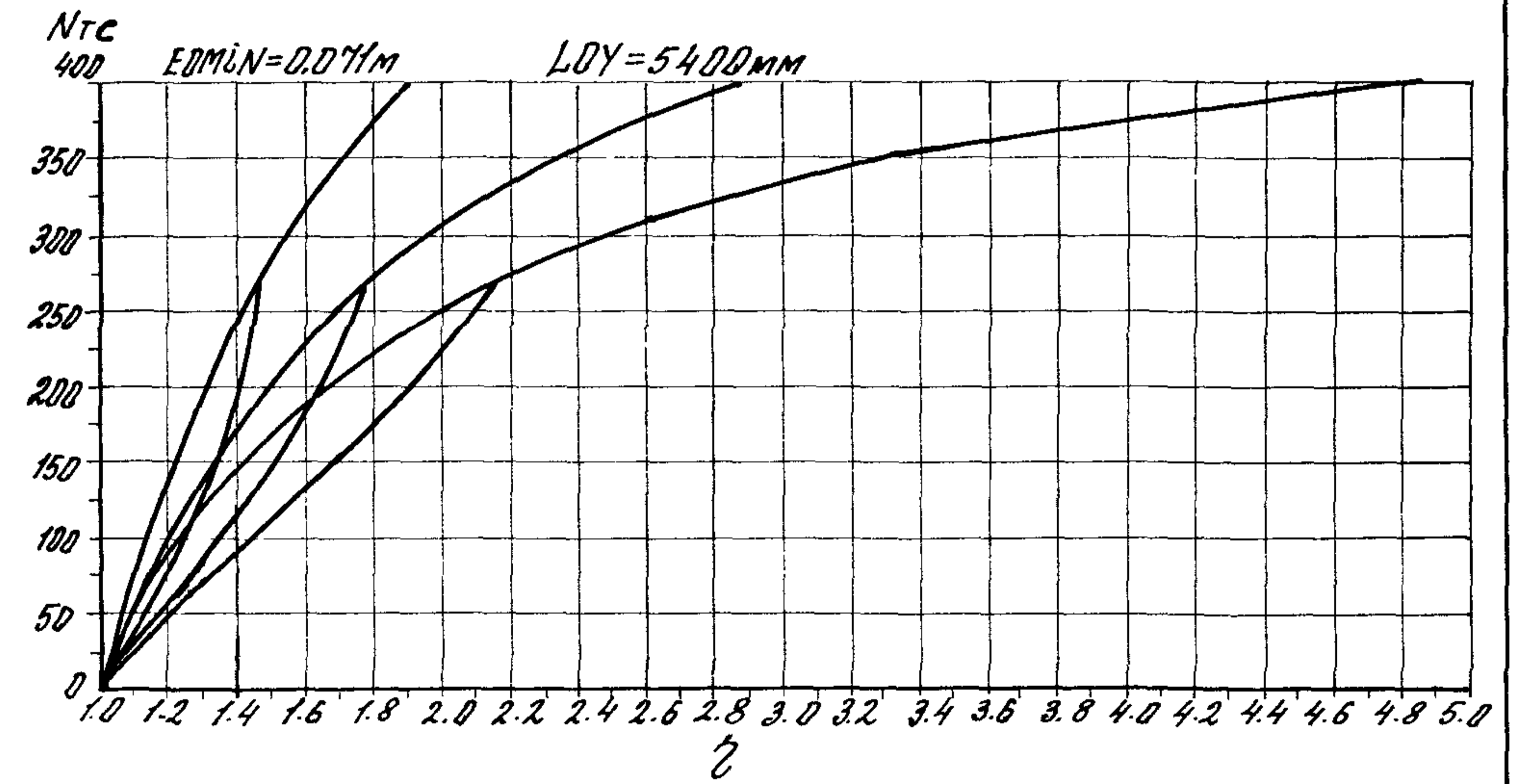
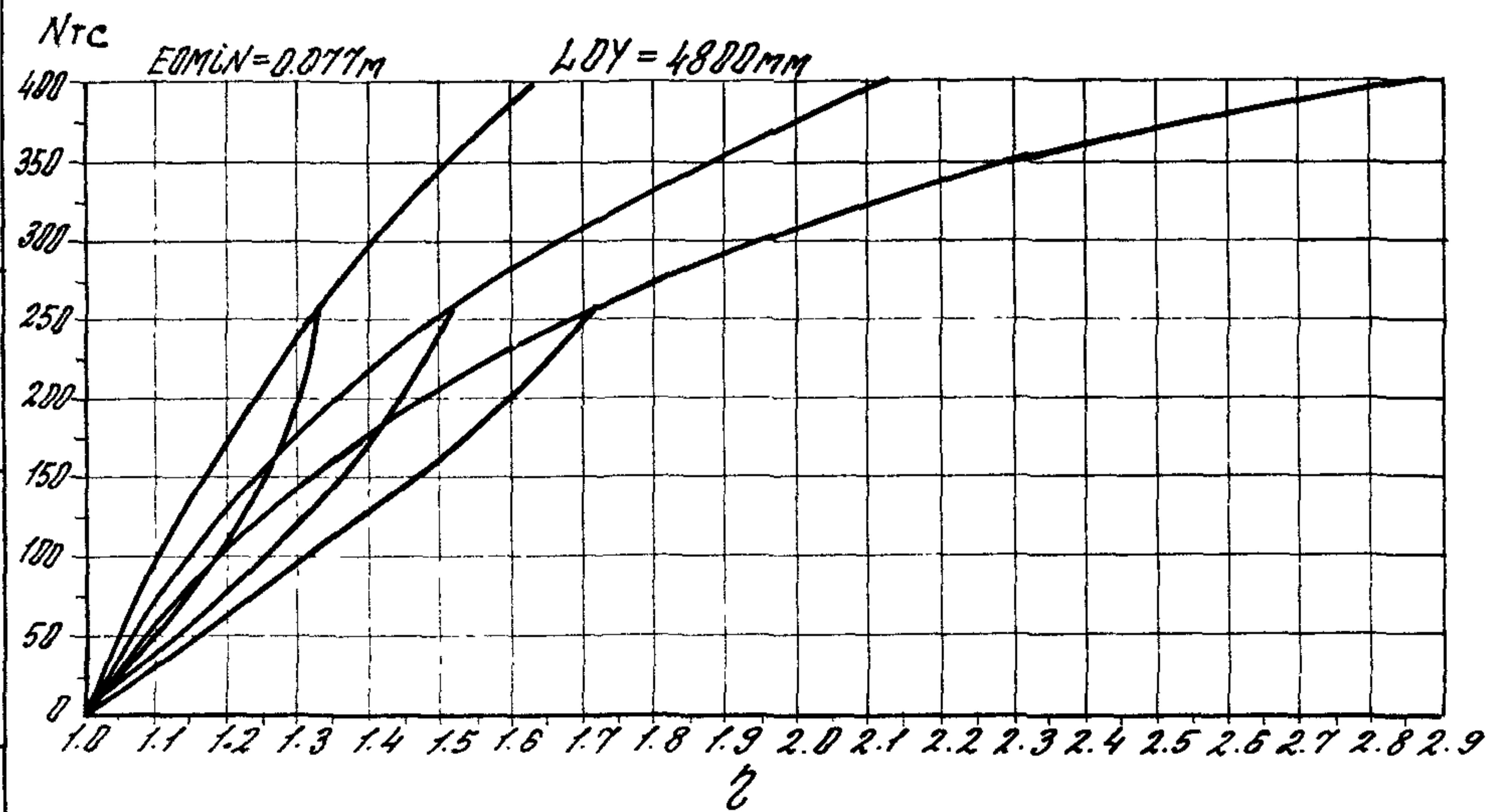
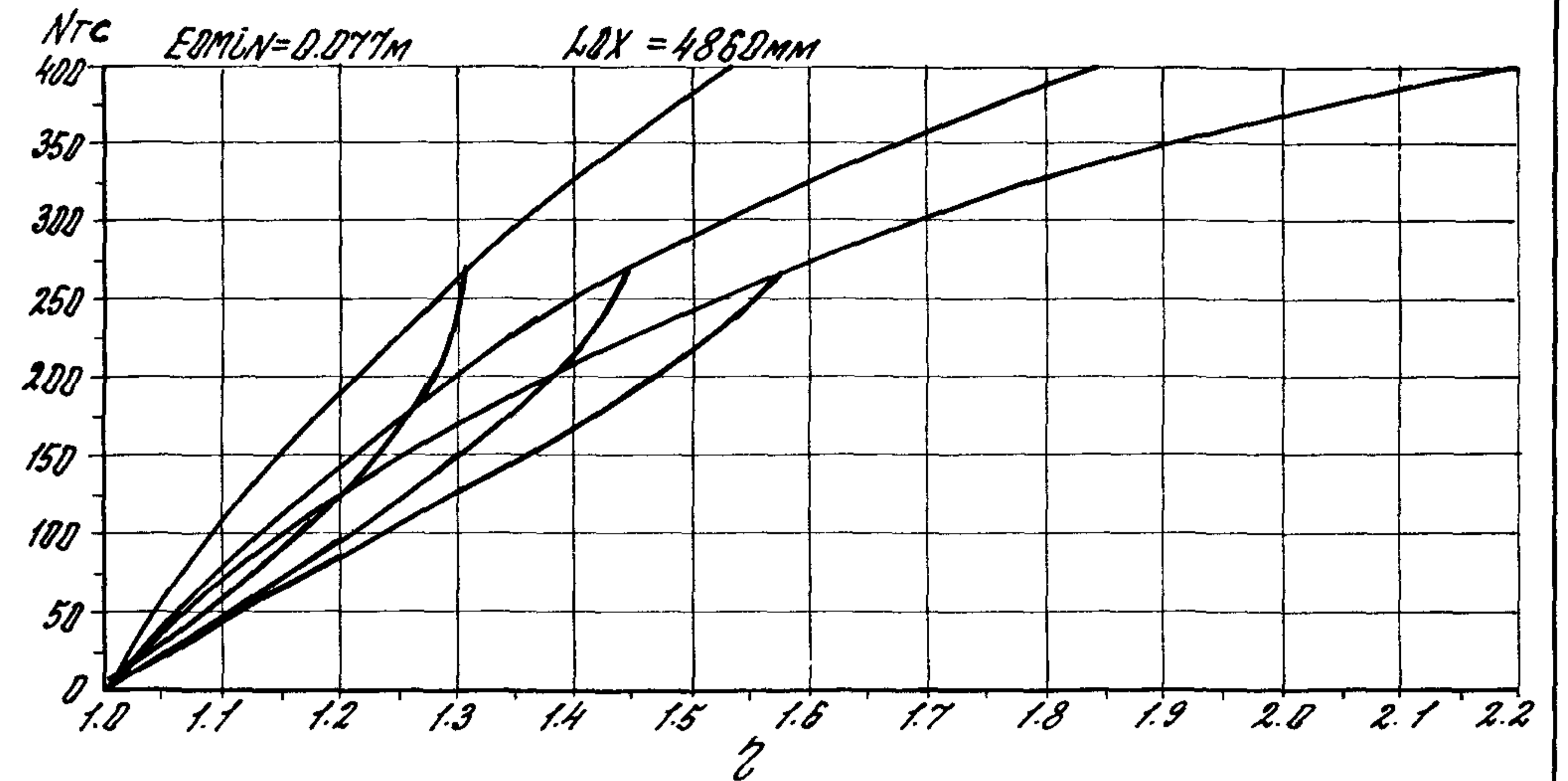
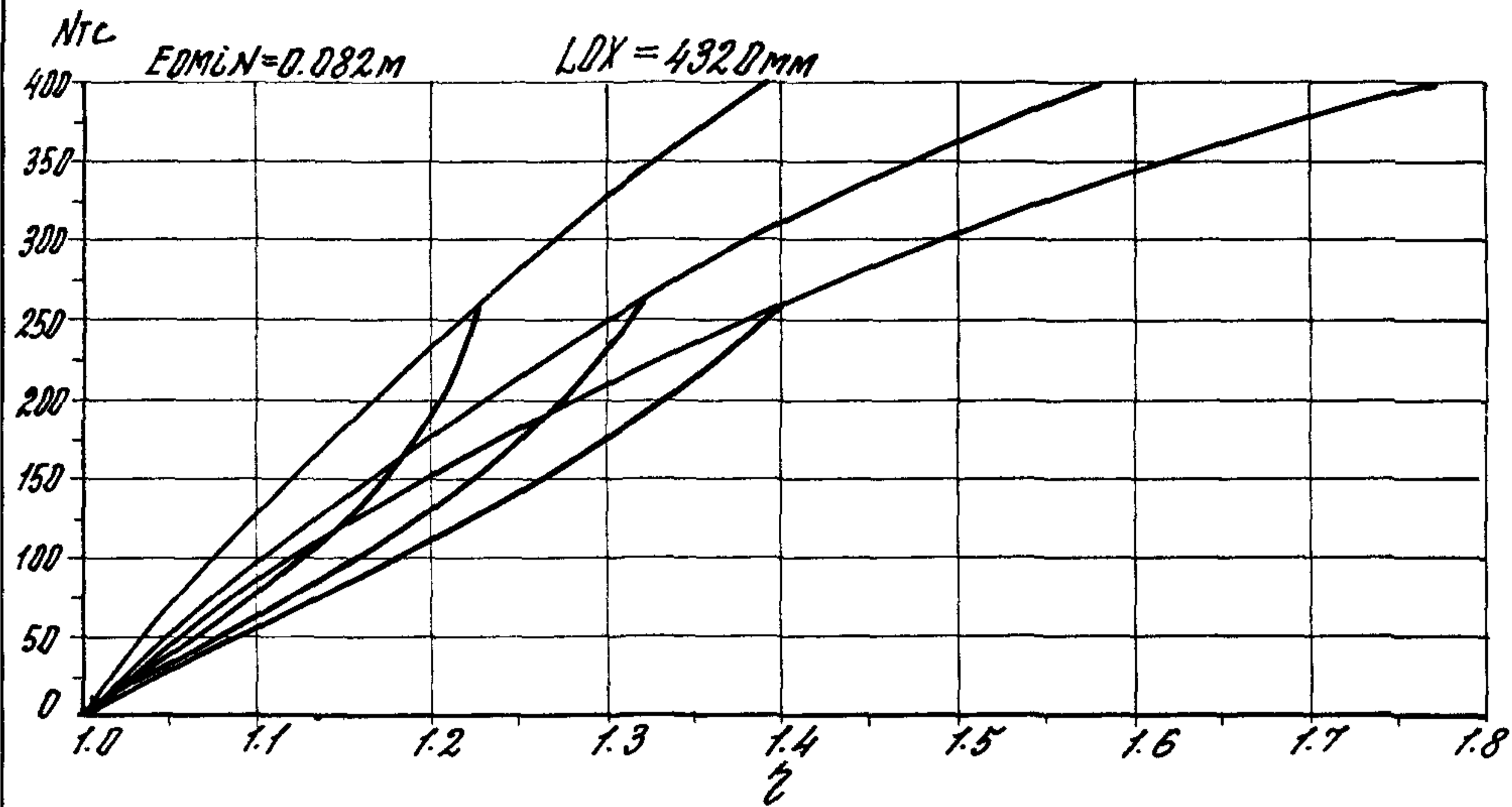

1.023. 1-4 0-9 002

AUGT
155

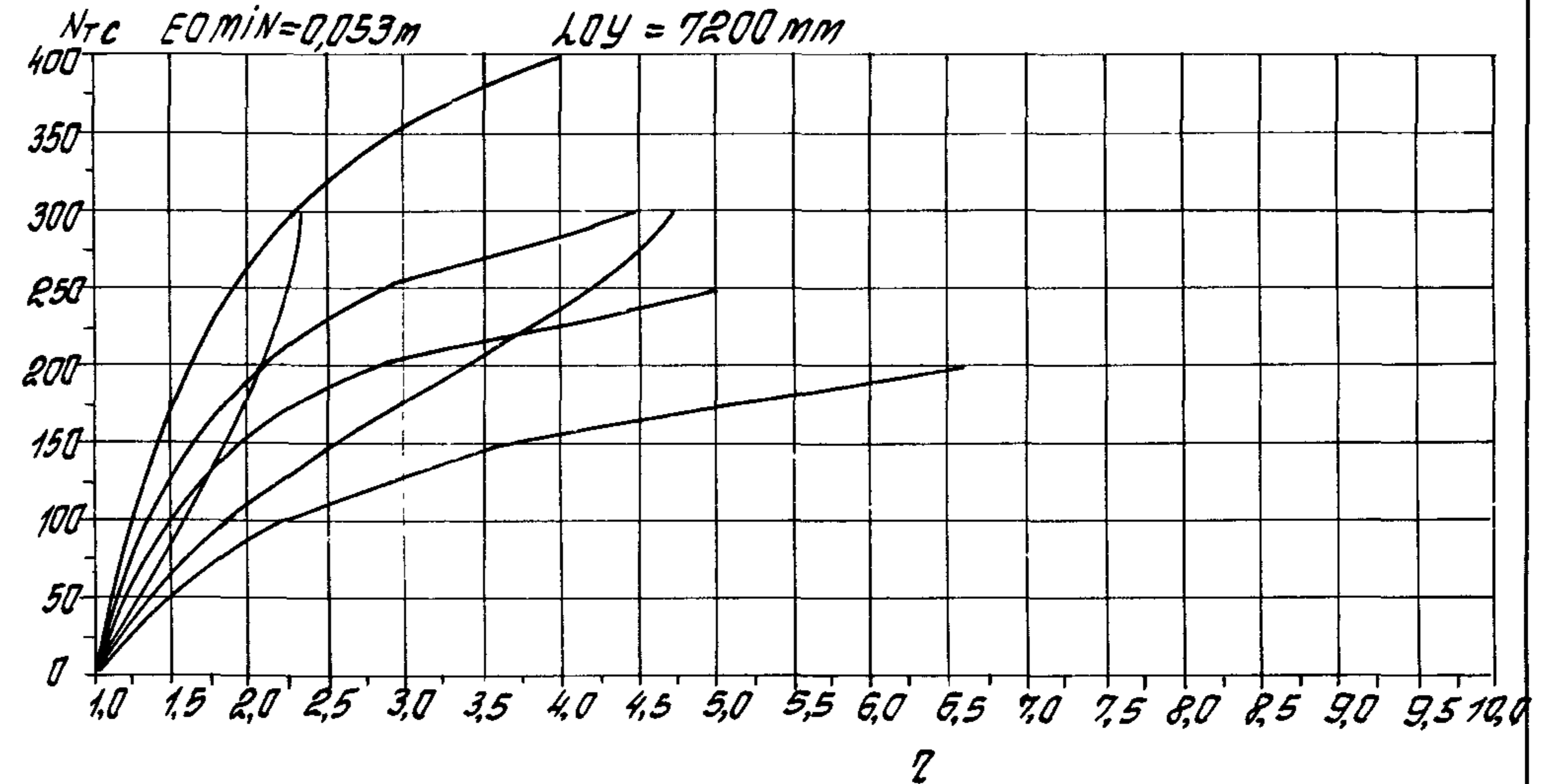
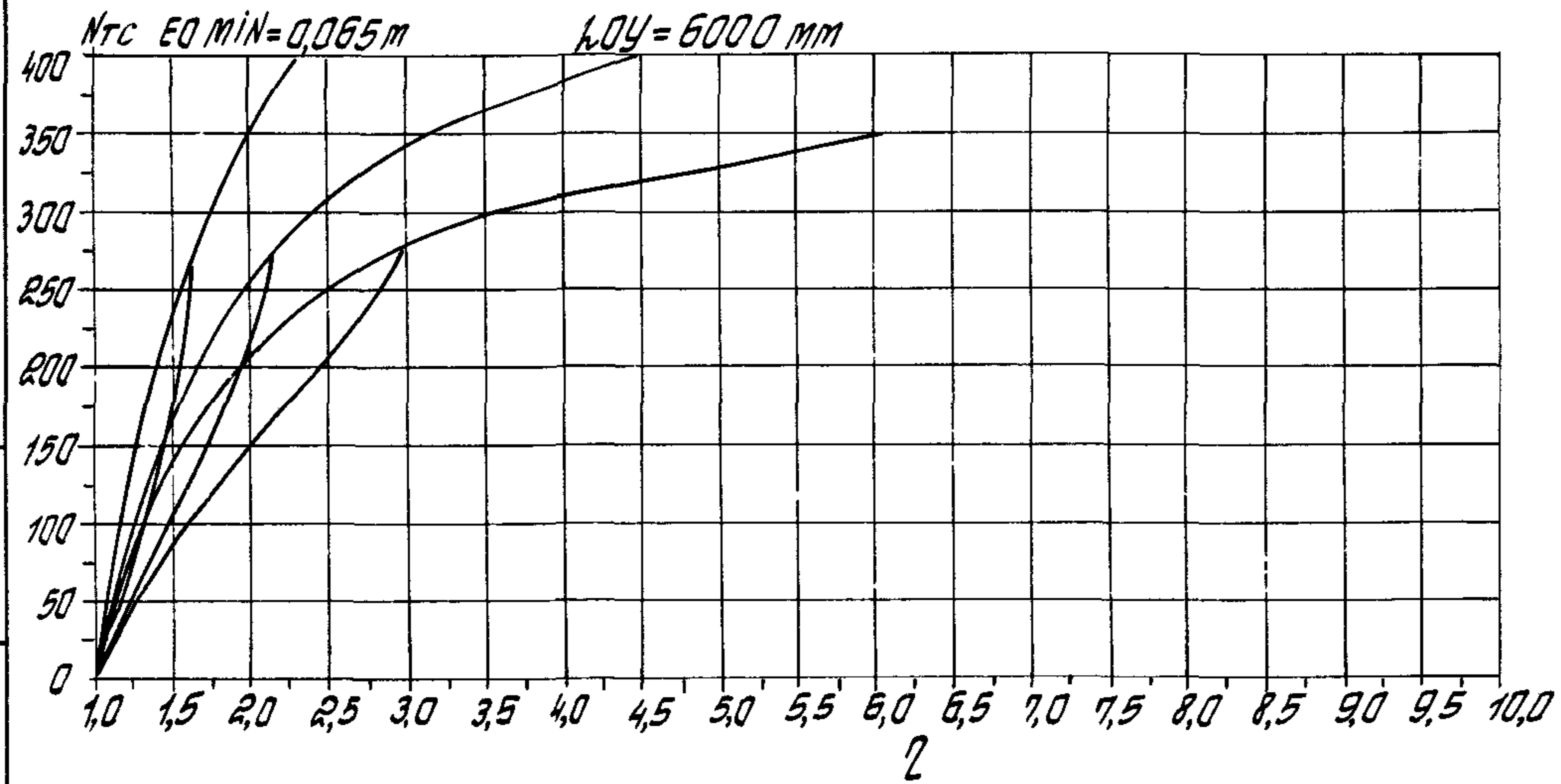
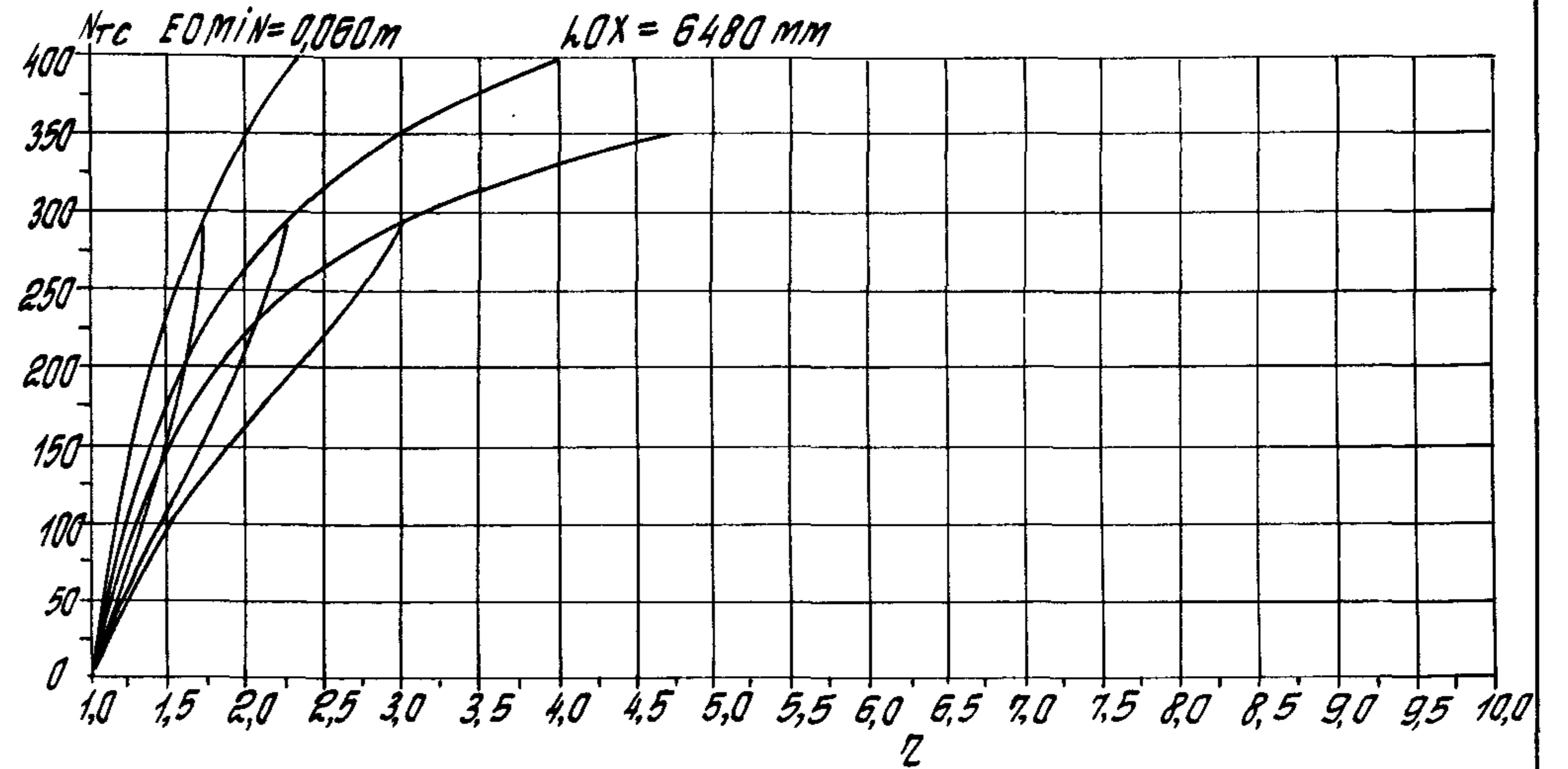
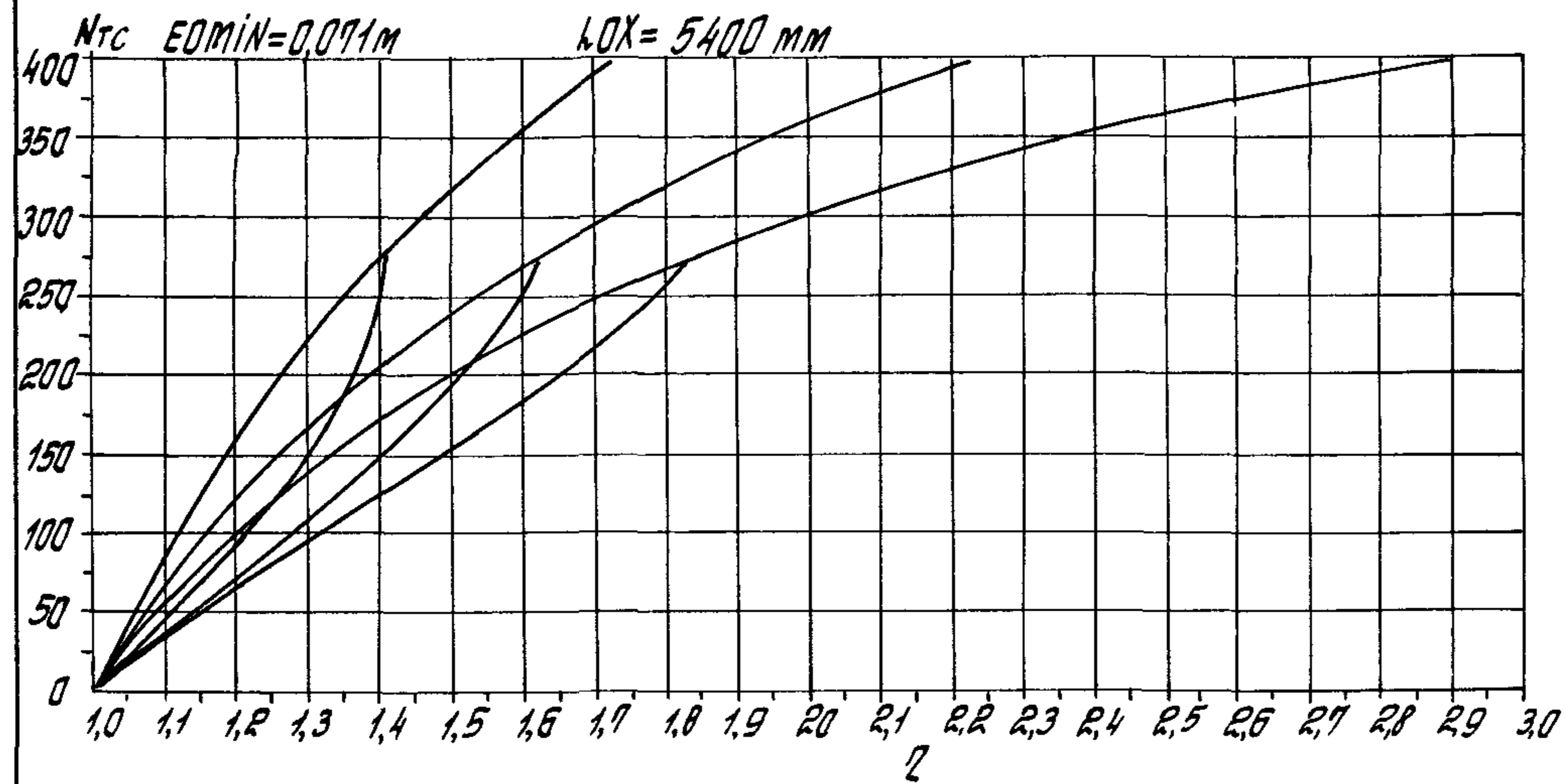

Уч. № подл. Подпись и дата

1.020. 1-4 0-9 002

Лист	156
------	-----

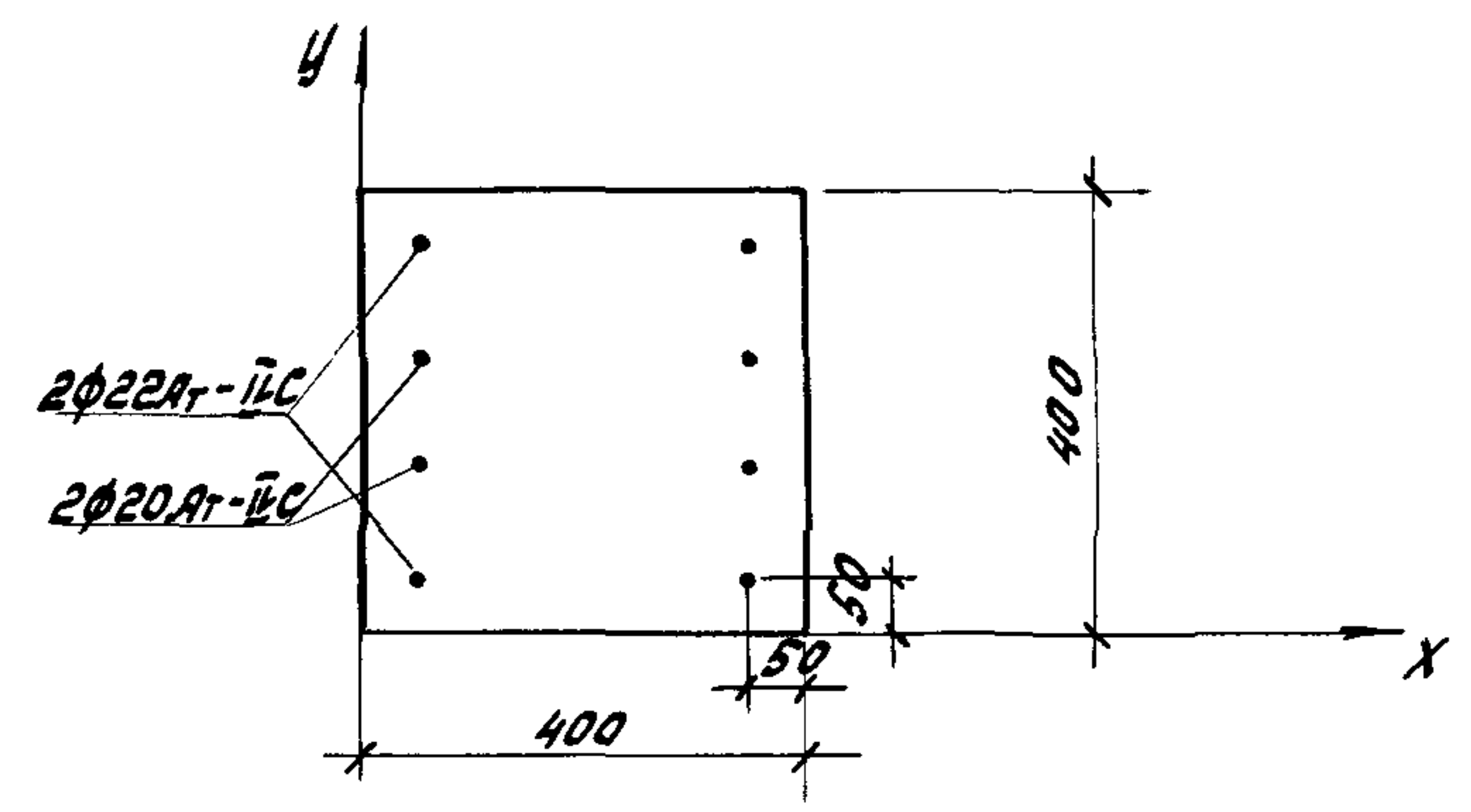
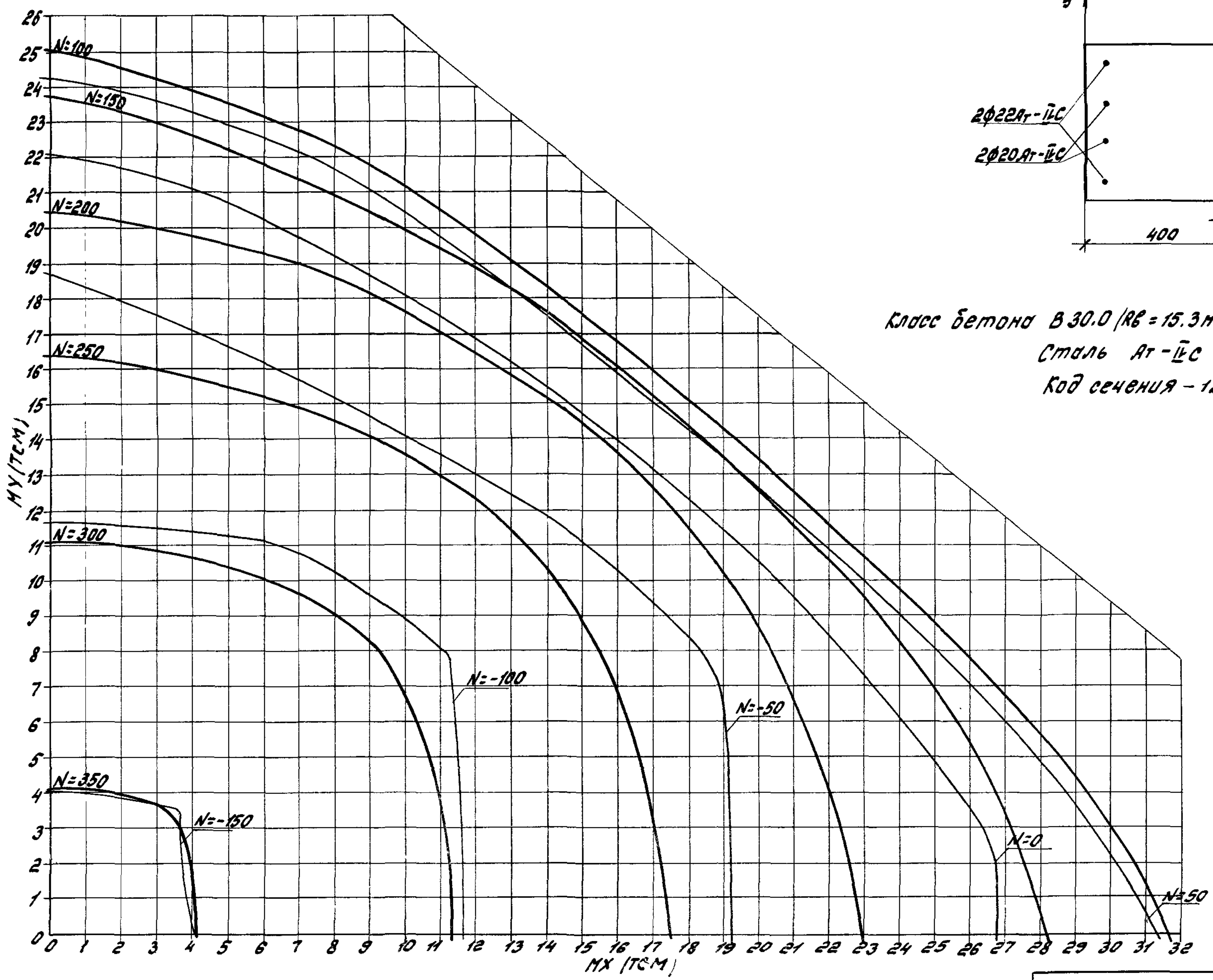

Класс бетона В30.0 ($R_b = 15.3 \text{ МПа}$ при учёте $\gamma_{b2} = 0.90$)
 Сталь А1-ЦС
 Код сечения - 1205

1.020.1-4 0-9 002

Лист	157
------	-----

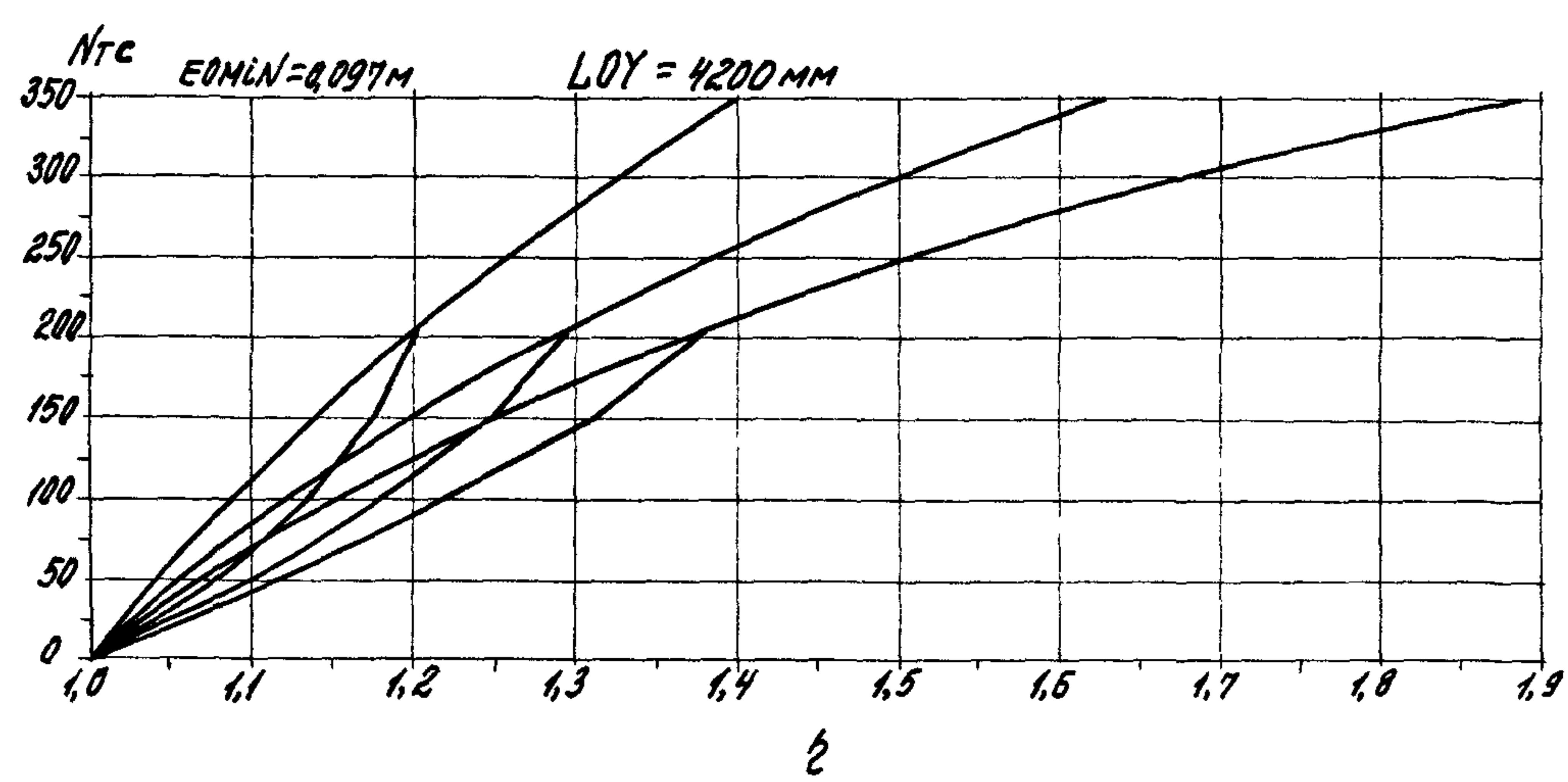
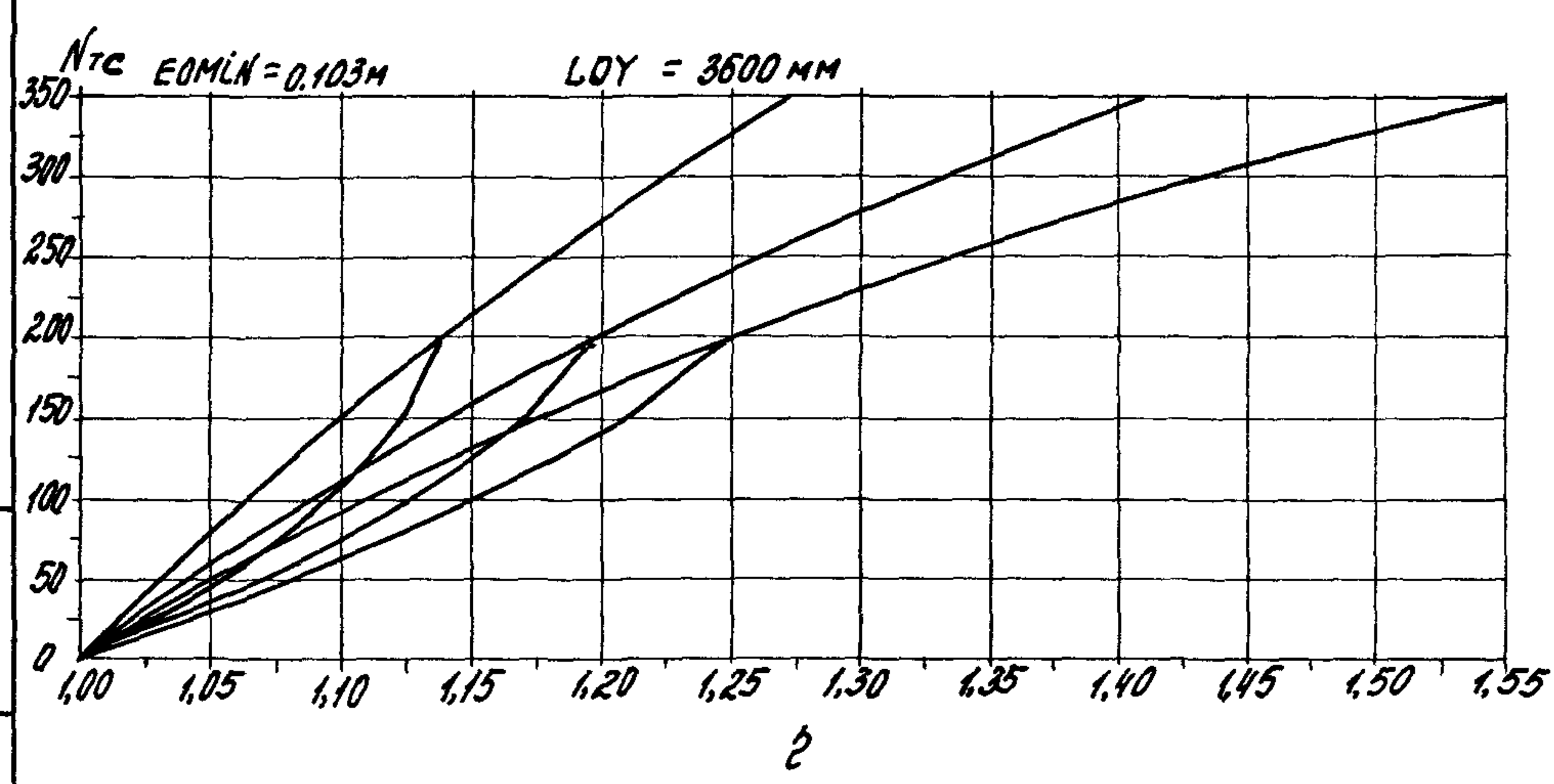
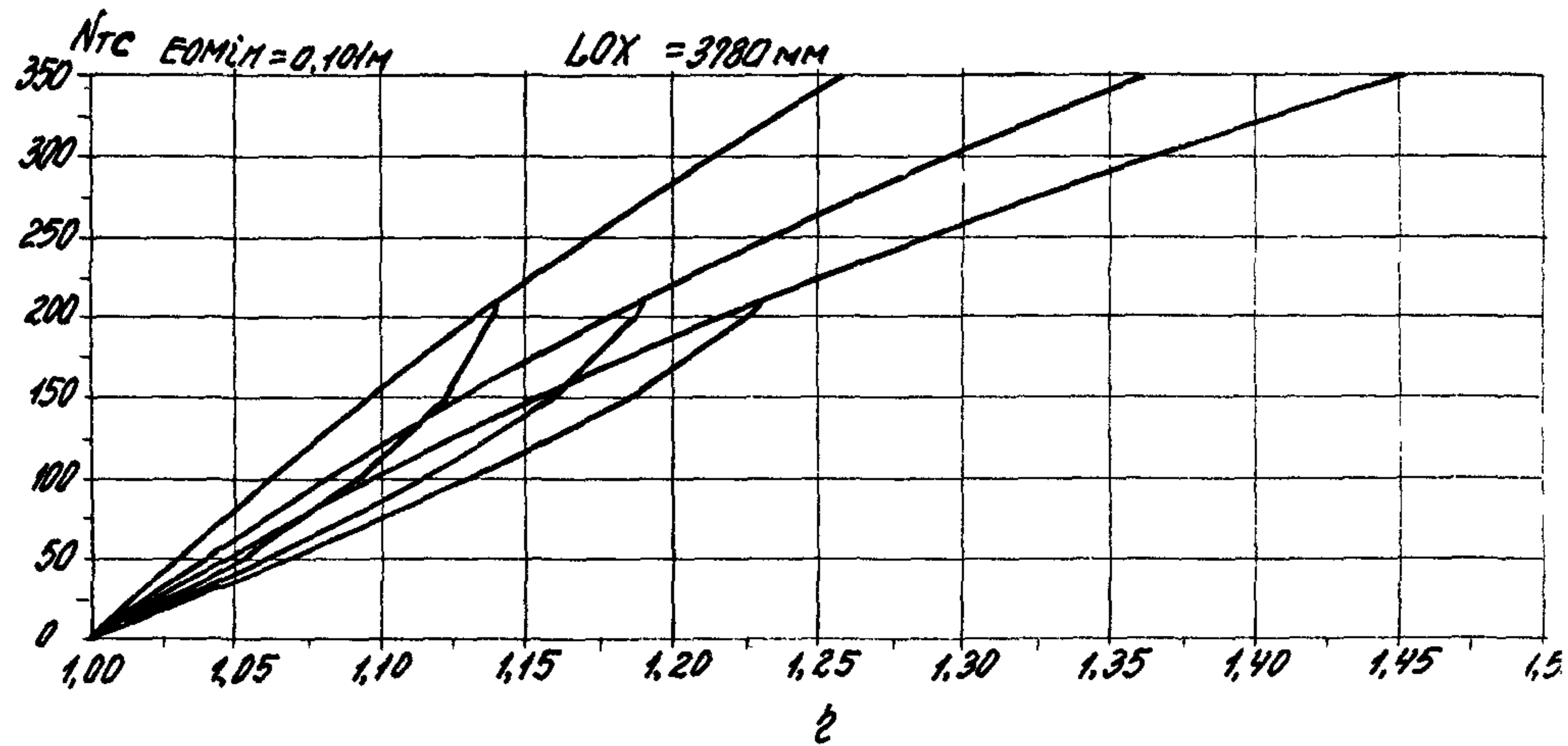
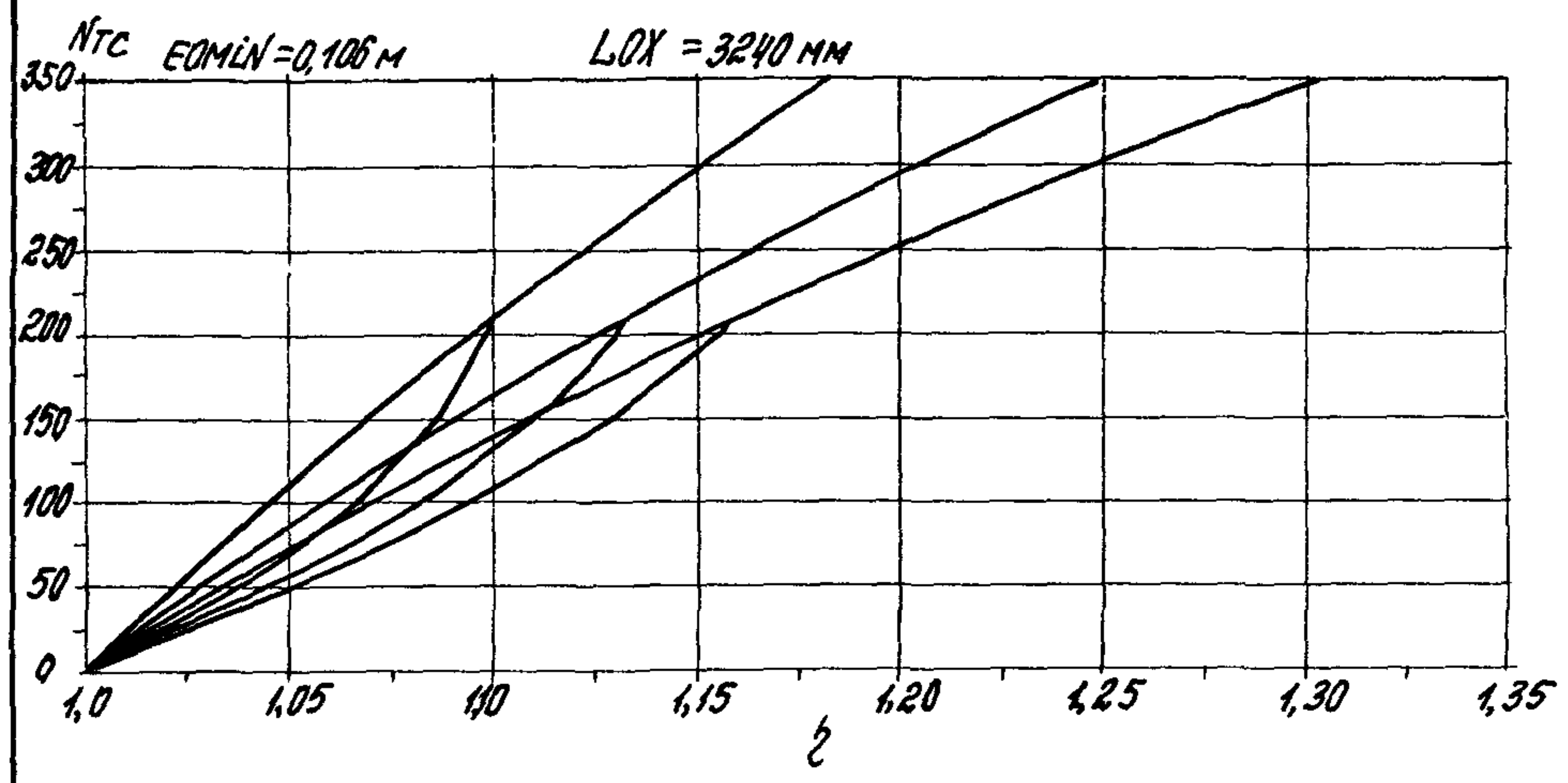

УТВЕРЖДАЮЩИЙ Исполнитель

1.020. 1-4 0-9 002	Лист
	158

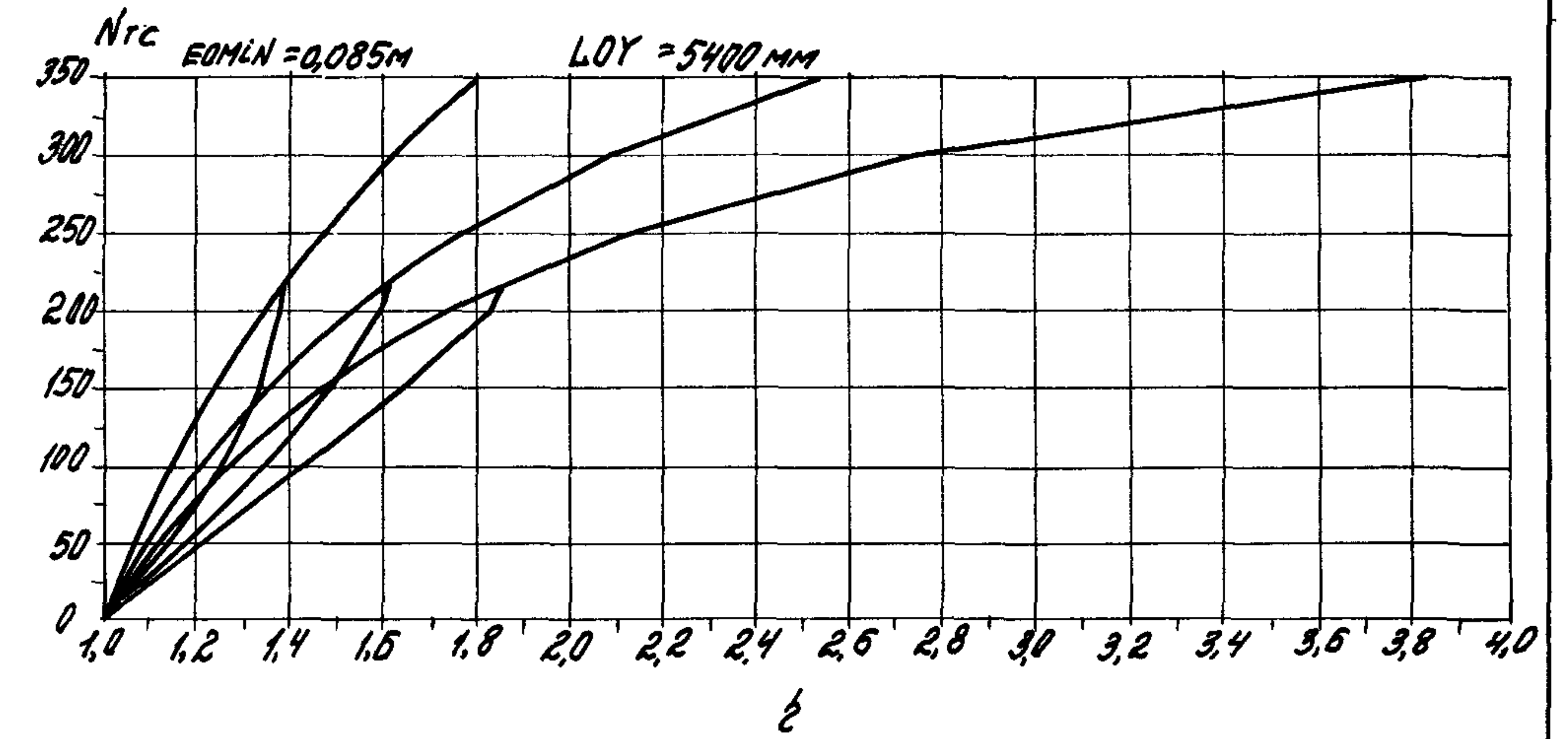
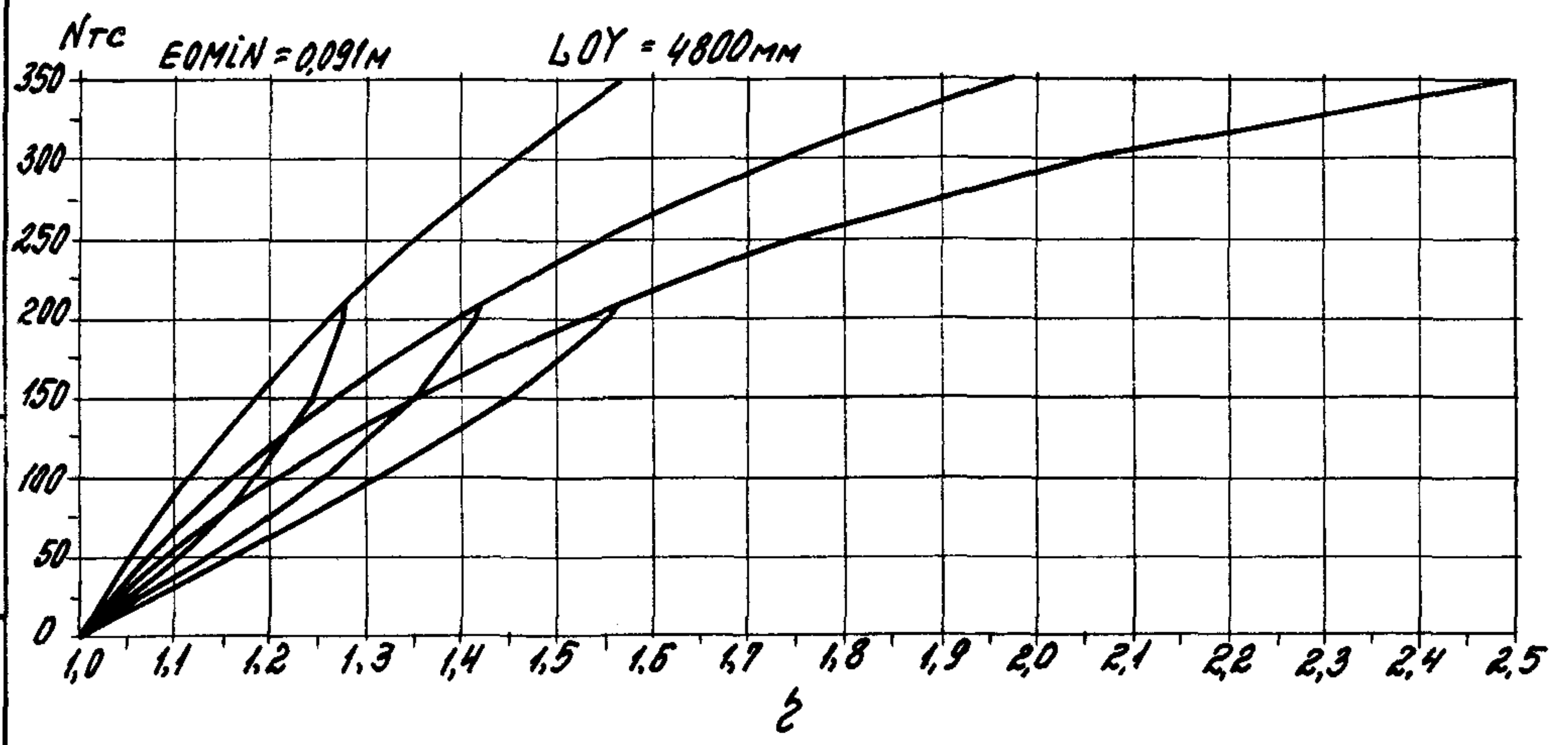
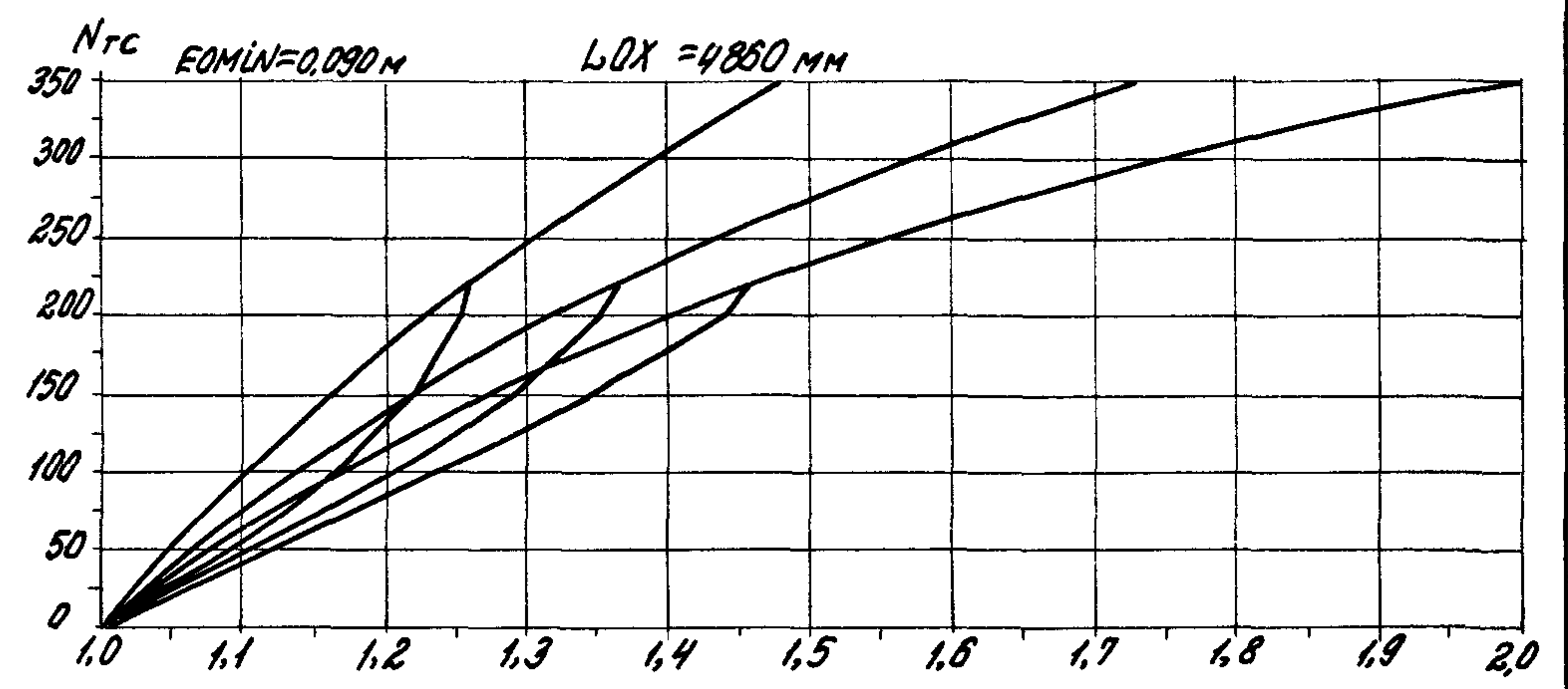
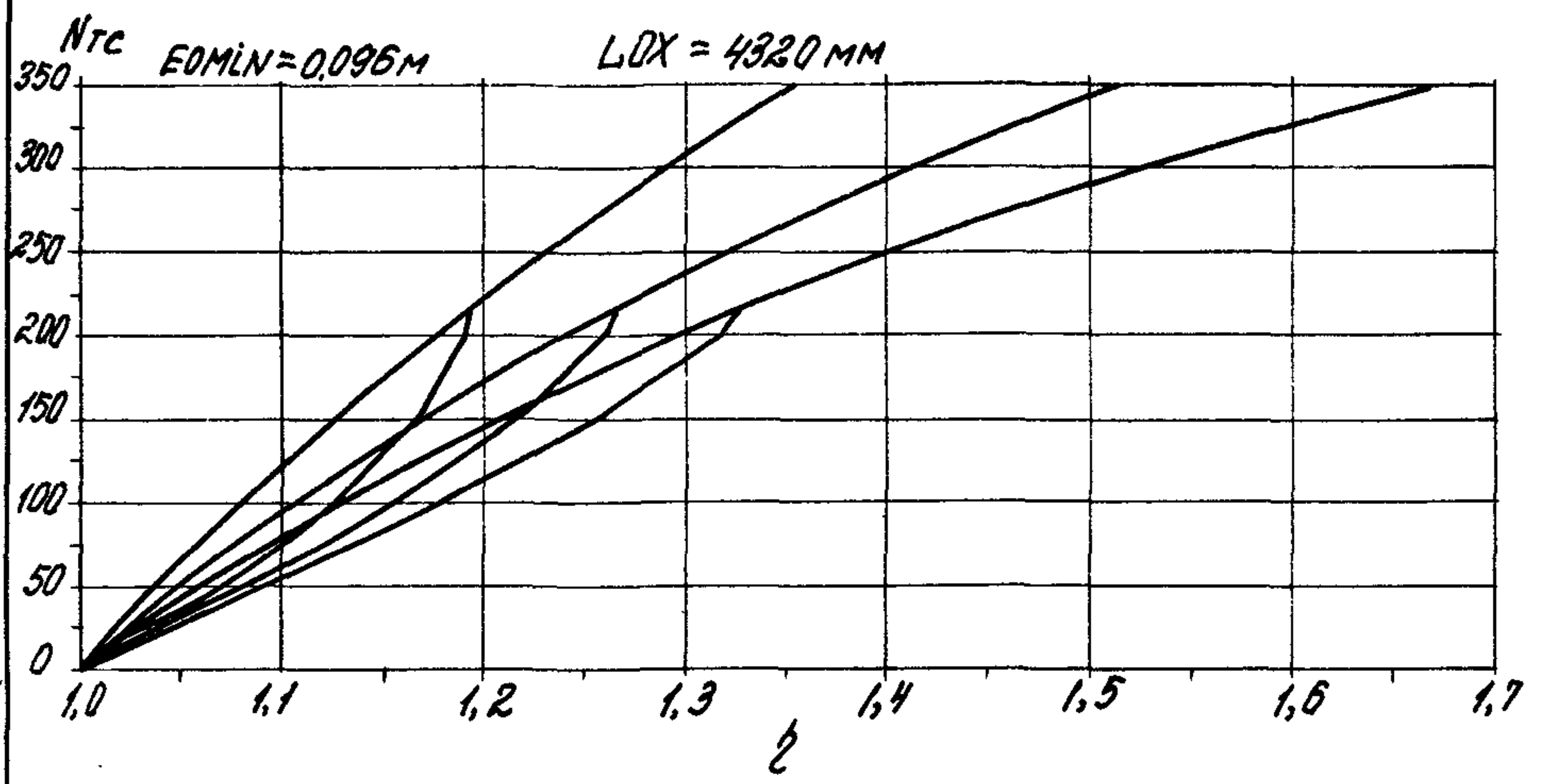

L0X=4320MM L0Y=4800MM L0Z=5400MM

1.020. 1-4 0-9 002	159
--------------------	-----

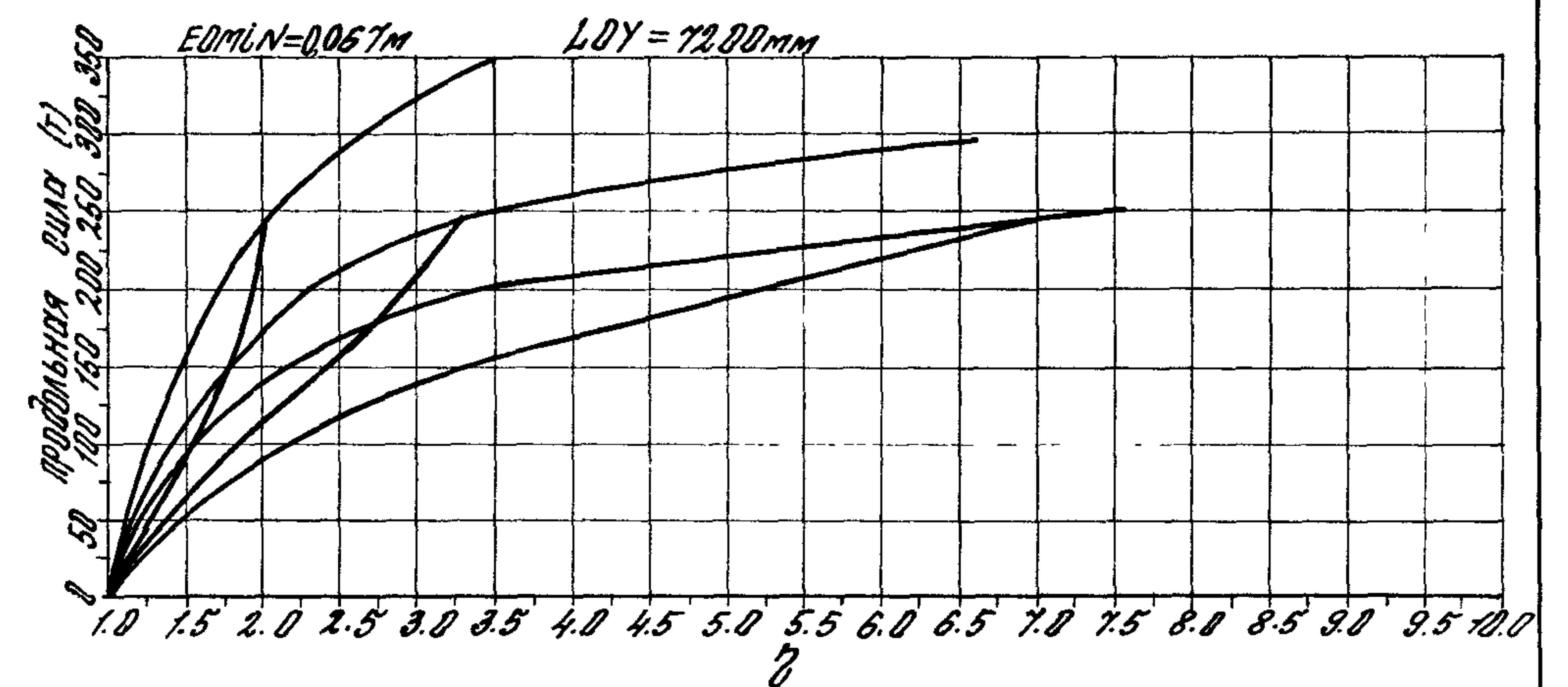
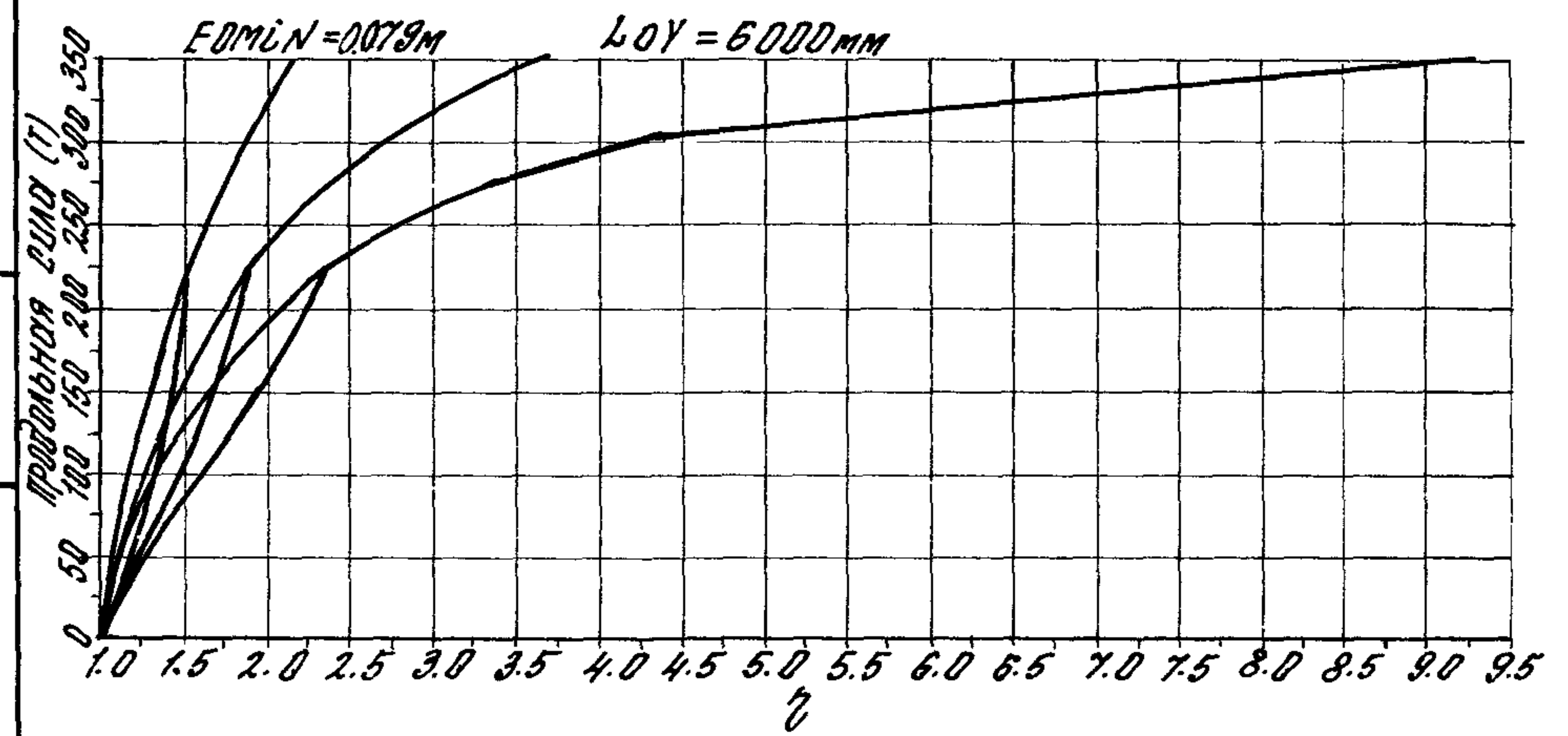
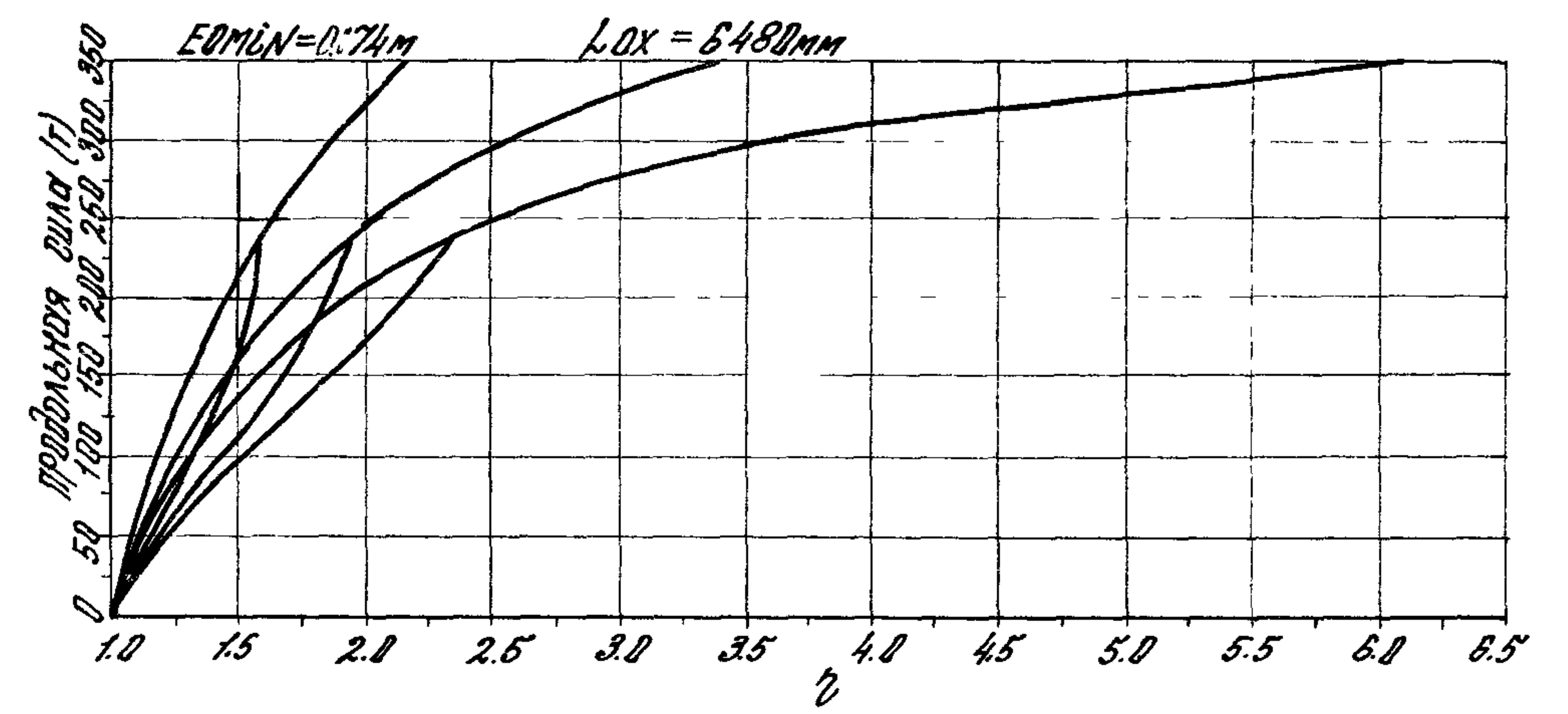
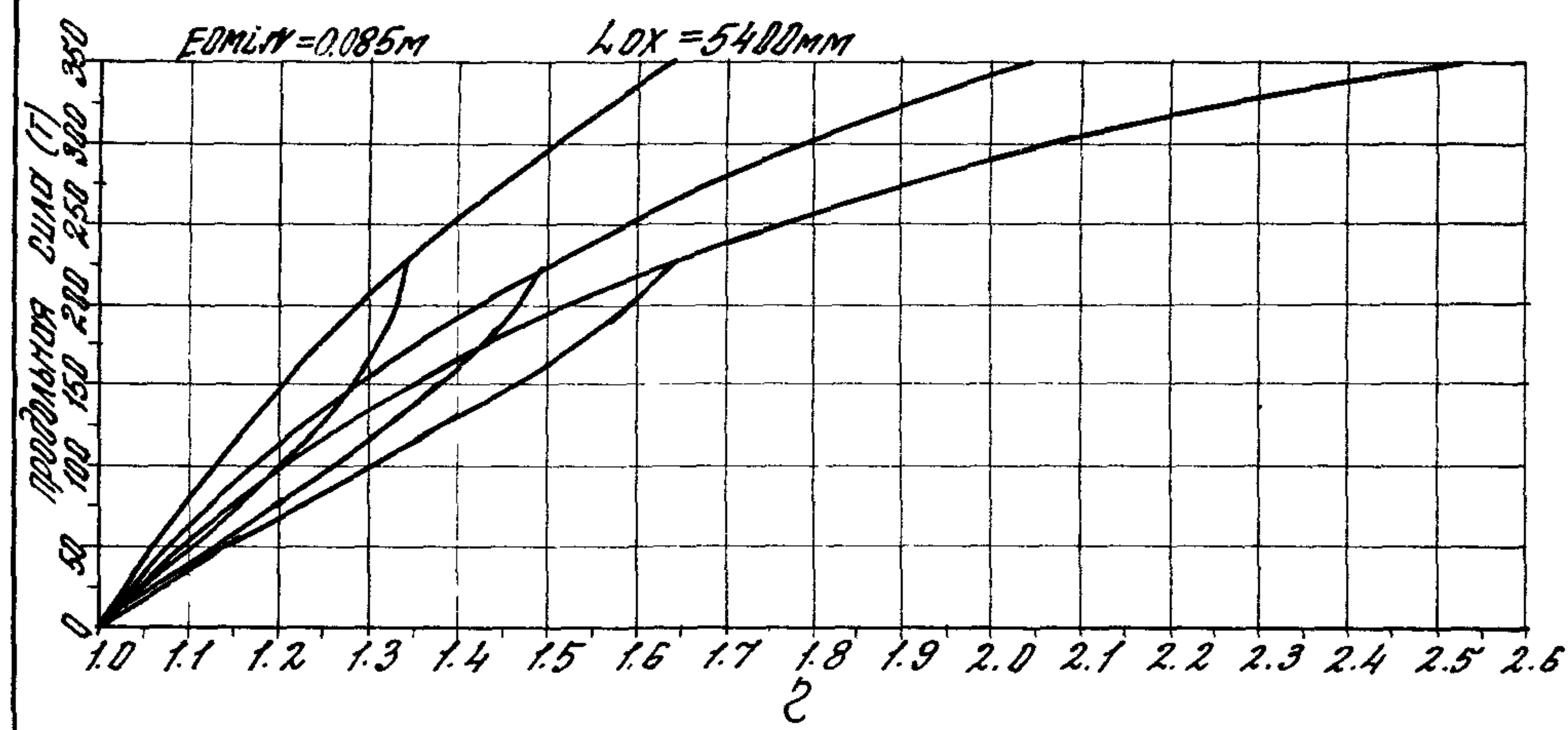

Уч. Исход. Данные и дата вычисления

1.020.1-4 0-9 002 160